

## Errata

**Title & Document Type:** 8591A/8593A Spectrum Analyzer  
Installation, Verification, and Operation Manual

**Manual Part Number:** 5958-7092

**Revision Date:** January 1990

---

### HP References in this Manual

This manual may contain references to HP or Hewlett-Packard. Please note that Hewlett-Packard's former test and measurement, semiconductor products and chemical analysis businesses are now part of Agilent Technologies. We have made no changes to this manual copy. The HP XXXX referred to in this document is now the Agilent XXXX. For example, model number HP8648A is now model number Agilent 8648A.

### About this Manual

We've added this manual to the Agilent website in an effort to help you support your product. This manual provides the best information we could find. It may be incomplete or contain dated information, and the scan quality may not be ideal. If we find a better copy in the future, we will add it to the Agilent website.

### Support for Your Product

Agilent no longer sells or supports this product. You will find any other available product information on the Agilent Test & Measurement website:

[www.tm.agilent.com](http://www.tm.agilent.com)

Search for the model number of this product, and the resulting product page will guide you to any available information. Our service centers may be able to perform calibration if no repair parts are needed, but no other support from Agilent is available.

# **Installation, Verification, and Operation Manual**

## **HP 8591A/8593A Spectrum Analyzer**

### **SERIAL NUMBERS**

This manual applies directly to HP 8591A/8593A Spectrum Analyzers with serial numbers prefixed 3003A and below, with firmware version 03.01.90 or later. If your analyzer has an earlier firmware version, see page vii, "Analyzers with Earlier Firmware Revisions."



**HP Part No. 5958-7092    Microfiche Part No. 5958-7093**  
**Printed In USA    January 1990**

---

## Safety Symbols

The following safety symbols are used throughout this manual. Familiarize yourself with each of the symbols and its meaning before operating this instrument.

---

### Caution



The *caution* sign denotes a hazard. It calls attention to a procedure which, if not correctly performed or adhered to, could result in damage to or destruction of the instrument. Do not proceed beyond a *caution* sign until the indicated conditions are fully understood and met.

---

### Warning



The *warning* sign denotes a hazard. It calls attention to a procedure which, if not correctly performed or adhered to, could result in injury or loss of life. Do not proceed beyond a *warning* sign until the indicated conditions are fully understood and met.

---

## General Safety Considerations

---

### Warning



*Before this instrument is switched on, make sure it has been properly grounded through the protective conductor of the ac power cable to a socket outlet provided with protective earth contact.*

Any interruption of the protective (grounding) conductor, inside or outside the instrument, or disconnection of the protective earth terminal can result in personal injury.

---

### Warning



There are many points in the instrument which can, if contacted, cause personal injury. Be extremely careful.

Any adjustments or service procedures that require operation of the instrument with protective covers removed should be performed only by trained service personnel.

---

### Caution



*Before this instrument is switched on, make sure its primary power circuitry has been adapted to the voltage of the ac power source.*

Failure to set the ac power input to the correct voltage could cause damage to the instrument when the ac power cable is plugged in.

---

## HP 8591A/8593A Spectrum Analyzer Documentation Description

### Manuals Shipped with Your HP 8591A or HP 8593A

#### HP 8591A/8593A Installation, Verification, and Operation Manual

Describes how to install the HP 8591A or HP 8593A Spectrum Analyzer.  
Tells how to make measurements with your HP 8591A or HP 8593A Spectrum Analyzer.  
Describes analyzer features.  
Details what to do in case of a failure.

#### HP 8591A/8593A Quick Reference Guide

Describes how to make a simple measurement with the HP 8591A or HP 8593A.  
Briefly describes the analyzer functions.  
Lists all the programming commands.

### Options

#### Option 910: Installation, Verification, and Operation Manual and Quick Reference Guide

Provides an additional copy of the *HP 8591A/8593A Spectrum Analyzer Installation, Verification, and Operation Manual* and the *HP 8591A/8593A Spectrum Analyzer Quick Reference Guide*.

#### HP 8591A, Option 915: Service Manual and Component-Level Information

Describes troubleshooting and repair of the HP 8591A.  
Option 915 consists of two manuals:  
*HP 8591A Spectrum Analyzer Service Manual* describes assembly level repair of the analyzer.  
*HP 8590B/91A/92B/93A Component-Level Information* provides information for component-level repair of the analyzer.

#### HP 8593A, Option 915: Service Manual and Component-Level Information

Describes troubleshooting and repair of the HP 8593A.  
Option 915 consists of two manuals:  
*HP 8593A Spectrum Analyzer Service Manual* describes assembly level repair of the analyzer.  
*HP 8590B/91A/92B/93A Component-Level Information* provides information for component-level repair of the analyzer.

#### Options 021 and 023: Programming Manual

The *HP 8590 Series Spectrum Analyzer Programming Manual* describes analyzer operation via a remote controller (computer) for Options 021 and 023. This manual is provided when ordering either Option 021 or Option 023.

### How to Order Manuals

Each of the manuals listed above can be ordered individually. To order, contact your local HP Sales and Service Office.

---

## How to Use This Manual

### Where to Start

If you have just received the HP 8591A or HP 8593A and want to get it ready to use for the first time:

Skim Chapter 1, "Introducing the Spectrum Analyzer," for a brief introduction to the unit and its capabilities.

Thoroughly read Chapter 2, "Installation and Preparation for Use," and follow its instructions for:

- Unpacking the unit.
- Preparing it for use.
- Performing initial self-calibration routines (these are automatic self-checks and require no test equipment).

If you need to verify the unit is operating within its specifications, perform the Verification tests in Chapter 3 (for the HP 8591A) or Chapter 4 (for the HP 8593A).

Then begin Chapter 5, "Operation," to learn how to use the analyzer.

Chapter 6 contains more extensive information about the analyzer and applications for the analyzer.

Chapter 7 details the analyzer functions.

### If the Analyzer Has Been in Use

To verify that it is operating correctly or to solve an apparent problem:

- Perform the calibration routines given in Chapter 2, "Installation and Preparation for Use," for a quick indication of proper operation.
- If you have the necessary test equipment, perform the Verification tests in Chapter 3 or Chapter 4 to verify that the unit is operating within its specifications.
- If there is an apparent problem, read Chapter 8, "Problems," for hints on what may be wrong and how to solve the problem, and instructions for calling Hewlett-Packard for additional help.

### Manual Terms and Conventions

Front-panel keys appear within a box, for example, **FREQUENCY**. Softkeys appear within a shaded box, for example, **CENTER FREQ.**

## Analyzers with Earlier Firmware Revisions

This manual documents functions which may not be available with earlier versions of firmware. The following table lists functions that have been added with a firmware revision.

**Analyzer Functions Added with Firmware Revision**

Softkey Function	Option Required	First Available with Firmware Revision
ALC NTR INT XTAL	010 or 011	03.01.90
ALC TEST	010 or 011	03.01.90
AMPLTUD COR FACT		03.01.90
AMPCOR		03.01.90
CAL TRK GEN	010 or 011	03.01.90
CATALOG AMP CORR		03.01.90
CATALOG LMT LINE		03.01.90
CATALOG REGISTER		03.01.90
DELETE SEGMENT		03.01.90
EDIT DONE		03.01.90
EDIT LIMIT		03.01.90
EDIT LOWER		03.01.90
EDIT MID/DELT		03.01.90
EDIT UP/LOW		03.01.90
EDIT UPPER		03.01.90
EDIT UPR LWR		03.01.90
EXIT SHOW		03.01.90
FLAT		03.01.90
LIMIT LINES		03.01.90
LIMITS FIX REL		03.01.90
LIMITS ON OFF		03.01.90
MAN TRK ADJUST	010 or 011	03.01.90
NEW LIMIT		03.01.90
NTSC	101 and 102	03.01.90
PAL	101 and 102	03.01.90
PAL-M	101 and 102	03.01.90
POINT		03.01.90
POWERON		03.01.90
PURGE LIMITS		03.01.90
PWR SWP ON OFF		03.01.90
RECALL LIMIT		03.01.90
SAVE LIMIT		03.01.90
SECAM-L	101 and 102	03.01.90

**Analyzer Functions Added with Firmware Revision (continued)**

<b>Softkey Function</b>	<b>Option Required</b>	<b>First Available with Firmware Revision</b>
SELECT AMPLITUD		03.01.90
SELECT DLT AMPL		03.01.90
SELECT FREQ		03.01.90
SELECT LWR AMPL		03.01.90
SELECT MID AMPL		03.01.90
SELECT SEGMENT		03.01.90
SELECT TYPE		03.01.90
SELECT UPR AMPL		03.01.90
SLOPE		03.01.90
SRC ATN ON OFF	010 or 011	03.01.90
SRC PWR OFFSET	010 or 011	03.01.90
SRC PWR ON OFF	010 or 011	03.01.90
SRC PWR STP SIZE	010 or 011	03.01.90
SWP CPLG SR SA	010 or 011	03.01.90
TRACK GEN	010 or 011	03.01.90
TRACKING PEAK	010 or 011	03.01.90
TVSTND	101 and 102	03.01.90

# Contents

---

<b>1. Introducing the Spectrum Analyzer</b>	
What You'll Find in This Chapter . . . . .	1-1
Introducing the HP 8591A and HP 8593A Spectrum Analyzers . . . . .	1-1
Options and Accessories Available . . . . .	1-2
Options . . . . .	1-2
Accessories . . . . .	1-4
Analyzers Covered by This Manual . . . . .	1-7
Serial Numbers . . . . .	1-7
Specifications for the HP 8591A . . . . .	1-9
Characteristics for the HP 8591A . . . . .	1-14
Specifications for the HP 8593A . . . . .	1-22
Characteristics for the HP 8593A . . . . .	1-26
Electrostatic Discharge . . . . .	1-32
Reducing Damage Caused by ESD . . . . .	1-33
<b>2. Installation and Preparation for Use</b>	
What You'll Find in This Chapter . . . . .	2-1
Getting Ready . . . . .	2-1
Initial Inspection . . . . .	2-1
Preparing the Analyzer for Use . . . . .	2-3
Power Requirements . . . . .	2-3
Setting the Line Voltage Selector Switch . . . . .	2-4
Checking the Fuse . . . . .	2-4
Power Cable . . . . .	2-5
Turning on the Analyzer for the First Time . . . . .	2-7
Inserting a Memory Card . . . . .	2-9
Changing the Memory Card Battery . . . . .	2-10
Analyzer Battery Information . . . . .	2-12
<b>3. Verifying Specified Operation for the HP 8591A</b>	
What You'll Find in This Chapter . . . . .	3-1
What is Performance Verification? . . . . .	3-1
What Is Operation Verification? . . . . .	3-2
Before You Start the Verification Tests . . . . .	3-2
Test Equipment You'll Need . . . . .	3-3
Recording the Test Results . . . . .	3-3
If the Analyzer Doesn't Meet Specifications . . . . .	3-3
Periodically Verifying Operation . . . . .	3-3
1. 10 MHz Reference Accuracy (Standard Timebase) . . . . .	3-8
2. Frequency Readout Accuracy and Marker Count Accuracy . . . . .	3-12
3. Noise Sidebands . . . . .	3-15
4. Residual FM . . . . .	3-18



5. System Related Sidebands . . . . .	3-21
6. Frequency Span Readout Accuracy . . . . .	3-23
7. Sweep Time Accuracy . . . . .	3-27
8. Scale Fidelity . . . . .	3-30
9. Input Attenuator Accuracy . . . . .	3-36
10. Reference Level Accuracy . . . . .	3-39
11. Resolution Bandwidth Switching Uncertainty . . . . .	3-44
12. Calibrator Amplitude Accuracy . . . . .	3-46
13. Frequency Response . . . . .	3-50
14. Spurious Response . . . . .	3-58
15. Gain Compression . . . . .	3-63
16. Displayed Average Noise Level . . . . .	3-66
17. Residual Responses . . . . .	3-72
18. 10 MHz Reference Output Accuracy (Option 004) . . . . .	3-75
19. Fast Time Domain Sweeps (Option 101) . . . . .	3-78
20. Absolute Amplitude, Vernier, and Power Sweep Accuracy . . . . .	3-82
21. Output Attenuator Accuracy . . . . .	3-86
22. Tracking Generator Level Flatness . . . . .	3-89
23. Harmonic Spurious Outputs . . . . .	3-93
24. Non-Harmonic Spurious Outputs . . . . .	3-97
25. Tracking Generator Feedthrough . . . . .	3-102
Performance Verification Test Record . . . . .	3-106
<b>4. Verifying Specified Operation for the HP 8593A</b>	
What You'll Find in This Chapter . . . . .	4-1
What is Performance Verification? . . . . .	4-1
What Is Operation Verification? . . . . .	4-2
Before You Start the Verification Tests . . . . .	4-2
Test Equipment You'll Need . . . . .	4-2
Recording the Test Results . . . . .	4-3
If the Analyzer Doesn't Meet Specifications . . . . .	4-3
Periodically Verifying Operation . . . . .	4-3
1. 10 MHz Reference Accuracy (Standard Timebase) . . . . .	4-8
2. Comb Generator Frequency Accuracy . . . . .	4-12
3. Frequency Readout Accuracy and Marker Count Accuracy . . . . .	4-14
4. Noise Sidebands . . . . .	4-18
5. System Related Sidebands . . . . .	4-21
6. Residual FM . . . . .	4-23
7. Frequency Span Readout Accuracy . . . . .	4-26
8. Sweep Time Accuracy . . . . .	4-30
9. Scale Fidelity . . . . .	4-33
10. Input Attenuator Accuracy . . . . .	4-39
11. Reference Level Accuracy . . . . .	4-42
12. Resolution Bandwidth Switching Uncertainty . . . . .	4-47
13. Calibrator Amplitude Accuracy . . . . .	4-50
14. Frequency Response . . . . .	4-54
15. Other Input Related Spurious . . . . .	4-74
16. Spurious Response . . . . .	4-80
17. Gain Compression . . . . .	4-90
18. Displayed Average Noise Level . . . . .	4-94
19. Residual Responses . . . . .	4-101

20. 10 MHz Reference Output Accuracy (Option 004) . . . . .	4-104
21. Fast Time Domain Sweeps (Option 101) . . . . .	4-107
Performance Verification Test Record . . . . .	4-111
5. <b>Operation</b>	
What You'll Learn in this Chapter . . . . .	5-1
Getting Acquainted with the Analyzer . . . . .	5-1
Front-Panel Feature Overview . . . . .	5-1
Rear-Panel Features . . . . .	5-4
Menu and Softkey Overview . . . . .	5-6
Making a Measurement . . . . .	5-6
Measurement Summary . . . . .	5-9
Screen Annotation . . . . .	5-10
Improving Accuracy with Self-Calibration Routines . . . . .	5-12
Warm-Up Time . . . . .	5-12
Performing the Tracking Generator Self-Calibration Routine . . . . .	5-13
Performing the YTF Self-Calibration Routine (HP 8593A Only) . . . . .	5-14
When Is Self-Calibration Needed? . . . . .	5-14
Saving and Recalling Data from Analyzer Memory . . . . .	5-15
To Save a State . . . . .	5-15
To Recall a State . . . . .	5-15
To Save a Trace . . . . .	5-16
To Recall a Trace . . . . .	5-16
To Save a Limit-Line Table or Amplitude Correction Factors . . . . .	5-17
To Recall Limit-Line Tables or Amplitude Correction Factors . . . . .	5-17
Saving and Recalling Data from the Memory Card . . . . .	5-19
Preparing the Memory Card for Use . . . . .	5-20
To Enter a Prefix . . . . .	5-21
To Save a State . . . . .	5-21
To Recall a State . . . . .	5-22
To Save a Trace . . . . .	5-22
To Recall a Trace . . . . .	5-23
To Save Limit-Line Tables or Amplitude Correction Factors . . . . .	5-23
To Recall Limit-Line Tables or Amplitude Correction Factors . . . . .	5-24
Saving and Recalling Programs with a Memory Card . . . . .	5-24
To Save Programs . . . . .	5-24
To Recall Programs . . . . .	5-25
Using Limit-Line Functions . . . . .	5-27
Procedure for Creating an Upper Limit-Line . . . . .	5-28
Limit-Line Functions . . . . .	5-30
Editing or Viewing the Limit-Line Tables . . . . .	5-30
Selecting the Type of Limit-Line Table . . . . .	5-30
Selecting the Limit-Line Table Format . . . . .	5-30
Selecting the Segment Number . . . . .	5-31
Selecting the Frequency Coordinate . . . . .	5-32
Selecting the Amplitude Coordinate . . . . .	5-33
Selecting the Segment Type . . . . .	5-33
Completing Table Entry and Activating Limit-Line Testing . . . . .	5-35
Saving or Recalling Limit-Line Tables with <b>SAVE LIMIT</b> and . . . . .	5-35
Procedure for Entering an Upper and Lower Limit-Line . . . . .	5-35
Entering Amplitude Correction Factors . . . . .	5-37

Changing the Analyzer's Power-On State . . . . .	5-39
Using the External Keyboard . . . . .	5-39
To Enter a Screen Title . . . . .	5-39
To Enter Programming Commands . . . . .	5-40
To Enter a Prefix . . . . .	5-40
<b>6. Analyzer Measurements and Applications</b>	
What You'll Learn in This Chapter . . . . .	6-1
Resolving Signals of Equal Amplitude with Resolution Bandwidth . . . . .	6-2
Resolving Small Signals Hidden by Large Signals with the Resolution Bandwidth Function . . . . .	6-4
Increasing the Frequency Readout Resolution Using the Marker Counter . . . . .	6-6
Decreasing the Frequency Span Using the Signal Track Function . . . . .	6-7
Peaking Signal Amplitude with Preselector Peak (HP 8593A Only) . . . . .	6-8
Tracking Unstable Signals with Signal Track while Using Maximum Hold and Minimum Hold . . . . .	6-9
Comparing Signals with Delta Markers . . . . .	6-12
Measuring Low-Level Signals with Attenuation, Video Bandwidth, and Video Averaging . . . . .	6-16
Identifying Distortion Products Using the RF Attenuator and Traces . . . . .	6-22
Distortion from the Analyzer . . . . .	6-22
Third-Order Intermodulation Distortion . . . . .	6-24
Using the Analyzer As a Receiver in Zero Frequency Span . . . . .	6-26
Measuring Amplitude Modulation with the Fast Fourier Transform Function . . . . .	6-28
Measuring Signals Near Band Boundaries with Harmonic Lock (HP 8593A Only) . . . . .	6-32
Stimulus-Response Measurements (HP 8591A with Option 010 or 011 Only) . . . . .	6-34
What Are Stimulus-Response Measurements? . . . . .	6-34
Spectrum Analyzer Functions Used . . . . .	6-35
Stepping Through the Measurement . . . . .	6-35
Demodulating and Listening to an AM or FM Signal (Option 102 only) . . . . .	6-41
Triggering on a Selected Line of a Video Picture Field (Options 101 and 102 Only) . . . . .	6-43
<b>7. Analyzer Functions</b>	
What You'll Learn in This Chapter . . . . .	7-1
Analyzer Functions . . . . .	7-11
Data Controls . . . . .	7-52
Hold Key . . . . .	7-52
Knob . . . . .	7-52
Number/Units Keypad . . . . .	7-52
Step Keys . . . . .	7-53
Front-Panel Controls and Fine-Focus Control . . . . .	7-53
Front-Panel Controls . . . . .	7-53
VOL-INTEN . . . . .	7-53
Line Power . . . . .	7-53
Fine Focus Control . . . . .	7-53
Front-Panel Connectors . . . . .	7-54
Rear-Panel Connectors . . . . .	7-55

<b>8. Problems</b>	
What You'll Find in This Chapter . . . . .	8-1
Before You Call Hewlett-Packard . . . . .	8-1
Check the Basics . . . . .	8-1
Read the Warranty . . . . .	8-3
Service Options . . . . .	8-4
How to Call Hewlett-Packard . . . . .	8-4
How to Return Your Analyzer for Service . . . . .	8-6
Service Tag . . . . .	8-6
Original Packaging . . . . .	8-6
Other Packaging . . . . .	8-6
<b>A. Analyzer Error Messages</b>	
<b>B. SRQ</b>	
Service Requests . . . . .	B-1
Status Byte Definition . . . . .	B-1
Service Request Activating Commands . . . . .	B-2

**Index**

**HP 8591A/8593A Spectrum Analyzer Mode Menu**

## Figures

---

1-1. The HP 8593A Spectrum Analyzer . . . . .	1-1
1-2. Typical Serial Number Label . . . . .	1-8
1-3. Example of a Static-Safe Work Station . . . . .	1-32
2-1. HP 8591A/8593A Packaging . . . . .	2-2
2-2. Setting the Line Voltage Selector Switch . . . . .	2-4
2-3. Checking the Line Fuse . . . . .	2-5
2-4. Reference Connector . . . . .	2-7
2-5. Inserting the Memory Card . . . . .	2-10
2-6. Memory Card Battery Date Code Location . . . . .	2-11
2-7. Memory Card Battery Replacement . . . . .	2-12
2-8. Rear-Panel Battery Information Label . . . . .	2-13
3-1. 10 MHz Reference Accuracy Test Setup (Standard Reference) . . . . .	3-9
3-2. Frequency Readout Accuracy Test Setup . . . . .	3-13
3-3. Noise Sidebands Test Setup . . . . .	3-16
3-4. Residual FM Test Setup . . . . .	3-19
3-5. System Related Sidebands Test Setup . . . . .	3-22
3-6. Frequency Span Accuracy Test Setup . . . . .	3-24
3-7. Sweep Time Accuracy Test Setup . . . . .	3-28
3-8. Scale Fidelity Test Setup . . . . .	3-31
3-9. Input Attenuator Accuracy Test Setup . . . . .	3-37
3-10. Reference Level Accuracy Test Setup . . . . .	3-40
3-11. Resolution Bandwidth Switching Uncertainty Test Setup . . . . .	3-44
3-12. LPF Characterization . . . . .	3-48
3-13. Calibrator Amplitude Accuracy Test Setup . . . . .	3-49
3-14. System Characterization Test Setup ( <i>Option 001</i> ) . . . . .	3-51
3-15. Frequency Response Test Setup, $\geq 50$ MHz . . . . .	3-52
3-16. Frequency Response Test Setup, $\geq 50$ MHz, for Option 001 . . . . .	3-52
3-17. Frequency Response Test Setup ( $< 50$ MHz) . . . . .	3-54
3-18. Second Harmonic Distortion Test Setup, 30 MHz . . . . .	3-59
3-19. Third Order Intermodulation Distortion Test Setup . . . . .	3-61
3-20. Gain Compression Test Setup . . . . .	3-64
3-21. Displayed Average Noise Level Test Setup . . . . .	3-67
3-22. Residual Response Test Setup . . . . .	3-72
3-23. 10 MHz Reference Accuracy Test Setup, Option 004 . . . . .	3-76
3-24. Fast Sweep Time Amplitude Test Setup . . . . .	3-79
3-25. Fast Sweep Time Test Setup, Option 101 . . . . .	3-80
3-26. Absolute Amplitude, Vernier, and Power Sweep Accuracy Test Setup . . . . .	3-83
3-27. Output Attenuator Accuracy Test Setup . . . . .	3-87
3-28. Tracking Generator Level Flatness Test Setup . . . . .	3-90
3-29. Harmonic Spurious Outputs Test Setup . . . . .	3-94
3-30. Non-Harmonic Spurious Outputs Test Setup . . . . .	3-98
3-31. Tracking Generator Feedthrough Test Setup . . . . .	3-103

4-1. 10 MHz Reference Accuracy Test Setup (Standard Reference)	4-9
4-2. Comb Generator Frequency Accuracy Test Setup	4-12
4-3. Frequency Readout Accuracy Test Setup	4-15
4-4. Noise Sidebands Test Setup	4-18
4-5. System Related Sidebands Test Setup	4-21
4-6. Residual FM Test Setup	4-23
4-7. Frequency Span Accuracy Test Setup (Spans $\geq 500$ MHz)	4-27
4-8. Frequency Span Accuracy Test Setup (Spans $< 500$ MHz)	4-28
4-9. Sweep Time Accuracy Test Setup	4-31
4-10. Scale Fidelity Test Setup	4-34
4-11. Input Attenuator Accuracy Test Setup	4-40
4-12. Reference Level Accuracy Test Setup	4-43
4-13. Resolution Bandwidth Switching Uncertainty Test Setup	4-48
4-14. LPF Characterization	4-51
4-15. Calibrator Amplitude Accuracy Test Setup	4-52
4-16. Frequency Response Test Setup, $\geq 50$ MHz	4-55
4-17. Frequency Response Test Setup ( $< 50$ MHz)	4-60
4-18. Other Input Related Spurious Test Setup	4-75
4-19. Second Harmonic Distortion Test Setup	4-81
4-20. Second Harmonic Distortion Test Setup, $> 2.9$ GHz	4-83
4-21. Third-Order Intermodulation Distortion Test Setup	4-86
4-22. Third Order Intermodulation Distortion	4-87
4-23. Gain Compression Test Setup	4-91
4-24. Reference Offset Test Setup	4-95
4-25. Residual Response Test Setup	4-101
4-26. 10 MHz Reference Accuracy Test Setup, Option 004	4-105
4-27. Fast Sweep Time Amplitude Test Setup	4-108
4-28. Fast Sweep Time Test Setup	4-109
5-1. Front-Panel Feature Overview	5-2
5-2. HP 8591A / HP 8593A Rear-Panel Overview	5-4
5-3. Relationship between Frequency and Amplitude	5-8
5-4. Reading the Amplitude and Frequency	5-9
5-5. Screen Annotation	5-10
5-6. Inserting the Memory Card	5-20
5-7. Typical Limit-Line Display	5-27
5-8. The Completed Limit-Line Table	5-29
5-9. Limit-Line Segments	5-32
5-10. Segment Types	5-34
5-11. Upper and Lower Limit-Line Testing	5-37
6-1. Set-Up for Obtaining Two Signals	6-2
6-2. Resolving Signals of Equal Amplitude	6-3
6-3. Resolution Bandwidth Requirements for Resolving Small Signals	6-4
6-4. Signal Resolution with a 10 kHz Resolution Bandwidth	6-5
6-5. Signal Resolution with a 30 kHz Resolution Bandwidth	6-5
6-6. Using the Marker Counter	6-6
6-7. After Zooming In on the Signal	6-7
6-8. Peaking Signal Amplitude with Preselector Peak	6-8
6-9. Using Signal Tracking to Track an Unstable Signal	6-10
6-10. Viewing an Unstable Signal Using Max Hold A	6-11
6-11. Viewing an Unstable Signal With Max Hold, Clear Write, and Min Hold	6-12
6-12. Placing a Marker on the CAL OUT Signal	6-13

6-13. Using the Marker Delta Function . . . . .	6-14
6-14. Using the Delta Meas Function . . . . .	6-15
6-15. Frequency and Amplitude Difference Between Signals . . . . .	6-16
6-16. Low-Level Signal . . . . .	6-17
6-17. Using 0 dB Attenuation . . . . .	6-18
6-18. Decreasing Resolution Bandwidth . . . . .	6-19
6-19. Decreasing Video Bandwidth . . . . .	6-20
6-20. Using the Video Averaging Function . . . . .	6-21
6-21. Harmonic Distortion . . . . .	6-22
6-22. RF Attenuation of 10 dB . . . . .	6-23
6-23. No Harmonic Distortion . . . . .	6-24
6-24. Third-Order Intermodulation Equipment Setup . . . . .	6-25
6-25. Measuring the Distortion Product . . . . .	6-26
6-26. Viewing an AM Signal . . . . .	6-27
6-27. Measuring Modulation In Zero Span . . . . .	6-28
6-28. Maximum Modulation Frequency versus Sweep Time . . . . .	6-30
6-29. Using the FFT Function . . . . .	6-31
6-30. Using Harmonic Lock . . . . .	6-33
6-31. Harmonic Locking Off . . . . .	6-34
6-32. Block Diagram of a Spectrum-Analyzer/Tracking-Generator Measurement System . . . . .	6-35
6-33. Transmission Measurement Test Setup . . . . .	6-36
6-34. Tracking-Generator Output Power Activated . . . . .	6-36
6-35. Spectrum Analyzer Settings According to the Measurement Requirement . . . . .	6-37
6-36. Decrease the Resolution Bandwidth to Improve Sensitivity . . . . .	6-38
6-37. Manual Tracking Adjustment Compensates for Tracking Error . . . . .	6-39
6-38. Normalized Trace . . . . .	6-40
6-39. Measure the Rejection Range with Delta Markers . . . . .	6-40
6-40. Demodulation of an FM Signal . . . . .	6-42
6-41. Continuous Demodulation of an FM Signal . . . . .	6-43
6-42. Triggering on an Odd Field of a Video Format . . . . .	6-44
6-43. Triggering on an Even Field of a Video Format . . . . .	6-44
7-1. Memory Card Catalog Information . . . . .	7-18
7-2. Analyzer Memory Catalog Information . . . . .	7-19
7-3. Connecting a Printer to the Analyzer . . . . .	7-24
7-4. Adjusting the Fine Focus . . . . .	7-54

## Tables

---

1-1. HP 8591A Specifications . . . . .	1-9
1-2. HP 8591A Characteristics . . . . .	1-14
1-3. HP 8593A Specifications . . . . .	1-22
1-4. HP 8593A Characteristics . . . . .	1-26
1-5. Static-Safe Accessories . . . . .	1-34
2-1. Packaging Materials . . . . .	2-2
2-2. Accessories Supplied with the Analyzer (but not Shown) . . . . .	2-3
2-3. Power Requirements . . . . .	2-3
2-4. AC Power Cables Available . . . . .	2-6
3-1. Performance Verification Tests for the HP 8591A . . . . .	3-1
3-2. Operation Verification Tests for the HP 8591A . . . . .	3-2
3-3. Recommended Test Equipment . . . . .	3-4
3-4. Frequency Readout Accuracy . . . . .	3-14
3-5. Marker Count Accuracy . . . . .	3-14
3-6. Frequency Span Readout Accuracy, Spans $\geq 500$ MHz . . . . .	3-25
3-7. Frequency Span Readout Accuracy, Spans $< 500$ MHz . . . . .	3-26
3-8. Sweep Time Accuracy . . . . .	3-29
3-9. Incremental Error, Log Mode . . . . .	3-32
3-10. Scale Fidelity, Log Mode . . . . .	3-33
3-11. Scale Fidelity, Linear Mode . . . . .	3-34
3-12. Input Attenuator Accuracy . . . . .	3-38
3-13. Reference Level Accuracy, Log Mode . . . . .	3-41
3-14. Reference Level Accuracy, Linear Mode . . . . .	3-42
3-15. Resolution Bandwidth Switching Uncertainty . . . . .	3-45
3-16. Frequency Response Errors . . . . .	3-56
3-17. Frequency Response ( $< 50$ MHz) . . . . .	3-57
3-18. Displayed Average Noise Level . . . . .	3-71
3-19. Residual Responses Above Display Line . . . . .	3-74
3-20. Fast Sweep Time Accuracy . . . . .	3-81
3-21. Vernier Accuracy . . . . .	3-85
3-22. Output Attenuator Accuracy . . . . .	3-88
3-23. Tracking Generator Level Flatness . . . . .	3-92
3-24. Harmonic Spurious Responses . . . . .	3-96
3-25. Fundamental Response Amplitudes . . . . .	3-101
3-26. Non-Harmonic Responses . . . . .	3-101
3-27. TG Feedthrough . . . . .	3-105
3-28. Performance Verification Test Record . . . . .	3-106
4-1. Performance Verification Tests for the HP 8593A . . . . .	4-1
4-2. Operation Verification Tests for the HP 8593A . . . . .	4-2
4-3. Recommended Test Equipment . . . . .	4-4
4-4. Frequency Readout Accuracy . . . . .	4-16
4-5. Marker Count Accuracy . . . . .	4-17
4-6. Frequency Span Readout Accuracy, Spans $\geq 500$ MHz . . . . .	4-28



4-7. Frequency Span Readout Accuracy, Spans <500 MHz . . . . .	4-29
4-8. Sweep Time Accuracy . . . . .	4-32
4-9. Incremental Error, Log Mode . . . . .	4-35
4-10. Scale Fidelity, Log Mode . . . . .	4-36
4-11. Scale Fidelity, Linear Mode . . . . .	4-37
4-12. Input Attenuator Accuracy . . . . .	4-41
4-13. Reference Level Accuracy, Log Mode . . . . .	4-44
4-14. Reference Level Accuracy, Linear Mode . . . . .	4-46
4-15. Resolution Bandwidth Switching Uncertainty . . . . .	4-49
4-16. Frequency Response Band 0 ( $\geq 50$ MHz) . . . . .	4-63
4-17. Frequency Response Band 1 . . . . .	4-64
4-18. Frequency Response Band 2 . . . . .	4-66
4-19. Frequency Response Band 3 . . . . .	4-68
4-20. Frequency Response Band 4 . . . . .	4-70
4-21. Frequency Response Band 4, Option 026 . . . . .	4-72
4-22. Frequency Response Band 0 (<50 MHz) . . . . .	4-73
4-23. Other Input Related Spurious . . . . .	4-79
4-24. Second Harmonic Distortion . . . . .	4-85
4-25. Third Order Intermodulation Distortion . . . . .	4-89
4-26. Gain Compression . . . . .	4-93
4-27. Displayed Average Noise Level . . . . .	4-100
4-28. Residual Responses Above Display Line . . . . .	4-103
4-29. Fast Sweep Time Accuracy . . . . .	4-110
4-30. Performance Verification Test Record . . . . .	4-111
5-1. Screen Annotation . . . . .	5-11
5-2. Screen Annotation for Trace, Trigger, and Sweep Modes . . . . .	5-11
5-3. Summary of Save and Recall Operations, Analyzer Memory . . . . .	5-18
5-4. Comparison of Analyzer Memory and Memory Card Operations . . . . .	5-19
5-5. Save and Recall Functions Using Memory Card . . . . .	5-26
7-1. Index of Analyzer Functions . . . . .	7-2
7-2. Center Frequency and Span Settings for Harmonic Bands . . . . .	7-14
7-3. Memory Card Catalog Information . . . . .	7-18
7-4. Analyzer Memory Catalog Information . . . . .	7-19
7-5. Default Configuration Values . . . . .	7-26
7-6. Preset Conditions . . . . .	7-38
7-7. Preset Spectrum Conditions . . . . .	7-39
7-8. Functions of the External Keyboard Keys . . . . .	7-56
8-1. Hewlett-Packard Sales and Service Offices . . . . .	8-5
B-1. Status Byte Definition . . . . .	B-1



## Introducing the Spectrum Analyzer

---

### What You'll Find in This Chapter

This chapter introduces you to the HP 8591A and HP 8593A Spectrum Analyzers, and the options and accessories that allow you to tailor the analyzer to your specific needs. To acquaint you with your analyzer's full capabilities, the specifications and characteristics of the HP 8591A and HP 8593A are provided.

### Introducing the HP 8591A and HP 8593A Spectrum Analyzers

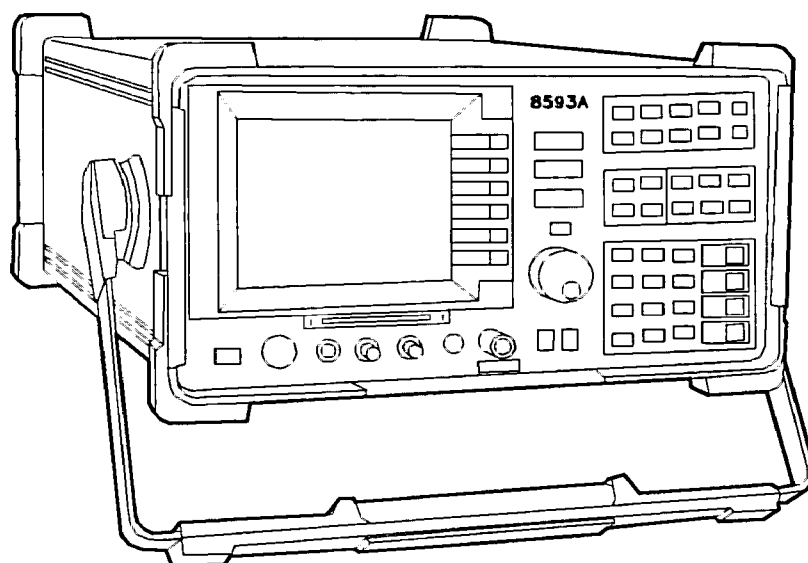

**Figure 1-1. The HP 8593A Spectrum Analyzer**

The HP 8591A and HP 8593A Spectrum Analyzers are small, lightweight test instruments that combine a wide frequency range (9 kHz to 1.8 GHz for the HP 8591A, 9 kHz to 22 GHz for the HP 8593A) and amplitude range (-115 dBm to +30 dBm for the HP 8591A, -114 dBm to +30 dBm for the HP 8593A) with over 150 easy-to-use functions to handle most RF or microwave signal measurements. In addition, they have synthesizer frequency accuracy and stability along with a built-in marker counter.

Portability and highly automatic operation make the HP 8591A or HP 8593A ideal for service and troubleshooting use in R & D labs, and in manufacturing and service environments in CATV, mobile radio, and related communications businesses.

Both the HP 8591A and the HP 8593A analyzers are complete, self-contained instruments. An ac power cable, suitable for use in the country to which the analyzer is originally shipped, is included with the unit.

---

## Options and Accessories Available

### Options

Many options are available to tailor the analyzer to your needs.

Options can be ordered by option number when you order the analyzer. Some of the options are also available as kits that can be ordered and installed after you have received your analyzer. The options are listed numerically by their option number.

#### **75 $\Omega$ Input Impedance (Option 001)**

*Option 001 is available for the HP 8591A only.* This option provides a 75 $\Omega$  input impedance instead of the standard 50 $\Omega$  impedance for the HP 8591A. Analyzers with this option use cables, circuit boards, and front panels that are different from the standard units.

#### **Precision Frequency Reference (Option 004)**

This option provides increased absolute frequency-reference accuracy because the internal oscillators are phase-locked to an internal precision-frequency reference.

Option 004 is also available as a kit (HP part number 5062-6459).

#### **Tracking Generator (Option 010 or 011)**

*Option 010 or 011 is available for the HP 8591A only.* Option 010 or 011 provides a 1.8 GHz built-in tracking generator. This source-receiver combination makes insertion-loss, frequency response, and return-loss measurements. The tracking generator has a wide distortion-free dynamic range, plus good sensitivity and selectivity. Option 010 has the standard 50 $\Omega$  input impedance, Option 011 has 75 $\Omega$  input impedance.

Option 010 or 011 is also available as a kit (HP part number 5062-6460 and 5062-6480 respectively).

#### **HP-IB (Option 021)**

Option 021 enables you to control your analyzer from a computer that uses an Hewlett-Packard interface bus (HP-IB). Such computers include the HP 9000 Series 200 and Series 300, and the HP Vectra PC. This option also enables the analyzer to control a printer or plotter. Option 021 includes a connector for an external keyboard, an HP-IB connector, and the *HP 8590 Series Spectrum Analyzer Programming Manual*.

Option 021 is also available as a kit (HP part number 5062-6454).

### **RS-232 (Option 023)**

Option 023 enables you to control your analyzer from a computer that uses an RS-232 interface bus. Such computers include the HP Vectra PC, the IBM PC, the AT, and compatibles. This option also enables the analyzer to control a printer or plotter. Option 023 includes a connector for an external keyboard, an RS-232 connector, and the *HP 8590 Series Spectrum Analyzer Programming Manual*.

Option 023 is also available as a kit (HP part number 5062-6455).

### **Frequency Range to 26.5 GHz Extension (Option 026)**

*Option 026 is available for the HP 8593A only.* The frequency range of the HP 8593A is extended from 22 GHz to 26.5 GHz. Analyzers with this option use an input connector, circuit boards, and front panels that are different from the standard units.

### **Impact Cover Assembly (Option 040)**

The impact cover assembly snaps onto the front of your analyzer to protect the front panel during travel and when the unit is not in use.

Option 040 is also available as a kit (Impact Cover Assembly, HP part number 5062-4805).

### **Soft Carrying Case (Option 042)**

Soft carrying case with a pouch for accessories. Option 042 can be used to provide additional protection during travel.

### **Fast Time Domain Sweeps (Option 101)**

Option 101 allows sweep times down to 20  $\mu$ s in zero span. In fast sweep times (sweep times less than 20 milliseconds), time domain sweeps are digitized. All trace functions are available for these fast zero-span sweeps.

Option 101 is also available as a kit (HP part number 5062-6458).

### **AM/FM Speaker and TV Sync Trigger Circuitry (Option 102)**

Option 102 enables you to use amplitude or frequency demodulation and to listen to a demodulated signal. Option 102 also allows you to TV trigger on the selected line of a TV video picture frame if both Option 101 and 102 are installed. The sweep triggering works with interlaced or noninterlaced displays for the NTSC, PAL, and SECAM formats.

Option 102 is also available as a kit (HP part number 5062-6457).

### **Rack Mount Flange Kit (Option 908)**

This option provides the parts necessary to mount the analyzer in an HP System II cabinet or in a standard 19 inch (482.6 mm) equipment rack.

Option 908 is also available as a kit (HP part number 5062-4840).

### **Rack Mount Flange Kit With Handles (Option 909)**

Option 909 is the same as Option 908 but includes front handles for added convenience.

Option 909 is also available as a kit (HP part number 5062-4841).

### **Installation, Verification, and Operation Manuals (Option 910)**

An additional copy of the *HP 8591A/8593A Spectrum Analyzer Installation, Verification, and Operation Manual* and the *HP 8591A/8593A Spectrum Analyzer Quick Reference Guide* are available as a set under Option 910.

### **Service Documentation for the HP 8591A (Option 915)**

Option 915 provides one copy of the *HP 8591A Spectrum Analyzer Service Manual* and one copy of the *HP 8590B/91A/92B/93A Component-Level Information*. The *HP 8591A Spectrum Analyzer Service Manual* describes assembly level troubleshooting procedures and adjustment procedures. The *HP 8590B/91A/92B/93A Component-Level Information* provides parts lists, component-location diagrams, and schematic diagrams for selected repairable assemblies.

The manuals can be ordered separately.

### **Service Documentation for the HP 8593A (Option 915)**

Option 915 provides one copy of the *HP 8593A Spectrum Analyzer Service Manual* and one copy of the *HP 8590B/91A/92B/93A Component-Level Information*. The *HP 8593A Spectrum Analyzer Service Manual* describes assembly level troubleshooting procedures and adjustment procedures. The *HP 8590B/91A/92B/93A Component-Level Information* provides component-level information.

The manuals can be ordered separately.

## **Accessories**

A number of accessories are available from Hewlett-Packard to help you configure your analyzer for your specific needs.

### **50 $\Omega$ Transmission/Reflection Test Set**

The HP 85044A Option H10 Transmission/Reflection test set provides the capability to simultaneously measure the impedance and transmission characteristics of 50 $\Omega$  devices. It is effective over a frequency range of 300 kHz to 3 GHz.

### **50 $\Omega$ /75 $\Omega$ Minimum Loss Pad**

The HP 11852B is a low VSWR minimum loss pad that is required for measurements on 75 $\Omega$  devices using an analyzer with a 50 $\Omega$  input. It is effective over a frequency range of dc to 2 GHz.

### **75 $\Omega$ Matching Transformer**

The HP 11694A allows you to make measurements in 75 $\Omega$  systems using an analyzer with a 50 $\Omega$  input. It is effective over a frequency range of 3 to 500 MHz.

### **AC Power Source**

The HP 85901A provides 200 watts of continuous power for field and mobile application. The self-contained ac power source has outputs for either 115 V or 230 V and runs on its own internal battery, an external battery, or on another 12 V dc source. Typical operating time exceeds 1 hour for 100 watt continuous use at room temperature.

## AC Probe

The HP 85024A High Frequency Probe performs in-circuit measurements without adversely loading the circuit under test. The probe has an input capacitance of 0.7 pF shunted by 1 M $\Omega$  of resistance. High probe sensitivity and low distortion levels allow measurements to be made while taking advantage of the full dynamic range of the analyzer.

---

## Caution



Do not use dc-coupled probes on HP 8593A analyzers; they may cause damage to the analyzer input circuit.

---

## Broadband Preamplifiers

The HP 10855A preamplifier provides a minimum of 22 dB gain from 2 MHz to 1300 MHz to enhance measurements of very low-level signals. The HP 8449A preamplifier provides a minimum of 23 dB gain from 2 GHz to 22 GHz.

## CATV Measurements Card

The HP 85711A Cable Television Measurements Card provides a quick and easy way to adapt your analyzer for making cable TV measurements while retaining spectrum analysis capability. The CATV measurements card is a downloadable program on a memory card that adds a set of eight functions to simplify cable TV testing: channel selection, carrier level, carrier-to-noise, power line hum, crossmodulation, composite triple beat, modulation depth, and system frequency response.

## Close Field Probes

The HP 11940A/11941A Close-Field Probes are small, hand-held, electromagnetic-field sensors. The probes provide repeatable, absolute, magnetic-field measurements from 30 MHz to 1 GHz with the HP 11940A, and from 9 kHz to 30 MHz with the HP 11941A. When attached to a source, the probes generate a localized magnetic field for electromagnetic interference (EMI) susceptibility testing.

## Digital Radio Measurements Card for the HP 8593A

The HP 85713A Digital Radio Measurements card provides an easy way to measure band occupancy and transmitter spurious outputs, as well as determine the sources of interference including external broadcast or multipath effects. The digital radio measurements card is a downloadable program on a memory card. It qualifies the occupied bandwidth of a modulated digital radio signal, the mean power level of unmodulated carrier, and quantifies modulator alignment.

## EMI Diagnostics Measurements Card for the HP 8591A

The HP 85712A EMI Diagnostics Measurements Card provides an easy way to find EMI “hot spots” in your new-product designs quickly and easily with the HP 11940A or HP 11941A Close-Field Probe. The EMI diagnostics measurements card is a downloadable program on a memory card. The field strength is measured directly at the probe tip in dB $\mu$ A/m, and antenna factors for the probe are automatically applied. A special function helps you to discriminate between narrowband and broadband signals.

## **External Keyboard**

*For use with Option 021 or 023.* The HP C1405 Option ABA keyboard is an IBM AT compatible keyboard that can be connected to the external keyboard connector of the rear panel of the analyzer. Screen titles and remote programming commands can be entered easily with the external keyboard.

## **External Keyboard Cable**

The HP C1405 Option 002 or 003 cable is a coiled cable that connects the external keyboard to the rear panel of the analyzer. Option 002 is a 2 meter cable; Option 003 is a 3 meter cable.

## **HP-IB Cable**

*For use with Option 021.* The HP 10833 HP-IB cables interconnect HP-IB devices and are available in four different lengths. HP-IB cables are used to connect printers, plotters, and controllers to an analyzer.

## **Memory Card, 32 kilobyte**

The HP 85700A is a blank memory card with 32 kilobytes of memory for use with the memory card reader.

## **Monitor**

The HP 82913A is a 12-inch monitor that provides a larger display for the analyzer in fixed installations.

## **Plotter**

*For use with Option 021 or 023.* The HP ColorPro 7440A Graphics Plotter adds a color plot capability to the analyzer for permanent records of important measurements. The eight-pen HP ColorPro Plotter produces color plots with 0.025 mm (0.001 inch) resolution on either 8.5 by 11 inch paper or transparency film. The plotter can be ordered with HP-IB or RS-232 interfaces to correspond to the interface option installed on the analyzer.

## **Printer**

*For use with Option 021 or 023.* The HP 2225A/B/D ThinkJet Personal Printer provides black and white printing for another form of permanent records of your test results. The HP 3630A PaintJet printer provides high-resolution color printing. The printers can be ordered with HP-IB or RS-232 interfaces to correspond to the interface option installed on the analyzer.

## **Rack Slide Kit**

This kit (HP part number 1494-0060) provides the hardware to adapt rack-mount kits (Options 908 and 909) for mounting the analyzer on slides in an HP System II cabinet.



## **RF Limiters**

The HP 11867A and HP 11693A Limiters protect the analyzer input circuits from damage due to high power levels. The HP 11867A operates over a frequency range of dc to 1800 MHz and begins reflecting signal levels over 1 milliwatt up to 10 watts average power and 100 watts peak power. The HP 11693A microwave limiter (0.1 to 12.4 GHz, usable to 18 GHz) guards against input signals over 1 milliwatt up to 1 watt average power and 10 watts peak power.

## **RS-232 Cable**

*For use with Option 023.* The HP 13242G is a 25-pin, male-to-male RS-232 cable. The HP 13242G cable can be used with the HP 7475A, HP ThinkJet, and HP LaserJet.

## **Transit Case**

The transit case (HP part number 9211-5604) provides extra protection for your analyzer for frequent travel situations. The HP transit case protects your instrument from hostile environments, shock, vibration, moisture, and impact while providing a secure enclosure for shipping.

---

## **Analyzers Covered by This Manual**

This manual applies to analyzers with the serial-number prefixes listed under “Serial Numbers” on the title page.

## **Serial Numbers**

Hewlett-Packard makes frequent improvements to its products to enhance their performance, usability, or reliability, and to control costs. HP service personnel have access to complete records of design changes to each type of equipment, based on the equipment's serial number. Whenever you contact Hewlett-Packard about your analyzer, have the complete serial number available to ensure obtaining the most complete and accurate information possible.

A Mylar serial-number label is attached to the rear of the analyzer. It contains the serial number and the options installed in the analyzer. The serial number has two parts: the prefix (the first four numbers and a letter), and the suffix (the last five numbers). See Figure 1-2.

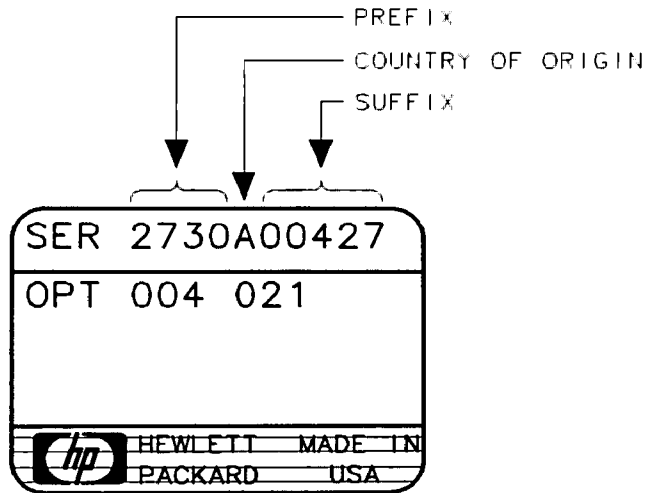

**Figure 1-2. Typical Serial Number Label**

The first four numbers of the prefix are a code that identifies the date of the last major design change that is incorporated in your analyzer. The letter identifies the country in which the unit was manufactured. The five-digit suffix is a sequential number and is different for each unit.

The option section of the serial label contains the option number(s) of the option(s) installed in the analyzer.

Whenever you specify the serial number or refer to it in obtaining information about your analyzer, be sure to use the complete number, including the full prefix and the suffix.

# Specifications for the HP 8591A

Table 1-1. HP 8591A Specifications (1 of 5)

<b>GENERAL SPECIFICATIONS</b>	
All specifications apply over 0°C to +55°C. The analyzer will meet its specifications after 2 hours of storage at a constant temperature, within the operating temperature range, 30 minutes after the analyzer is turned on and after CAL FREQ, and CAL AMPTD have been run.	
<b>Temperature Range</b> Operating Storage	0°C to +55°C -40°C to +75°C
<b>EMI Compatibility</b>	Conducted and radiated interference CISPR Pub. 11 and Messemphaenger Postverfuegung 526/527/79
<b>Audible Noise</b>	<37.5 dBA pressure and <5.0 Bels power (ISODP7779)
<b>Power Requirements</b> ON (LINE 1)  Standby (LINE 0)	86 to 127, or 195 to 250 V rms, 47 to 66 Hz 103 to 126 V rms, 400 Hz ±10% Power consumption <300 VA Power consumption <7 watts
<b>FREQUENCY SPECIFICATIONS</b>	
<b>Frequency Range</b> 50Ω 75Ω (Option 001)	9 kHz to 1.8 GHz 1 MHz to 1.8 GHz
<b>Frequency Reference</b> Aging  Settability Temperature Stability	±1 × 10 <sup>-7</sup> /day ±2 × 10 <sup>-6</sup> /year  ±0.5 × 10 <sup>-6</sup> ±5 × 10 <sup>-6</sup>
<b>Precision Freq. Reference (Option 004)</b> Aging Settability Temperature Stability	±1 × 10 <sup>-7</sup> /year ±1 × 10 <sup>-8</sup> ±1 × 10 <sup>-8</sup>

Table 1-1. HP 8591A Specifications (2 of 5)

FREQUENCY SPECIFICATIONS (Continued)									
<b>Frequency Accuracy</b> Readout Accuracy (Start, Stop, Center, Marker)	$\pm(\text{frequency readout} \times \text{frequency reference error}^* + 3\% \text{ of span} + 20\% \text{ of RBW} + 1.5 \text{ kHz})$								
<b>Marker Count Accuracy</b> Frequency Span $\leq 10$ MHz	(Signal-to-Noise ratio $\geq 25$ dB, RBW/span $\geq 0.01$ ) $\pm(\text{marker frequency} \times \text{frequency reference error}^* + \text{counter resolution} + 100 \text{ Hz})$								
Frequency Span $> 10$ MHz	$\pm(\text{marker frequency} \times \text{frequency reference error}^* + \text{counter resolution} + 1 \text{ kHz})$								
Counter Resolution	Selectable from 10 Hz to 100 kHz								
<b>Frequency Span</b> Range Resolution Accuracy	0 Hz (zero span), 10 kHz to 1.8 GHz 4 digits $\pm 2\%$ of span, spans $\leq 10$ MHz $\pm 3\%$ of span, spans $> 10$ MHz								
<b>Frequency Sweep Time</b> Range Span=0 Hz Span=0 Hz (Option 101) Span $> 10$ kHz Accuracy 20 ms to 100 s 20 $\mu$ s to $< 20$ ms (Option 101) Sweep Trigger	20 ms to 100 s 20 $\mu$ s to 100 s 20 ms to 100 s $\pm 3\%$ $\pm 2\%$ Free run, Single, Line, Video, External								
<b>Stability</b> Noise Sidebands  Residual FM System Related Sidebands	$\leq -95$ dBc/Hz at $> 30$ kHz offset from CW signal (1 kHz RBW, 30 Hz VBW, and sample detector)  $< 250$ Hz pk-pk in 100 ms (1 kHz RBW, 1 kHz VBW) $\leq -65$ dBc at $> 30$ kHz offset from CW signal								
AMPLITUDE SPECIFICATIONS									
<b>Amplitude Range</b> 50 $\Omega$ 75 $\Omega$ (Option 001)	$-115$ dBm to $+30$ dBm $-63$ dBmV to $+75$ dBmV								
<b>Maximum Safe Input Level</b>  Average Continuous Power Peak Pulse Power dc	(Input Atten $\geq 10$ dB) <table style="width: 100%; border: none;"> <tr> <td style="width: 50%; text-align: center;"><b>50<math>\Omega</math></b></td> <td style="width: 50%; text-align: center;"><b>75<math>\Omega</math> (Option 001)</b></td> </tr> <tr> <td style="text-align: center;">+30 dBm (1 watt)</td> <td style="text-align: center;">+75 dBmV (0.4 watts)</td> </tr> <tr> <td style="text-align: center;">+30 dBm (1 watt)</td> <td style="text-align: center;">+75 dBmV (0.4 watts)</td> </tr> <tr> <td style="text-align: center;">25 V dc</td> <td style="text-align: center;">100 V dc</td> </tr> </table>	<b>50<math>\Omega</math></b>	<b>75<math>\Omega</math> (Option 001)</b>	+30 dBm (1 watt)	+75 dBmV (0.4 watts)	+30 dBm (1 watt)	+75 dBmV (0.4 watts)	25 V dc	100 V dc
<b>50<math>\Omega</math></b>	<b>75<math>\Omega</math> (Option 001)</b>								
+30 dBm (1 watt)	+75 dBmV (0.4 watts)								
+30 dBm (1 watt)	+75 dBmV (0.4 watts)								
25 V dc	100 V dc								
* Frequency Reference Error = (aging rate $\times$ period of time since adjustment + initial achievable accuracy + temperature stability) See Table 1-2									

**Table 1-1. HP 8591A Specifications (3 of 5)**

<b>AMPLITUDE SPECIFICATIONS (continued)</b>	
<b>Gain Compression</b> >10 MHz	≤0.5 dB (total power at input mixer* = -10 dBm)
<b>Displayed Average Noise Level</b>  400 kHz to 1 MHz 1 MHz to 1.5 GHz 1.5 GHz to 1.8 GHz	(Input terminated, 0 dB attenuation, 1 kHz RBW, 30 Hz VBW, sample detector) <b>50Ω</b> <b>75Ω (Option 001)</b> ≤-115 dBm      N/A ≤-115 dBm      ≤-63 dBmV ≤-113 dBm      ≤-61 dBmV
<b>Spurious Responses</b> Second Harmonic Distortion 5 MHz to 1.8 GHz  Third Order Intermodulation Distortion 5 MHz to 1.8 GHz  Other Input Related Spurious	<-70 dBc for -45 dBm tone power at input mixer*  <-70 dBc for two -30 dBm tones at input mixer* and >50 kHz separation  <-65 dBc for ≥30 kHz offset from CW signal
<b>Residual Responses</b>  150 kHz to 1 MHz 1 MHz to 1.8 GHz	(Input terminated and 0 dB attenuation) <b>50Ω</b> <b>75Ω (Option 001)</b> <-90 dBm      N/A <-90 dBm      <-38 dBmV
<b>Display Range</b> Log Scale  Linear Scale  Scale Units  Marker Readout Resolution  Fast Sweep Times for Zero Span 20 μs to 20 ms (Option 101)	0 to -70 dB from reference level is calibrated, 1 to 20 dB/division in 1 dB steps; 8 divisions displayed  8 divisions  dBm, dBmV, dBμV, volts and watts  0.05 dB for log scale 0.05% of reference level for linear scale  0.7% of reference level for linear scale
* Mixer Power Level (dBm) = Input Power (dBm) - Input Attenuator (dB).	

**Table 1-1. HP 8591A Specifications (4 of 5)**

<b>AMPLITUDE SPECIFICATIONS (Continued)</b>	
<b>Reference Level</b> Range 50Ω 75Ω ( <i>Option 001</i> ) Resolution  Accuracy 0 dBm to -59.9 dBm -60 dBm to -115 dBm	-115 dBm to +30 dBm -63 dBmV to +75 dBmV 0.01 dB for log scale 0.12% of reference level for linear scale  (Referred to -20 dBm Reference Level) ±(0.5 dB + Input Attenuator Accuracy at 50 MHz) ±(1.25 dB + Input Attenuator Accuracy at 50 MHz)
<b>Frequency Response</b> Absolute Relative Flatness	(10 dB input attenuation) ±1.5 dB, referred to 300 MHz CAL OUT ±1.0 dB, referred to midpoint between highest and lowest frequency response deviations
<b>Calibrator Output</b> Frequency Amplitude 50Ω 75Ω ( <i>Option 001</i> )	300 MHz ± (300 MHz × frequency reference error)*  -20 dBm ±0.4 dB +28.75 dBmV ±0.4 dB
<b>Input Attenuator</b> Range Accuracy 20 to 50 dB 60 dB	0 to 60 dB, in 10 dB steps  ±0.5 dB at 50 MHz, referred to 10 dB attenuation ±0.75 dB at 50 MHz, referred to 10 dB attenuation
<b>Resolution Bandwidth Switching</b> Uncertainty 3 kHz to 3 MHz RBW 1 kHz	(Referred to 3 kHz RBW)  ±0.4 dB ±0.5 dB
<b>Log to Linear Switching</b>	±0.25 dB at reference level
<b>Display Scale Fidelity</b> Log Incremental Accuracy  Log Maximum Cumulative  Linear Accuracy	±0.2 dB/2 dB, 0 to -70 dB from reference level  ±0.75 dB, 0 to -60 dB from reference level ±1.0 dB, 0 to -70 dB from reference level  ±3% of reference level
* Frequency Reference Error = (aging rate × period of time since adjustment + initial achievable accuracy + temperature stability) See Table 1-2.	

**Table 1-1. HP 8591A Specifications (5 of 5)**

<b>TRACKING GENERATOR SPECIFICATIONS</b>	
All specifications apply over 0°C to +55°C. The spectrum-analyzer/tracking-generator combination will meet its specifications after 2 hours of storage at a constant temperature within the operating temperature range, 30 minutes after the spectrum-analyzer/tracking-generator is turned on and after CAL FREQ, CAL AMP TD, and CAL TRK GEN have been run.	
<b>Warm-up</b>	30 minutes
<b>Output Frequency</b> Range, 50Ω, Option 010 75Ω, Option 011	100 kHz to 1.8 GHz 1 MHz to 1.8 GHz
<b>Output Power Level</b> Range, 50Ω, Option 010 75Ω, Option 011 Resolution Absolute Accuracy  Vernier Range Accuracy  Output Attenuator Range Switching Accuracy (at 30 MHz)	0 to -70 dBm +42.8 to -27.2 dBmV 0.1 dB ±1.0 dB (at 300 MHz, -20 dBm, and coupled source attenuator) (Option 011: use +28.8 dBmV instead of -20 dBm)  10 dB* ±0.75 dB over 10 dB range (referred to -20 dBm for coupled source attenuator setting)* (Option 011: referred to +28.8 dBmV instead of -20 dBm)  0 to 60 dB in 10 dB steps ±0.8 dB or 2.5% of attenuator setting, whichever is greatest, for maximum of 1.5 dB (referred to 10 dB source attenuator setting)*
<b>Output Power Sweep</b> Range, 50Ω, Option 010 Range, 75Ω, Option 011 Resolution Accuracy (zero span)	(-15 dBm to 0 dBm) - (Source Attenuator setting) (+27.8 to 42.8 dBmV) - (Source Attenuator setting) 0.1 dB <1.5 dB peak-to-peak
<b>Output Flatness</b>	±1.75 dB (referred to 300 MHz, 10 dB attenuator)
<b>Spurious Outputs</b> 50Ω, Option 010 75Ω, Option 011 Harmonic Spurs Non-Harmonic Spurs	(0 dBm output, 100 kHz to 1.8 GHz) (+42.8 dBmV output, 1 MHz to 1.8 GHz) <-25 dBc <-30 dBc
<b>Dynamic Range</b> Tracking Generator Feedthrough, 50Ω, Option 010 Tracking Generator Feedthrough, 75Ω, Option 011	<-106 dBm <-57.24 dBmV
* See Table 1-2, "Tracking Generator Output Accuracy."	

## Characteristics for the HP 8591A

**Table 1-2. HP 8591A Characteristics (1 of 8)**

<p>Note: These are not specifications. Characteristics provide useful, but nonwarranted, information about instrument performance.</p>	
<p><b>FREQUENCY CHARACTERISTICS</b></p>	
<p><b>Frequency Reference</b> Initial Achievable Accuracy</p>	<p><math>\pm 0.5 \times 10^{-6}</math></p>
<p><b>Precision Frequency Reference (Option 004)</b> Aging  Warm-up  Initial Achievable Accuracy</p>	<p><math>5 \times 10^{-10}</math>/day, 7 day average after being powered on for 7 days.  <math>1 \times 10^{-8}</math> after 30 minutes on.  <math>\pm 2.2 \times 10^{-8}</math>, after being powered on for 24 hours.</p>
<p><b>Resolution Bandwidth (-3 dB)</b> Range   Shape</p>	<p>1 kHz to 3 MHz, selectable in 1, 3 and 10 increments, accuracy <math>\pm 20\%</math> and 5 MHz. Resolution bandwidths may be selected manually, or coupled to frequency span.  Synchronously tuned 4 poles. Approximately Gaussian shape.</p>
<p><b>Video Bandwidth (-3 dB)</b> Range   Shape</p>	<p>30 Hz to 1 MHz, selectable in 1, 3, 10 increments, accuracy <math>\pm 30\%</math> and 3 MHz. Video bandwidths may be selected manually, or coupled to resolution bandwidth and frequency span.  Post detection, single pole low-pass filter used to average displayed noise.</p>

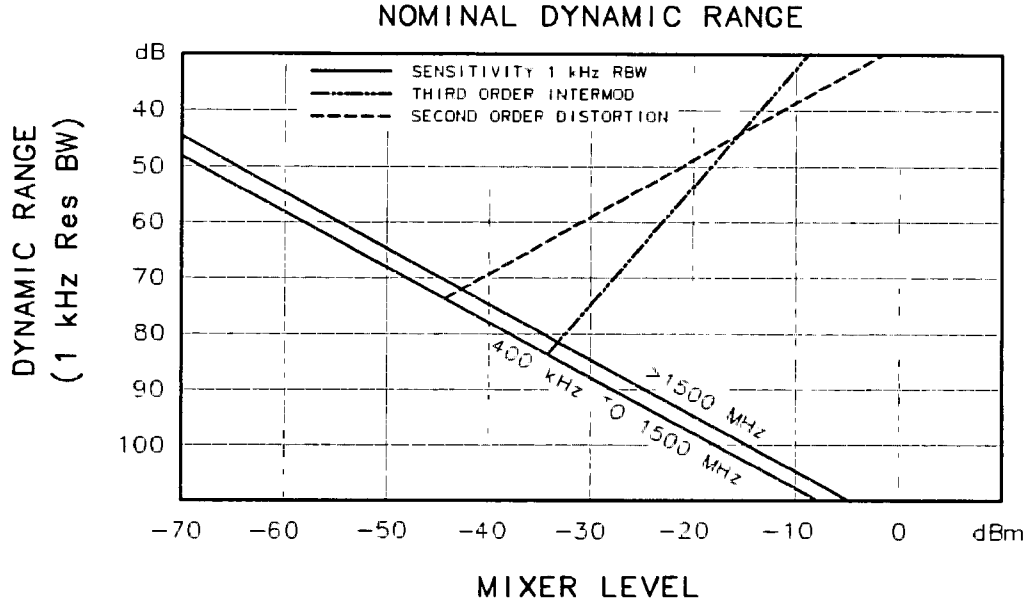

Table 1-2. HP 8591A Characteristics (2 of 8)

AMPLITUDE CHARACTERISTICS	
<b>Absolute Amplitude Calibration Uncertainty*</b>	±0.25 dB
<b>Log Scale Switching Uncertainty</b>	Negligible error.
<b>FM Demod/TV Sync Trigger (Option 102)</b> Demod Tune Listen	Internal speaker, rear panel earphone jack and front panel volume control. Adjustable squelch control mutes the audio signal to the speaker/earphone jack based on the level of the demodulated signal above 22 kHz. An uncalibrated demodulated signal is available on the AUX VIDEO OUT connector at the rear panel.
TV Trigger (Options 101 and 102)	Triggers sweep of the analyzer after the sync pulse of a selected line of a TV video field.
Carrier Level for Trigger	Top 60% of Linear Display.
Compatible Formats	NTSC, PAL, SECAM
Field Selection	Even, Odd, Non-interlaced.
Trigger Polarity	Positive, Negative
Line Selection	10 to 1021.
<b>Input Attenuator Uncertainty†</b> Attenuator Setting	
0 dB	±0.5 dB
10 dB	Ref
20 dB	±0.5 dB
30 dB	±0.6 dB
40 dB	±0.8 dB
50 dB	±1.0 dB
60 dB	±1.2 dB
<b>Input Attenuator Repeatability</b>	
300 MHz	±0.03 dB
1.8 GHz	±1.0 dB
<b>RF Input SWR</b> 9 kHz to 1.8 GHz	(Attenuator Setting 10 to 60 dB) 1.35:1
* Error in the CAL AMPTD routine. Absolute amplitude reference settings. 300 MHz Center Frequency; 10 dB Input Attenuator; -20 dBm Reference Level, 3 kHz Resolution Bandwidth; Linear Scale	
† Referred to 10 dB input attenuator setting from 9 kHz to 1.8 GHz; See Table 1-1, Frequency Response Specification.	

Table 1-2. HP 8591A Characteristics (3 of 8)

**DYNAMIC RANGE**



**HP 8591A Dynamic Range**

<b>FRONT PANEL INPUT / OUTPUT</b>	
<b>INPUT 50Ω</b> Connector Impedance	Type N female 50Ω nominal
<b>INPUT 75Ω (Option 001)</b> Connector Impedance	BNC female 75Ω nominal
<b>PROBE POWER*</b> Voltage/Current	+15 V dc, ±7% at 150 mA max. -12.6 V dc ±10% at 150 mA max.
* Total current drawn from the +15 V dc on the PROBE POWER and the AUX INTERFACE cannot exceed 150 mA. Total current drawn from the -12.6 V dc on the PROBE POWER and the -15 V dc on the AUX INTERFACE cannot exceed 150 mA.	

Table 1-2. HP 8591A Characteristics (4 of 8)

REAR-PANEL INPUTS / OUTPUTS	
<b>10 MHz REF OUTPUT</b>	
Connector	BNC female
Impedance	50Ω
Output Amplitude	>0 dBm
<b>EXT REF IN</b>	
Connector	BNC female
	Note: Analyzer noise sideband and spurious response performance may be affected by the quality of the external reference used.
Input Amplitude Range	-2 to +10 dBm
Frequency	10 MHz
<b>AUX IF OUTPUT</b>	
Frequency	21.4 MHz
Amplitude Range	-10 to -60 dBm
Impedance	50Ω nominal
<b>AUX VIDEO OUTPUT</b>	
Connector	BNC female
Amplitude Range	0 to 1 volt (uncorrected)
<b>EARPHONE (Option 102)</b>	
Connector	1/8 inch monaural jack.
<b>EXT KEYBOARD (Option 021/023)</b>	
	Interface compatible with HP part number C1405 Option ABA and most IBM/AT non-auto switching keyboards.
<b>EXT TRIG INPUT</b>	
Connector	BNC female.
Trigger Level	Positive edge initiates sweep in EXT TRIG mode (TTL).
<b>HI-SWEEP IN/OUT</b>	
Connector	BNC female.
Output	TTL high=sweep, low=retrace.
Input	Open collector, low stops sweep.
<b>MONITOR OUTPUT</b>	
Connector	BNC female.
Format	NTSC Video, 19.2 kHz horizontal rate.
<b>REMOTE INTERFACE</b>	
Option 021, HPIB	
HPIB Codes	SH1, AH1, T6, SR1, RL1, PP0, DC1, C1, C2, C3 and C28.
Option 023, RS-232	
<b>SWEEP OUTPUT</b>	
Connector	BNC female.
Amplitude	0 to +10 volt ramp.
<b>TV TRIG OUT (Options 101 and 102)</b>	
Connector	BNC female.
Amplitude	Negative edge corresponds to start of the selected TV line after sync pulse (TTL)

**Table 1-2. HP 8591A Characteristics (5 of 8)**

<b>WEIGHT</b>	
<b>Net</b> HP 8591A	14.5 kg (32 lb)
<b>Shipping</b> HP 8591A	17.3 kg (38 lb)
<b>DIMENSIONS</b>	
A = 8 in (200 mm)	
B = 7.25 in (184 mm)	
C = 14.69 in (373 mm)	
D = 13.25 in (337 mm)	
E = 18.12 in (460.5 mm)	

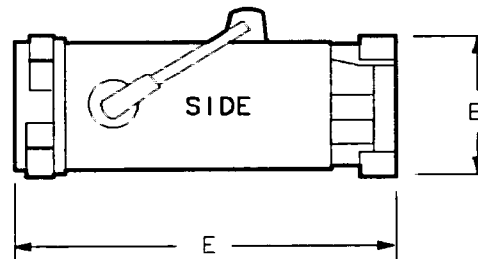
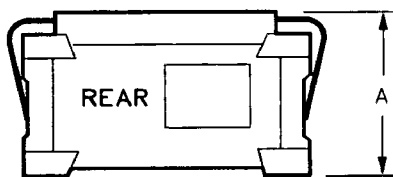
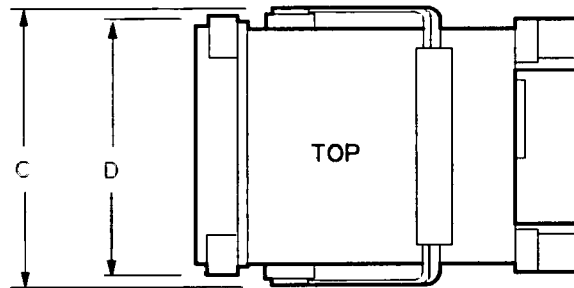

**HP 8591A Dimensions**

**Table 1-2. HP 8591A Characteristics (6 of 8)**

AUX INTERFACE				
Connector Type : 9 Pin Subminiature "D"				
Connector Pinout				
Pin #	Function	Current	"Logic" Mode	"Serial Bit" Mode
1	Control A	—	TTL Output Hi/Lo	TTL Output Hi/Lo
2	Control B	—	TTL Output Hi/Lo	TTL Output Hi/Lo
3	Control C	—	TTL Output Hi/Lo	Strobe
4	Control D	—	TTL Output Hi/Lo	Serial Data
5	Control I	—	TTL Input Hi/Lo	TTL Input Hi/Lo
6	Gnd	—	Gnd	Gnd
7†	-15 V dc ±7%	150 mA	—	—
8*	+5 V dc ±5%	150 mA	—	—
9†	+15 V dc ±5%	150 mA	—	—
TRACKING GENERATOR INPUTS AND OUTPUTS				
<b>RF Output</b>				
Impedance Connector				
Option 010		50Ω, Type N female		
Option 011		75Ω, BNC female		
<b>Maximum Reverse Level</b>				
Option 010		+20 dBm (0.1 W), 25 V		
Option 011		+69 dBmV (0.1 W), 100 V		
<b>External ALC Input</b>				
Impedance		1 Megohm		
Polarity		Positive or Negative		
Range		-66 dBV to +6 dBV		
Connector		BNC		
* Exceeding the +5 V current limits may result in loss of factory correction constants.				
† Total current drawn from the +15 V dc on the PROBE POWER and the AUX INTERFACE cannot exceed 150 mA. Total current drawn from the -12.6 V dc on the PROBE POWER and the -15 V dc on the AUX INTERFACE cannot exceed 150 mA				

**Table 1-2. HP 8591A Characteristics (7 of 8)**

<b>TRACKING GENERATOR CHARACTERISTICS</b>	
<b>Output Tracking</b> Drift (usable in 10 kHz bandwidth after 30 minute warmup)	1 kHz/5 minutes
<b>Spurious Outputs</b> Option 010: 0 dBm output, >1.8 GHz to 4.0 GHz Option 011: +42.8 dBmV 75Ω, >1.8 GHz to 4.0 GHz Harmonic Non-Harmonic 2121.4 MHz Feedthrough	< -20 dBc < -40 dBc for 0 dBm TG Output Option 010: < -45 dBc; Option 011: +42.8 dBmV Output
<b>RF Power-Off Residuals</b> Option 010: 100 kHz to 1.8 GHz Option 011: 1 MHz to 1.8 GHz	< -115 dBm < -66.2 dBmV
<b>Output Attenuator</b> Repeatability	±0.2 dB
<b>Output VSWR</b> 0 dB Attenuator 10 dB Attenuator	<2.5:1 <1.6:1
<b>Dynamic Range</b> (difference between maximum power out and tracking generator feedthrough) Option 010, 100 kHz to 1.8 GHz Option 011, 1 MHz to 1.8 GHz	>106 dB >100 dB

**Table 1-2. HP 8591A Characteristics (8 of 8)**

<b>TRACKING GENERATOR OUTPUT ACCURACY, Option 010</b> (after CAL TRK GEN in auto-coupled mode)					
<b>TG Output Power Level</b>	<b>Attenuator Setting</b>	<b>Relative Accuracy (at 300 MHz referred to -20 dBm)</b>	<b>Absolute Accuracy (at 300 MHz)</b>	<b>Relative Accuracy (referred to -20 dBm) (+0.2 dB/GHz)*</b>	<b>Absolute Accuracy (+0.2 dB/GHz)*</b>
0 to -10.9 dBm	0 dB	±1.25 dB	±2.25 dB	±2.75 dB	±3.75 dB
-11 to -20.9 dBm	10 dB	±0.75 dB	±1.75 dB	±2.25 dB	±3.25 dB
-20 dBm	10 dB	0 dB Reference	±1.0 dB	±1.50 dB	±2.50 dB
-21 to -30.9 dBm	20 dB	±1.25 dB	±2.25 dB	±2.75 dB	±3.75 dB
-31 to -40.9 dBm	30 dB	±1.35 dB	±2.35 dB	±2.85 dB	±3.85 dB
-41 to -50.9 dBm	40 dB	±1.55 dB	±2.55 dB	±3.05 dB	±4.05 dB
-51 to -60.9 dBm	50 dB	±1.75 dB	±2.75 dB	±3.25 dB	±4.25 dB
-61 to -70 dBm	60 dB	±1.95 dB	±2.95 dB	±3.45 dB	±4.45 dB
<b>TRACKING GENERATOR OUTPUT ACCURACY, Option 011</b> (after CAL TRK GEN in auto-coupled mode)					
<b>TG Output Power Level</b>	<b>Attenuator Setting</b>	<b>Relative Accuracy (at 300 MHz referred to +28.8 dBmV)</b>	<b>Absolute Accuracy (at 300 MHz)</b>	<b>Relative Accuracy (referred to +28.8 dBmV) (+0.2 dB/GHz)*</b>	<b>Absolute Accuracy (+0.2 dB/GHz)*</b>
+42.76 to +31.77 dBmV	0 dB	±1.25 dB	±2.25 dB	±2.75 dB	±3.75 dB
+31.76 to +21.77 dBmV	10 dB	±0.75 dB	±1.75 dB	±2.25 dB	±3.25 dB
-28.76 dBmV	10 dB	0 dB Reference	±1.0 dB	±1.50 dB	±2.50 dB
+21.76 to +11.77 dBmV	20 dB	±1.25 dB	±2.25 dB	±2.75 dB	±3.75 dB
+11.76 to +1.77 dBmV	30 dB	±1.35 dB	±2.35 dB	±2.85 dB	±3.85 dB
+1.76 to -8.23 dBmV	40 dB	±1.55 dB	±2.55 dB	±3.05 dB	±4.05 dB
-8.24 to -18.23 dBmV	50 dB	±1.75 dB	±2.75 dB	±3.25 dB	±4.25 dB
-18.24 to -27.23 dBmV	60 dB	±1.95 dB	±2.95 dB	±3.45 dB	±4.45 dB
* Add 0.2 dB/GHz of tuned frequency to the value in this column for complete accuracy specification relative to frequency.					

# Specifications for the HP 8593A

Table 1-3. HP 8593A Specifications (1 of 5)

<b>GENERAL SPECIFICATIONS</b>	
All specifications apply over 0°C to +55°C. The analyzer will meet its specifications after 2 hours of storage at a constant temperature, within the operating temperature range, 30 minutes after the analyzer is turned on and after CAL FREQ, CAL AMPTD and CAL YTF have been run.	
<b>Temperature Range</b> Operating Storage	0°C to +55°C -40°C to +75°C
<b>EMI Compatibility</b>	Conducted and radiated interference CISPR Pub. 11 and Messemppfaenger Postverfuegung 526/527/79
<b>Audible Noise</b>	<37.5 dBA pressure and <5.0 Bels power (ISODP7779)
<b>Power Requirements</b> ON (LINE 1)  Standby (LINE 0)	86 to 127, or 195 to 250 V rms, 47 to 66 Hz. 103 to 126 V rms, 400 Hz ± 10% Power consumption <300 VA Power consumption <7 watts
<b>FREQUENCY SPECIFICATIONS</b>	
<b>Frequency Range</b>  <b>Band</b> <b>LO Harmonic (N)</b>	9 kHz to 22 GHz <i>(Option 026)</i> 9 kHz to 26.5 GHz
0            1-	9 kHz to 2.9 GHz
1            1-	2.75 GHz to 6.4 GHz
2            2-	6.0 GHz to 12.8 GHz
3            3-	12.4 GHz to 19.4 GHz
4            4-	19.1 GHz to 22 GHz
4            4- <i>(Option 026)</i>	19.1 GHz to 26.5 GHz
<b>Frequency Reference</b> Aging  Settability Temperature Stability	±1 × 10 <sup>-7</sup> /day ±2 × 10 <sup>-6</sup> /year  ±0.5 × 10 <sup>-6</sup> ±5 × 10 <sup>-6</sup>
<b>Precision Freq. Reference</b> <i>(Option 004)</i> Aging Settability Temperature Stability	±1 × 10 <sup>-7</sup> /year ±1 × 10 <sup>-8</sup> ±1 × 10 <sup>-8</sup>



Table 1-3. HP 8593A Specifications (2 of 5)

FREQUENCY SPECIFICATIONS (Continued)	
<b>Frequency Accuracy</b> Readout Accuracy (Start, Stop, Center, Marker)  <b>Marker Count Accuracy</b> Frequency Span $\leq 10$ MHz  Frequency Span $> 10$ MHz  Counter Resolution	$\pm(\text{frequency readout} \times \text{frequency reference error}^* + 3\% \text{ of span} + 20\% \text{ of RBW} + 1.5 \text{ kHz})$  (Signal-to-Noise ratio $\geq 25$ dB, RBW/span $\geq 0.01$ ) $\pm(\text{marker frequency} \times \text{frequency reference error}^* + \text{counter resolution} + 100 \text{ Hz})$  $\pm(\text{marker frequency} \times \text{frequency reference error}^* + \text{counter resolution} + 1 \text{ kHz})$ Selectable from 10 Hz to 100 kHz
<b>Frequency Span</b> Range  (Option 026)  Resolution  Accuracy	0 Hz (zero span), $(10 \times N)$ kHz to 19.25 GHz 0 Hz, (zero span), $(10 \times N)$ kHz to 23.75 GHz  4 digits  $\pm 2\%$ of span, span $\leq 10$ MHz $\pm 3\%$ of span, span $> 10$ MHz and single band spans
<b>Frequency Sweep Time</b> Range Span = 0 Hz Span = 0 Hz Span $> 10$ kHz  Accuracy 20 ms to 100 s 20 $\mu$ s to $< 20$ ms Sweep Trigger  (Option 101)  (Option 101)	20 ms to 100 s 20 $\mu$ s to 100 s 20 ms to 100 s  $\pm 3\%$ $\pm 2\%$ Free run, Single, Line, Video, External
<b>Stability</b> Noise Sidebands  Residual FM  System Related Sidebands	$\leq -95 \text{ dBc/Hz} + 20 \text{ Log } N \dagger$ at $> 30$ kHz offset from CW signal (1 kHz RBW, 30 Hz VBW, and sample detector)  $< (400 \times N)$ Hz pk-pk in 100 ms (1 kHz RBW, 1 kHz VBW)  $< -65 \text{ dBc} + 20 \text{ Log } N \dagger$ at $> 30$ kHz offset from CW signal
<b>Comb Generator</b> Frequency Accuracy	100 MHz fundamental frequency $\pm 0.007\%$
* Frequency Reference Error = (Aging rate $\times$ period of time since adjustment + initial achievable accuracy + temperature stability). See Table 1-4. † N = LO Harmonic.	

Table 1-3. HP 8593A Specifications (3 of 5)

AMPLITUDE SPECIFICATIONS	
<b>Amplitude Range</b>	-114 dBm to +30 dBm
<b>Maximum Safe Input Level</b> Average Continuous Power	+30 dBm (1 watt, 7.1 V rms), Input Atten $\geq 10$ dB in bands 1 through 4
Peak Pulse Power	+50 dBm (100 watts) for $< 10 \mu\text{s}$ pulse width and $< 1\%$ duty cycle, Input Atten $\geq 30$ dB
DC	0 V dc
<b>Gain Compression</b> >10 MHz	$\leq 0.5$ dB (total power at input mixer* = -10 dBm)
<b>Displayed Average Noise Level</b>	(Input terminated, 0 dB attenuation, 1 kHz RBW, 30 Hz VBW, sample detector)
400 kHz to 2.9 GHz	$\leq -112$ dBm
2.75 GHz to 6.4 GHz	$\leq -114$ dBm
6.0 GHz to 12.8 GHz	$\leq -102$ dBm
12.4 GHz to 19.4 GHz	$\leq -98$ dBm
19.1 GHz to 22 GHz	$\leq -92$ dBm
19.1 GHz to 26.5 GHz ( <i>Option 026</i> )	$\leq -87$ dBm
<b>Spurious Responses</b>	
Second Harmonic Distortion 10 MHz to 2.9 GHz > 2.75 GHz	$< -70$ dBc for -40 dBm tone at input mixer* $< -100$ dBc for -10 dBm tone at input mixer* (or below displayed average noise level)
Third Order Intermodulation Distortion >10 MHz	$< -70$ dBc for two -30 dBm tones at input mixer* and $> 50$ kHz separation
Other Input Related Spurious	$< -70$ dBc for applied frequencies $\leq 18$ GHz $< -60$ dBc for applied frequencies $\leq 22$ GHz
<b>Residual Responses</b>	(Input terminated and 0 dB attenuation)
150 kHz to 2.9 GHz (Band 0)	$< -90$ dBm
2.75 GHz to 6.4 GHz (Band 1)	$< -90$ dBm
<b>Display Range</b>	
Log Scale	0 to -70 dB from reference level is calibrated; 1 to 20 dB/division in 1 dB steps; 8 divisions displayed
Linear Scale	8 divisions
Scale Units	dBm, dBmV, dB $\mu$ V, volts and watts
Marker Readout Resolution	0.05 dB for log scale 0.05% of reference level for linear scale
Fast Sweep Times for Zero Span 20 $\mu\text{s}$ to 20 ms ( <i>Option 101</i> )	0.7% of reference level for linear scale
* Mixer Power Level (dBm) = Input Power (dBm) - Input Attenuator (dB).	

**Table 1-3. HP 8593A Specifications (4 of 5)**

<b>AMPLITUDE SPECIFICATIONS (Continued)</b>																													
<b>Reference Level</b> Range Resolution  Accuracy 0 dBm to -59.9 dBm -60 dBm to -114 dBm	-114 dBm to +30 dBm 0.01 dB for log scale 0.12% of reference level for linear scale  (Referred to -20 dBm Reference Level) ±(0.5 dB + Input Attenuator Accuracy at 50 MHz) ±(1.25 dB + Input Attenuator Accuracy at 50 MHz)																												
<b>Frequency Response</b> Absolute* 9 kHz to 2.9 GHz† 2.75 GHz to 6.4 GHz 6.0 GHz to 12.8 GHz 12.4 GHz to 19.4 GHz 19.1 GHz to 22 GHz 19.1 GHz to 26.5 GHz ( <i>Option 026</i> )  Relative Flatness‡ 9 kHz to 2.9 GHz† 2.75 GHz to 6.4 GHz 6.0 GHz to 12.8 GHz 12.4 GHz to 19.4 GHz 19.1 GHz to 22 GHz 19.1 GHz to 26.5 GHz ( <i>Option 026</i> )	(10 dB input attenuation) <table style="width: 100%; border-collapse: collapse;"> <thead> <tr> <th style="text-align: left;">Presel. Peaked</th> <th style="text-align: left;">Unpeaked</th> </tr> </thead> <tbody> <tr> <td>N/A</td> <td>±1.5 dB</td> </tr> <tr> <td>±2.0 dB</td> <td>±3.0 dB</td> </tr> <tr> <td>±2.5 dB</td> <td>±3.0 dB</td> </tr> <tr> <td>±3.0 dB</td> <td>±4.0 dB</td> </tr> <tr> <td>±3.0 dB</td> <td>±4.0 dB</td> </tr> <tr> <td>±5.0 dB</td> <td>±5.0 dB</td> </tr> <tr> <td colspan="2"> </td> </tr> <tr> <td>N/A</td> <td>±1.0 dB</td> </tr> <tr> <td>±1.5 dB</td> <td>N/A</td> </tr> <tr> <td>±2.0 dB</td> <td>N/A</td> </tr> <tr> <td>±2.0 dB</td> <td>N/A</td> </tr> <tr> <td>±2.0 dB</td> <td>N/A</td> </tr> <tr> <td>±2.0 dB</td> <td>N/A</td> </tr> </tbody> </table>	Presel. Peaked	Unpeaked	N/A	±1.5 dB	±2.0 dB	±3.0 dB	±2.5 dB	±3.0 dB	±3.0 dB	±4.0 dB	±3.0 dB	±4.0 dB	±5.0 dB	±5.0 dB			N/A	±1.0 dB	±1.5 dB	N/A	±2.0 dB	N/A	±2.0 dB	N/A	±2.0 dB	N/A	±2.0 dB	N/A
Presel. Peaked	Unpeaked																												
N/A	±1.5 dB																												
±2.0 dB	±3.0 dB																												
±2.5 dB	±3.0 dB																												
±3.0 dB	±4.0 dB																												
±3.0 dB	±4.0 dB																												
±5.0 dB	±5.0 dB																												
N/A	±1.0 dB																												
±1.5 dB	N/A																												
±2.0 dB	N/A																												
±2.0 dB	N/A																												
±2.0 dB	N/A																												
±2.0 dB	N/A																												
<b>Calibrator Output</b> Frequency Amplitude	300 MHz ±(300 MHz × frequency reference error§) -20 dBm ±0.4 dB																												
<b>Input Attenuator</b> Range Accuracy 0 to 60 dB 70 dB	0 to 70 dB, in 10 dB steps  ±0.5 dB at 50 MHz, referred to 10 dB attenuation ±1.2 dB at 50 MHz, referred to 10 dB attenuation																												
<b>Resolution Bandwidth Switching Uncertainty</b> 3 kHz to 3 MHz RBW 1 kHz	(Referred to 3 kHz RBW)  ±0.4 dB ±0.5 dB																												
* Referred to 300 MHz CAL OUT. † Preselector is not used in Band 0 (9 kHz to 2.9 GHz). ‡ Referred to midpoint between highest and lowest frequency response deviations. § Frequency Reference Error = (Aging rate × period of time since adjustment + initial achievable accuracy + temperature stability) See Table 1-4.																													

**Table 1-3. HP 8593A Specifications (5 of 5)**

<b>AMPLITUDE SPECIFICATIONS (Continued)</b>	
<b>Log to Linear Switching</b>	±0.25 dB at reference level
<b>Display Scale Fidelity</b>	
Log Incremental Accuracy	±0.2 dB/2 dB, 0 to -70 dB from reference level
Log Maximum Cumulative	±0.75 dB, 0 to -60 dB from reference level ±1.0 dB, 0 to -70 dB from reference level
Linear Accuracy	±3% of reference level

**Characteristics for the HP 8593A**

**Table 1-4. HP 8593A Characteristics (1 of 6)**

<p>Note: These are not specifications. Characteristics provide useful, but nonwarranted, information about instrument performance.</p>	
<b>FREQUENCY CHARACTERISTICS</b>	
<b>Frequency Reference</b>	
Initial Achievable Accuracy	±0.5 × 10 <sup>-6</sup>
<b>Precision Frequency Reference (Option 004)</b>	
Aging	5 × 10 <sup>-10</sup> /day, 7 day average after being powered on for 7 days.
Warm-up	1 × 10 <sup>-8</sup> after 30 minutes on.
Initial Achievable Accuracy	±2.2 × 10 <sup>-8</sup> , after being powered on for 24 hours.
<b>Resolution Bandwidth (-3 dB)</b>	
Range	1 kHz to 3 MHz, selectable in 1, 3 and 10 increments, accuracy ±20% and 5 MHz. Resolution bandwidths may be selected manually, or coupled to frequency span.
Shape	Synchronously tuned 4 poles. Approximately Gaussian shape.
<b>Video Bandwidth (-3 dB)</b>	
Range	30 Hz to 1 MHz, selectable in 1, 3, 10 increments, accuracy ±30% and 3 MHz. Video bandwidths may be selected manually, or coupled to resolution bandwidth and frequency span.
Shape	Post detection, single pole low-pass filter used to average displayed noise.

Table 1-4. HP 8593A Characteristics (2 of 6)

<b>AMPLITUDE CHARACTERISTICS</b>	
<b>Absolute Amplitude Calibration Uncertainty*</b>	±0.25 dB
<b>Log Scale Switching Uncertainty</b>	Negligible error
<b>FM Demod/TV Sync Trigger (Option 102)</b> Demod Tune Listen	Internal speaker, rear panel earphone jack and front panel volume control. Adjustable squelch control mutes the audio signal to the speaker/earphone jack based on the level of the demodulated signal above 22 kHz. An uncalibrated demodulated signal is available on the AUX VIDEO OUT connector at the rear panel.
TV Trigger (Options 101 and 102)	Triggers sweep of the analyzer after the sync pulse of a selected line of a TV video field.
Carrier Level for Trigger	Top 60% of Linear Display.
Compatible Formats	NTSC, PAL, SECAM.
Field Selection	Even, Odd, Noninterlaced.
Trigger Polarity	Positive, Negative.
Line Selection	10 to 1021.
<b>Input Attenuation Uncertainty†</b> Attenuator Setting	9 kHz to 12.4 GHz    12.4 to 19 GHz    19 to 22 GHz
0 dB	±0.75 dB                      ±1.0 dB                      ±1.0 dB
10 dB	Reference
20 dB	±0.75 dB                      ±0.75 dB                      ±1.0 dB
30 dB	±0.75 dB                      ±1.0 dB                      ±1.25 dB
40 dB	±0.75 dB                      ±1.25 dB                      ±2.0 dB
50 dB	±1.0 dB                      ±1.5 dB                      ±2.5 dB
60 dB	±1.5 dB                      ±2.0 dB                      ±3.0 dB
70 dB	±2.0 dB                      ±2.5 dB                      ±3.5 dB
<b>Input Attenuator 10 dB Step Uncertainty</b> Center Frequency	(Attenuator Setting 10 to 70 dB)
9 kHz to 19 GHz	±1.0 dB/10 dB
19 GHz to 22 GHz	±1.5 dB/10 dB
<b>Input Attenuator Repeatability</b>	±0.05 dB
<b>RF Input SWR</b> 300 MHz, at 10 dB atten	1.2:1
9 kHz to 12.4 GHz, at 10 to 70 dB atten	1.5:1
12.4 GHz to 19 GHz, at 10 to 70 dB atten	2.0:1
19 GHz to 22 GHz, at 10 to 70 dB atten	2.0:1
* Error in the CAL AMPTD routine. Absolute amplitude reference settings: 300 MHz Center Frequency; 10 dB Input Attenuator; -20 dBm Reference Level; 3 kHz Resolution Bandwidth; Linear Scale.	
† Referred to 10 dB input attenuator setting; See Table 1-3, Frequency Response Specification.	

Table 1-4. HP 8593A Characteristics (3 of 6)

**DYNAMIC RANGE**

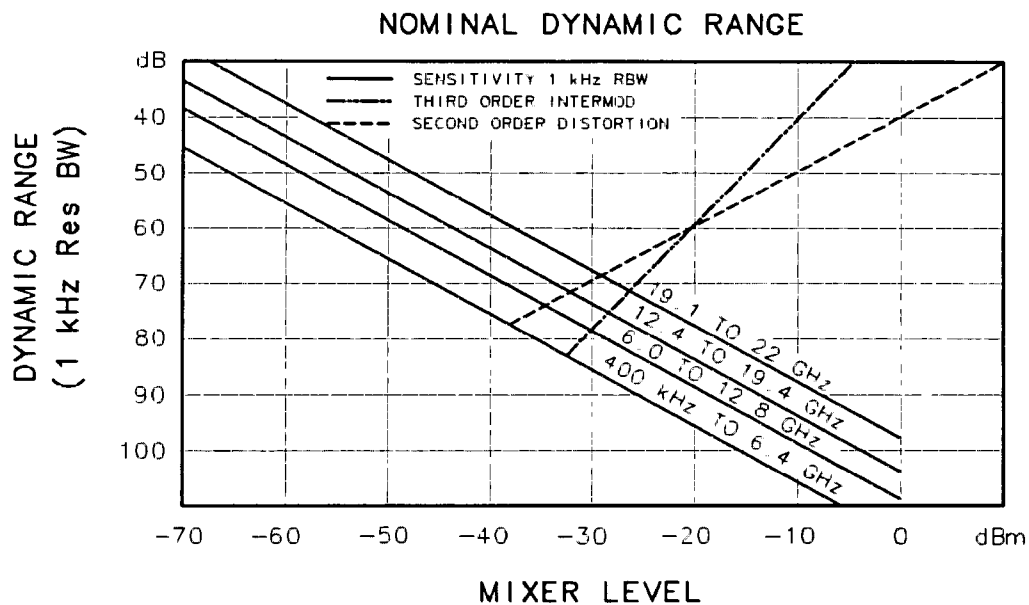

**FRONT PANEL INPUT / OUTPUT**

**INPUT 50Ω**

Connector  
Impedance

Type N female  
50Ω nominal

**INPUT 50Ω (Option 026)**

Connector  
Impedance

APC 3.5 male  
50Ω nominal

**PROBE POWER\***

Voltage/Current

+15 V dc, ±7% at 150 mA max  
-12.6 V dc ±10% at 150 mA max

\* Total current drawn from the +15 V dc on the PROBE POWER and the AUX INTERFACE cannot exceed 150 mA. Total current drawn from the -12.6 V dc on the PROBE POWER and the -15 V dc on the AUX INTERFACE cannot exceed 150 mA.

Table 1-4. HP 8593A Characteristics (4 of 6)

REAR-PANEL INPUTS / OUTPUTS	
<b>10 MHz REF OUTPUT</b>	
Connector	BNC female
Impedance	50Ω
Output Amplitude	>0 dBm
<b>EXT REF IN</b>	
Connector	BNC female
	Note: Analyzer noise sideband and spurious response performance may be affected by the quality of the external reference used.
Input Amplitude Range	-2 to +10 dBm
Frequency	10 MHz
<b>AUX IF OUTPUT</b>	
Frequency	21.4 MHz
Amplitude Range	-10 to -60 dBm
Impedance	50Ω nominal
<b>AUX VIDEO OUTPUT</b>	
Connector	BNC female
Amplitude Range	0 to 1 volt (uncorrected)
<b>EARPHONE (Option 102)</b>	
Connector	1/8 inch monaural jack
<b>EXT KEYBOARD (Option 021/023)</b>	
	Interface compatible with HP part number C1405 Option ABA and most IBM/AT non-auto switching keyboards.
<b>EXT TRIG INPUT</b>	
Connector	BNC female
Trigger Level	Positive edge initiates sweep in EXT TRIG mode (TTL).
<b>HI-SWEEP IN/OUT</b>	
Connector	BNC female
Output	TTL high=sweep, low=retrace
Input	Open collector, low stops sweep.
<b>MONITOR OUTPUT</b>	
Connector	BNC female
Format	NTSC Video, 19.2 kHz horizontal rate.
<b>REMOTE INTERFACE</b>	
Option 021, HPIB	
HPIB Codes	SH1, AH1, T6, SR1, RL1, PP0, DC1, C1, C2, C3 and C28
Option 023, RS-232	
<b>SWEEP OUTPUT</b>	
Connector	BNC female
Amplitude	0 to +10 volt ramp
<b>TV TRIG OUT (Options 101 and 102)</b>	
Connector	BNC female
Amplitude	Negative edge corresponds to start of the selected TV line after sync pulse (TTL).

**Table 1-4. HP 8593A Characteristics (5 of 6)**

<b>WEIGHT</b>	
<b>Net</b> HP 8593A	16.4 kg (36 lb)
<b>Shipping</b> HP 8593A	19.1 kg (42 lb)
<b>DIMENSIONS</b>	
A = 8 in (200 mm) B = 7.25 in (184 mm) C = 14.69 in (373 mm) D = 13.25 in (337 mm) E = 18 1/2 in (460.5 mm)	

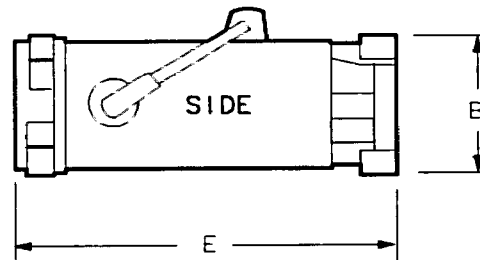
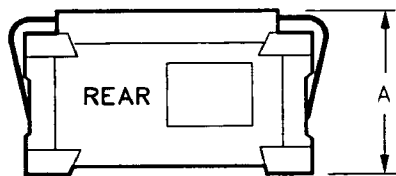
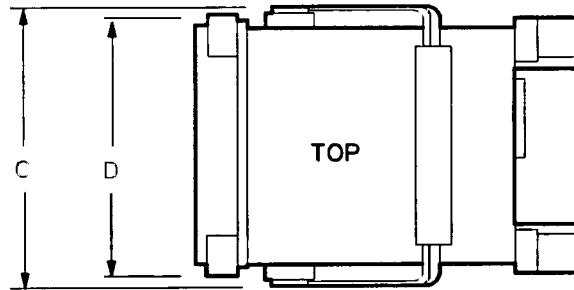

**HP 8593A Dimensions**



Table 1-4. HP 8593A Characteristics (6 of 6)

AUX INTERFACE				
Connector Type : 9 Pin Subminiature "D"				
Connector Pinout				
Pin #	Function	Current	"Logic" Mode	"Serial Bit" Mode
1	Control A	—	TTL Output Hi/Lo	TTL Output Hi/Lo
2	Control B	—	TTL Output Hi/Lo	TTL Output Hi/Lo
3	Control C	—	TTL Output Hi/Lo	Strobe
4	Control D	—	TTL Output Hi/Lo	Serial Data
5	Control I	—	TTL Input Hi/Lo	TTL Input Hi/Lo
6	Gnd	—	Gnd	Gnd
7†	-15 V dc ±7%	150 mA	—	—
8*	+5 V dc ±5%	150 mA	—	—
9†	+15 V dc ±5%	150 mA	—	—

\* Exceeding the +5 V current limits may result in loss of factory correction constants

† Total current drawn from the +15 V dc on the PROBE POWER and the AUX INTERFACE cannot exceed 150 mA. Total current drawn from the -12.6 V dc on the PROBE POWER and the -15 V dc on the AUX INTERFACE cannot exceed 150 mA.

## Electrostatic Discharge

Electrostatic discharge (ESD) can damage or destroy electronic components. All work on electronic assemblies should be performed at a static-safe work station. Figure 1-3 shows an example of a static-safe work station using two types of ESD protection:

- Conductive table-mat and wrist-strap combination.
- Conductive floor-mat and heel-strap combination.

Both types, when used together, provide a significant level of ESD protection. Of the two, only the table-mat and wrist-strap combination provides adequate ESD protection when used alone.

To ensure user safety, the static-safe accessories must provide at least  $1\text{ M}\Omega$  of isolation from ground. Refer to Table 1-5 for information on ordering static-safe accessories.

### Warning



These techniques for a static-safe work station should not be used when working on circuitry with a voltage potential greater than 500 volts.

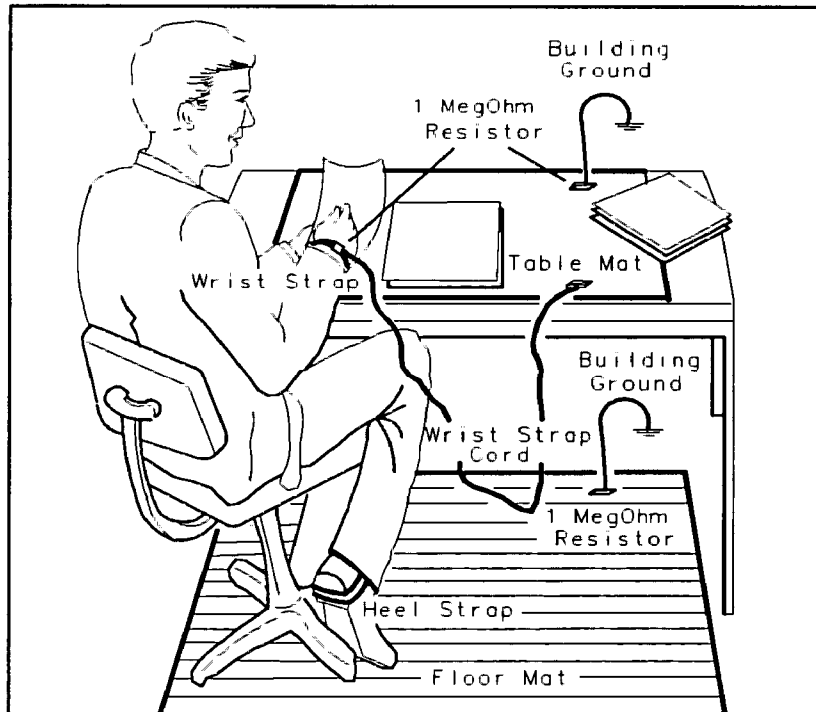

Figure 1-3. Example of a Static-Safe Work Station

## **Reducing Damage Caused by ESD**

The following suggestions may help reduce ESD damage that occurs during testing and servicing operations.

- Before connecting any coaxial cable to an analyzer connector for the first time each day, momentarily ground the center and outer conductors of the cable.
- Personnel should be grounded with a resistor-isolated wrist strap before touching the center pin of any connector and before removing any assembly from the unit.
- Be sure that all instruments are properly earth-grounded to prevent a buildup of static charge.

Table 1-5 lists static-safe accessories that can be obtained from Hewlett-Packard by using the HP part numbers shown.

**Table 1-5. Static-Safe Accessories**

Accessory	Description	HP Part Number
Static-control mat and ground wire	Set includes:  3M static-control mat, 0.6 m × 1.2 m (2 ft × 4 ft)  ground wire, 4.6 m (15 ft) (The wrist strap and wrist-strap cord are <i>not</i> included. They must be ordered separately.)	9300-0797
Wrist-strap cord	1.5 m (5 ft)	9300-0980
Wrist strap	Black, stainless steel with four adjustable links and 7-mm post-type connector (The wrist-strap cord is <i>not</i> included.)	9300-1383
ESD heel strap	Reusable 6 to 12 months	9300-1169
Hard-surface static-control mat*	Large, black, 1.2 m × 1.5 m (4 ft × 5 ft)  Small, black, 0.9 m × 1.2 m (3 ft × 4 ft)	92175A  92175C
Soft-surface static-control mat*	Brown, 1.2 m × 2.4 m (4 ft × 8 ft)	92175B
Tabletop static-control mat*	58  cm × 76 cm (23 in × 30 in)	92175T
Antistatic carpet*	Small, 1.2 m × 1.8 m (4 ft × 6 ft)  natural color russet color  Large, 1.2 m × 2.4 m (4 ft × 8 ft)  natural color russet color	92176A 92176C  92176B 92176D
* These accessories can be ordered either through a Hewlett-Packard Sales Office or through HP DIRECT Phone Order Service. In the USA, the HP DIRECT phone number is (800) 538-8787. Contact your nearest Hewlett-Packard Sales Office for more information about HP DIRECT availability in other countries.		

**2. Installation and Preparation  
for Use**

## Installation and Preparation for Use

---

### What You'll Find in This Chapter

This chapter describes the process of getting the spectrum analyzer ready to use. The process includes initial inspection, setting up the unit for the selected ac power source, and performing automatic self-calibration routines. Information about insertion of the memory card, replacement of the memory card battery, and replacement of the analyzer battery is also provided.

---

### Getting Ready

#### Initial Inspection

Inspect the shipping container for damage. If the shipping container or cushioning material is damaged, keep it until you have verified that the contents are complete and you have tested the analyzer mechanically and electrically.

The analyzer is packed within a carton as shown in Figure 2-1. Table 2-1 contains the description and part numbers of the packaging materials. Table 2-2 contains the accessories shipped with the analyzer. If the contents are incomplete or if the analyzer does not pass the verification tests (procedures are provided in Chapter 3 and in Chapter 4), notify the nearest Hewlett-Packard office. If the shipping container is damaged or the cushioning material shows signs of stress, also notify the carrier. Keep the shipping materials for the carrier's inspection. The HP office will arrange for repair or replacement without waiting for a claim settlement.

If the shipping materials are in good condition, retain them for possible future use. You may wish to ship the analyzer to another location or to return it to Hewlett-Packard for service. See "How to Return Your Analyzer for Servicing," in Chapter 8.

---

**Note**

Complete instructions for installing your analyzer in an equipment rack are provided in a service note that is included with Options 908 and 909 Rack Mounting Kits.

---

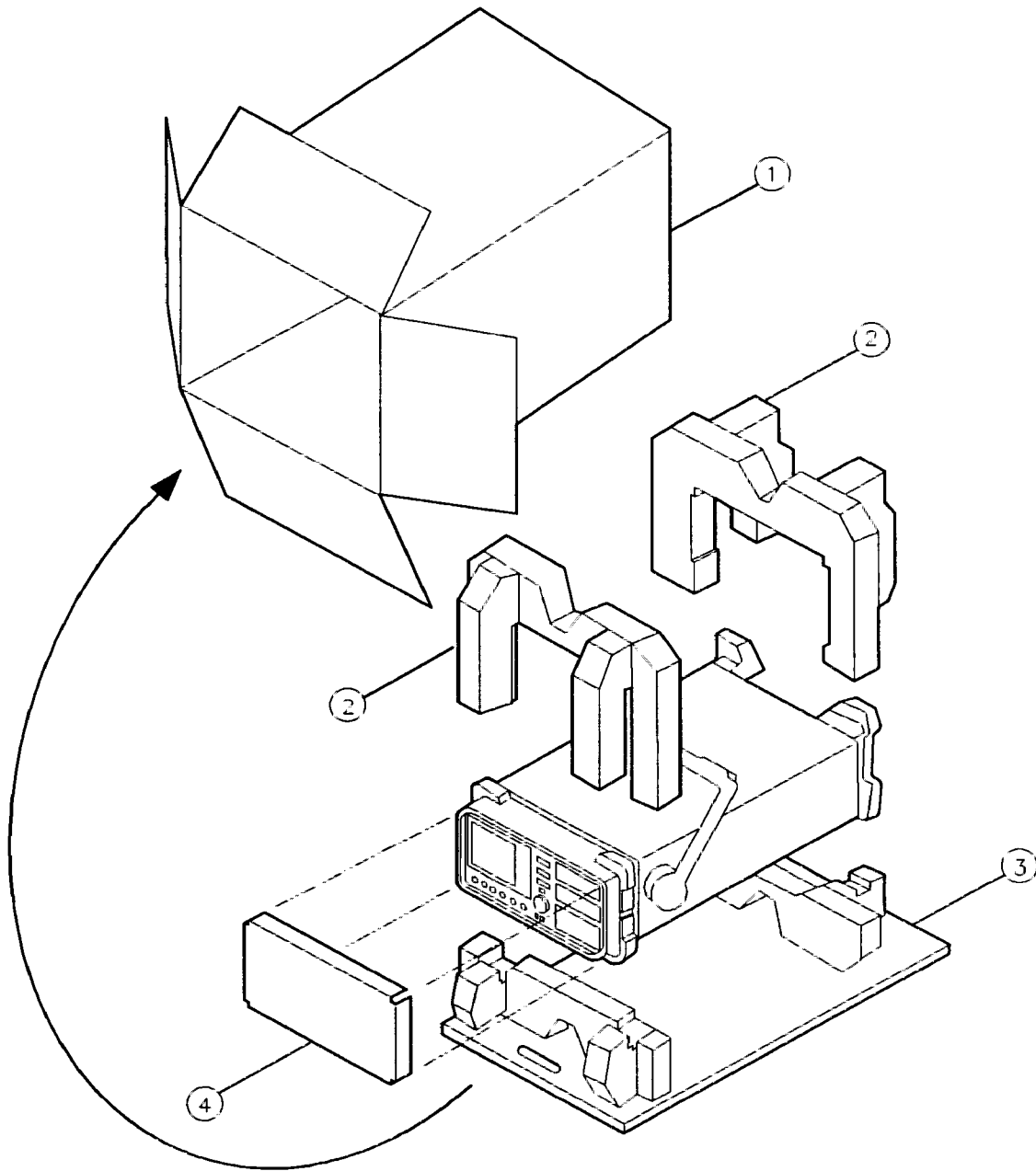

**Figure 2-1. HP 8591A/8593A Packaging**

**Table 2-1. Packaging Materials**

Item	Description	HP Part Number
1	Outer Carton	9211-5636
2	Foam Pad Set	08590-80013
3	Bottom Tray	08590-80014
4	Front Frame Insert	9220-4488

**2-2 Installation and Preparation for Use**

**Table 2-2. Accessories Supplied with the Analyzer (but not Shown)**

Description	HP Part Number	Comments
32 kilobyte Memory Card	HP 0950-1964	Shipped with analyzer.
Memory Card Holder	HP 9222-1545	Shipped with analyzer.
Adapter, Type N (m) to BNC (f)	HP 1250-0780	Not shipped with Option 001 or Option 026. Two adapters are shipped with Option 010.
Adapter, BNC (m) to SMA (f)	HP 1250-1700	Shipped with Option 026 only.
Connector, APC-3.5 mm (f) to (f)	HP 5061-5311	Shipped with Option 026 only.
Reference Connector	HP 1250-1499	Shipped connected between the 10 MHz REF OUT and the EXT REF IN on the rear panel of the analyzer.
Cable, 50Ω, BNC	HP 8120-2682	Not shipped with Options 001, 011, or 026
Cable, SMA (m) to type N (m)	HP 8120-5148	Not shipped with HP 8591A analyzers or Option 026.
Cable, 75Ω BNC	HP 5062-6452	Shipped with Options 001 or 011 only.
Cable, SMA (m) to SMA (m)	HP 08592-60061	Shipped with Option 026 only.
Power cable	See Table 2-4	Shipped with analyzer

### Preparing the Analyzer for Use

The analyzer is a portable instrument and requires no physical installation other than connection to a power source.

#### Caution



*Do not* connect ac power until you have verified that the line voltage is correct, the proper fuse is installed, and the line voltage selector switch is properly positioned, as described in the following paragraphs. Damage to the equipment could result.

### Power Requirements

**Table 2-3. Power Requirements**

Characteristic	Requirement
Input Voltage	86 to 127, or 195 to 250 V rms
Frequency	47 to 66 Hz
Input Voltage (for 400 Hz operation)	103 to 126 V rms, 400 Hz $\pm$ 10%
Power	<300 VA



## Setting the Line Voltage Selector Switch

### Caution



Before connecting the analyzer to the power source, you must set the rear-panel voltage selector switch correctly to adapt the analyzer to the power source. An improper selector switch setting can damage the analyzer when it is turned on.

Set the instrument's rear-panel voltage selector switch to the line voltage range (115 V or 230 V) corresponding to the available ac voltage. See Figure 2-2. Insert a small screwdriver or similar tool in the slot and slide the switch up or down so that the proper voltage label is visible.

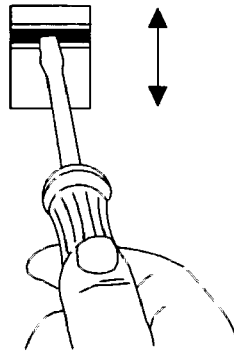

Figure 2-2. Setting the Line Voltage Selector Switch

### Checking the Fuse

The recommended fuse is size 5 by 20 mm, rated F5A, 250 V (IEC approved). This fuse may be used with input line voltages of 115 V or 230 V. Its HP part number is 2110-0709.

In areas where the recommended fuse is not available, a size 5 by 20 mm, rated fast blow, 5 A, 125 V (UL/CSA approved) fuse may be substituted. Use this fuse with an input line voltage of 115 V only. Its HP part number is 2110-0756.

The line fuse is housed in a small container beside the rear-panel power connector (see Figure 2-3). The container provides space for storing a spare fuse, as shown in the figure.

To check the fuse, insert the tip of a screwdriver in the slot at the middle of the container and pry gently to extend the container.

### Note

The fuse container is attached to the line module; it cannot be removed.



The fuse closest to the analyzer is the fuse in use. If the fuse is defective or missing, install a new fuse in the proper position and reinsert the fuse container.

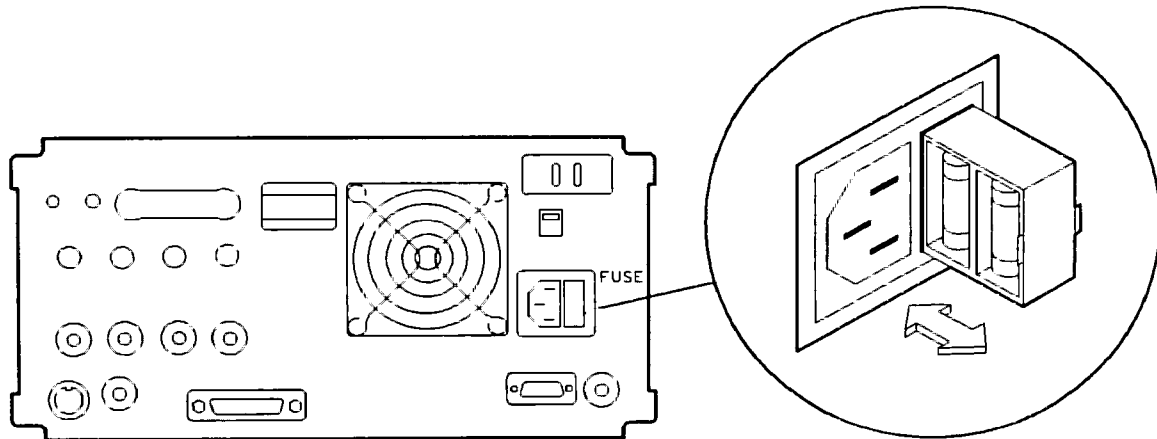

**Figure 2-3. Checking the Line Fuse**

### **Power Cable**

The analyzer is equipped with a three-wire power cable, in accordance with international safety standards. When connected to an appropriate power line outlet, this cable grounds the instrument cabinet.

### **Warning**







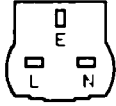

**Failure to ground the analyzer properly can result in personal injury. Before turning on the analyzer, you must connect its protective earth terminals to the protective conductor of the main power cable. Insert the main power cable plug only into a socket outlet that has a protective earth contact. DO NOT defeat the earth-grounding protection by using an extension cable, power cable, or autotransformer without a protective ground conductor.**

**If you are using an autotransformer, make sure its common terminal is connected to the protective earth contact of the power source outlet socket.**

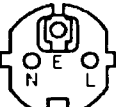
Various power cables are available to connect the analyzer to the types of ac power outlets unique to specific geographic areas. The cable appropriate for the area to which the analyzer is originally shipped is included with the unit. You can order additional ac power cables for use in different areas. Table 2-4 lists the available ac power cables, illustrates the plug configurations, and identifies the geographic area in which each cable is appropriate.

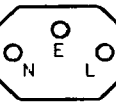
**Table 2-4. AC Power Cables Available**

PLUG TYPE *	CABLE HP PART NUMBER	PLUG DESCRIPTION	CABLE LENGTH CM (INCHES)	CABLE COLOR	FOR USE IN COUNTRY
<b>250V</b> 	8120-1351 8120-1703	Straight**BS1363A 90°	229 (90) 229 (90)	Mint Gray Mint Gray	Great Britain, Cyprus, Nigeria, Rhodesia, Singapore, So Africa, India
<b>250V</b> 	8120-1369 8120-0696	Straight**NZSS198/ASC112 90°	201 (79) 221 (87)	Gray Gray	Australia, New Zealand
<b>250V</b> 	8120-1689 8120-1692	Straight**CEE7-111 90°	201 (79) 201 (79)	Mint Gray Mint Gray	East and West Europe, Saudi Arabia, United Arab Republic (unpolarized in many nations)
<b>125V</b> 	8120-1348 8120-1398 8120-1754	Straight**NEMA5-15P 90° Straight**NEMA5-15P	203 (80) 203 (80) 91 (36)	Black Black Black	United States Canada, Japan (100 V or 200 V), Mexico, Philippines, Taiwan
	8120-1378 8120-1521 8120-1676	Straight**NEMA5-15P 90° Straight**NEMA5-15P	203 (80) 203 (80) 91 (36)	Jade Gray Jade Gray Jade Gray	
<b>250V</b> 	8120-2104	Straight**SEV1011 1959-24507 Type 12	201 (79)	Gray	Switzerland
<b>220V</b> 	8120-0698	Straight**NEMA6-15P			
<b>250V</b> 	8120-1860	Straight**CEE22-VI			
<p>* E = Earth Ground, L = Line, N = Neutral  ** Part number for plug is industry identifier for plug only. Number shown for cable is HP Part Number for complete cable, including plug.</p>					

## Turning on the Analyzer for the First Time

When you turn the analyzer on for the first time, you should perform frequency and amplitude self-calibration routines to generate correction factors and indicate that the unit is functioning correctly.

Perform the following steps:

1. Ensure the reference connector is connected between the 10 MHz OUTPUT and EXT REF IN rear-panel connectors. See Figure 2-4.

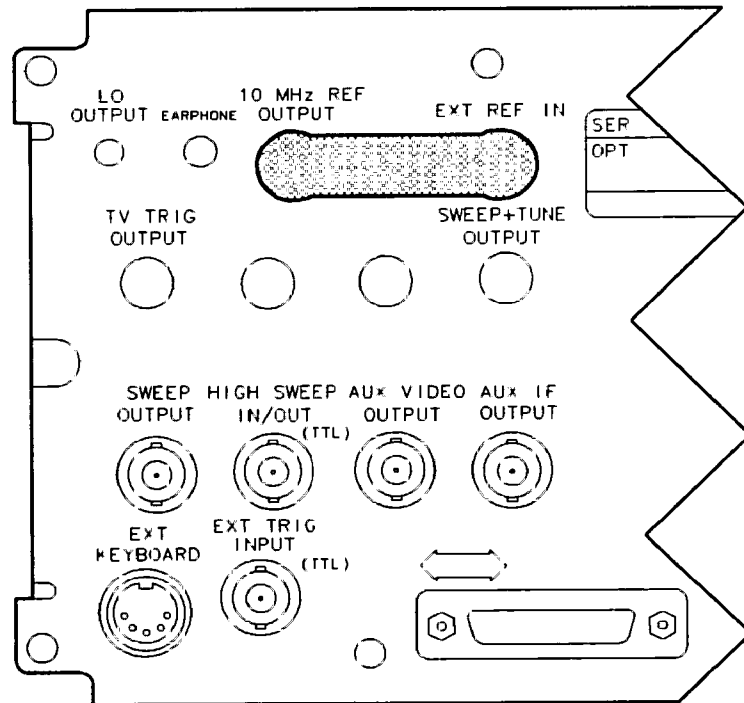

**Figure 2-4. Reference Connector**

If you wish to use an external 10 MHz source as the reference frequency, disconnect the reference connector from the rear-panel and connect an external reference source to the EXT REF IN connector on the rear panel.

2. Plug the power cord into the analyzer.
3. Press **LINE**.

After a few seconds, the screen displays the firmware date (for example, 31.1.89 indicates 31 January 1989).

### Note



Record the firmware date and keep it for reference. If you should ever need to call Hewlett-Packard for service or with any questions regarding your analyzer, it will be helpful to have the firmware date readily available.

If your analyzer is equipped with Option 021 (HP-IB interface), the appropriate interface address (HP-IB ADRS: XX) also appears on the screen.

If your analyzer is equipped with Option 023 (RS-232 interface), the baud rate (RS232: XXXX) is displayed.

4. To meet spectrum analyzer specifications, allow a 30 minute warm-up before attempting to make any calibrated measurements. Be sure to calibrate the analyzer only *after* the analyzer has met the operating temperature conditions.
5. Connect the type N (m) to BNC (f) connector (shipped with the analyzer) to the INPUT 50Ω. Connect the 50Ω coaxial cable (also shipped with the instrument) between the front-panel CAL OUT and the INPUT 50Ω connector.

*Option 001:* Omit the adapter and use the 75Ω cable to connect the CAL OUT and the INPUT 75Ω connectors.

*Option 026:* Connect the SMA (m) to SMA (m) cable to the analyzer input with APC-3.5 mm connector. Connect the cable to CAL OUT with the BNC to SMA adapter.

6. Perform the frequency and amplitude self-calibration routine by pressing **CAL** and **CAL FREQ & AMPTD**.

During the frequency routine, CAL: SWEEP, CAL: FREQ, and CAL: SPAN are displayed as the sequence progresses. For an Option 102, CAL: FM GAIN + OFFSET is also displayed. During the amplitude routine, CAL; AMPTD, CAL: 3 dB BW, CAL: ATTEN, and CAL: LOGAMP are displayed as the sequence progresses. CAL: DONE appears when the routine is completed. Any failures or discrepancies produce a message on the screen; see Appendix A.

7. When the frequency and amplitude self-calibration routines have been completed successfully, store the correction factors by pressing **CAL STORE**.

The self-calibration routines calibrate the analyzer by generating correction factors. The softkey **CAL STORE** stores the correction factors in the area of analyzer memory that is saved when the analyzer is turned off; the analyzer will automatically apply these factors in future measurements. If **CAL STORE** is not pressed, the correction factors remain in effect until the unit is turned off.

For analyzers with Option 010 or 011, the tracking-generator self-calibration routine should be performed prior to using the tracking generator.

---

**Note**

Since the **CAL TRK GEN** routine uses the absolute amplitude level of the analyzer, the analyzer amplitude should be calibrated prior to using **CAL TRK GEN**.

---

1. To calibrate the tracking generator, connect the tracking generator output (RF OUT 50Ω) to the analyzer input connector, using an appropriate cable and BNC-to-Type N adapters.

---

**Note**

A low-loss cable should be used for accurate calibration. Use the 50Ω cable shipped with the analyzer (*Option 011:* use the 75Ω cable shipped with the analyzer).

---

2. Press the following analyzer keys: **CAL**, **MORE 1 of 3**, **MORE 2 of 3**, **CAL TRK GEN**. **TG SIGNAL NOT FOUND** will be displayed if the tracking generator output is not connected to the analyzer input.
3. To save this data in the area of analyzer memory that is saved when the analyzer is turned off, press **CAL STORE**.

For HP 8593A analyzers only, the **CAL YTF** self-calibration routine should be performed periodically. See “When Is Self-Calibration Needed?” in Chapter 5 for some helpful guidelines on how often the self-calibration routines should be performed.

To perform the **CAL YTF** self-calibration routine:

1. Connect a low-loss cable (such as HP part number 8120-5148) from 100 MHz COMB OUT to the analyzer input.
2. Press **CAL**, **CAL YTF**. The YTF self-calibration routine completes in approximately 4 minutes.
3. Press **CAL**, **CAL STORE**.

When the self-calibration routines have been completed successfully, the analyzer is ready for normal operation.

---

## Inserting a Memory Card

Use the following information to ensure that the memory card is inserted correctly. Improper insertion causes error messages to occur, but generally does not damage the card or instrument. Care must be taken, however, not to force the card into place. The cards are easy to insert when installed properly.

1. Locate the arrow printed on the card's label.
2. Insert the card with its arrow matching the raised arrow on the bezel around the card-insertion slot. See Figure 2-5.

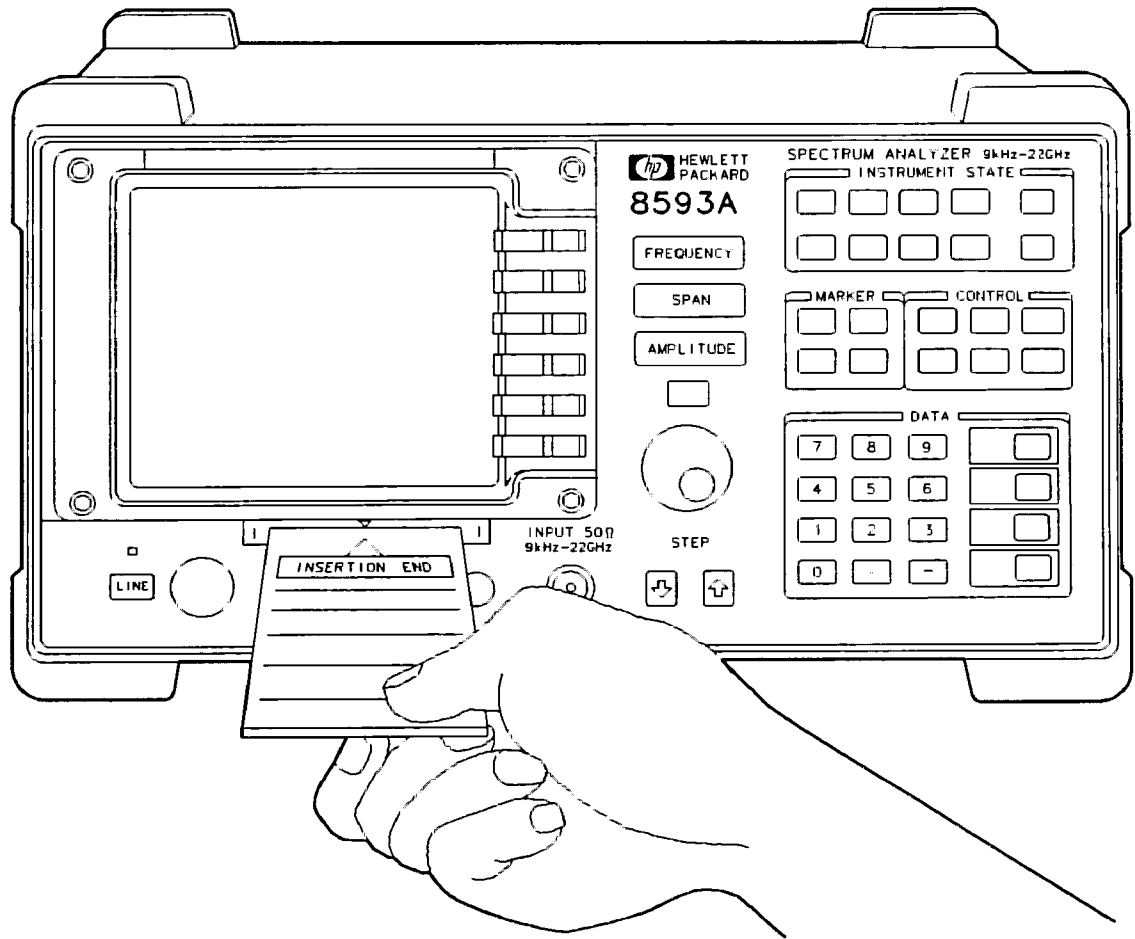

**Figure 2-5. Inserting the Memory Card**

3. Press the card into the slot. When correctly inserted, about 19 mm (0.75 in) of the card is exposed from the slot.

### Changing the Memory Card Battery

It is recommended that the memory card battery be changed every 2 years. The battery is a lithium commercial CMOS type battery, part number CR 2016.

---

#### Note



The minimum lifetime of the battery (under ordinary conditions) is more than 2 years.

---

The date that the memory card battery was installed is either engraved on the side of the memory card or written on a label on the memory card.

If the memory card does not have a label with the date that the battery was installed, use the date code engraved on side of the memory card. The date code engraved on the memory card consists of numbers and letters engraved in the black plastic on the side of the memory card.

(See Figure 2-6). The first number indicates the year, the following two characters indicate the month, and the following number indicates the week in the month that the memory card battery was installed. For example, 80C3 indicates the battery was installed in the third week in October in 1988.

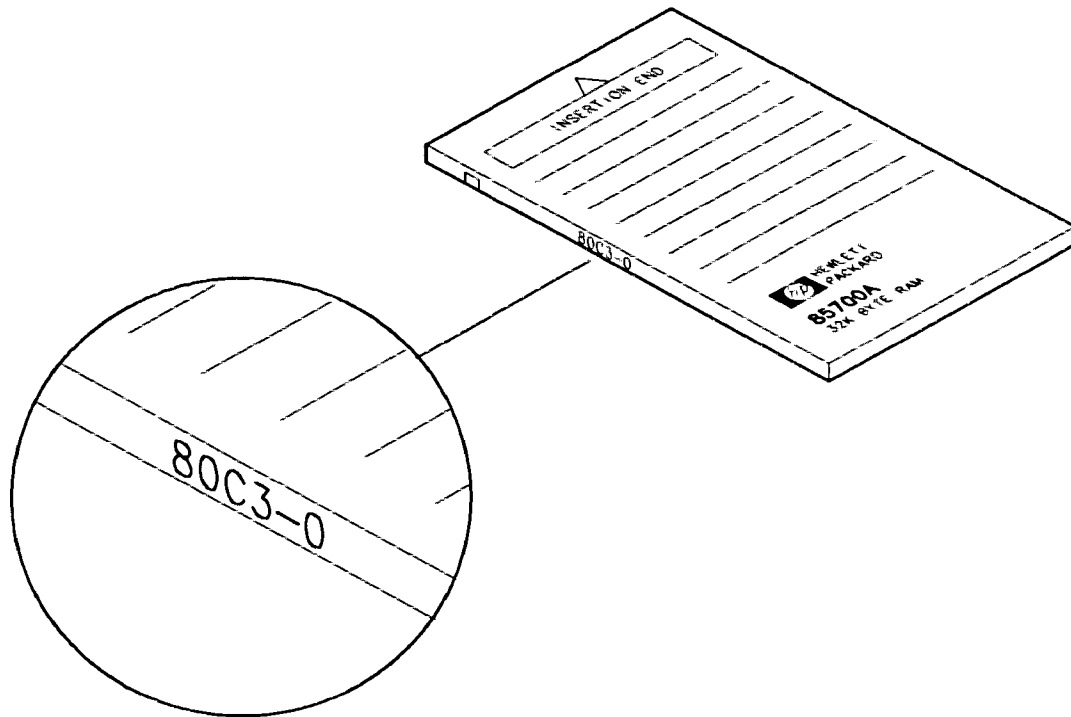

**Figure 2-6. Memory Card Battery Date Code Location**

#### **Procedure to Change the Memory Card Battery**

The battery is located beside the card's write-protect switch on the end opposite the connector.

---

#### **Caution**



The battery power enables the memory card's memory to retain data. You can lose the data when the battery is removed. Replace the battery while the card is installed in a powered-up instrument.

---

1. Locate the groove along the edge of the battery clip. See Figure 2-7.
2. Gently pry the battery clip out of the card. The battery fits within this clip.
3. Replace the battery, making sure the plus (+) sign on the battery is on the same side as the plus (+) sign on the clip.
4. Insert the battery clip into the memory card, holding the clip as oriented in Figure 2-7. (Face the "open" edge of the clip toward the write-protect switch on the memory card.)
5. Write the date that the battery was replaced on the memory card label. This will help you to remember when the battery should be replaced.



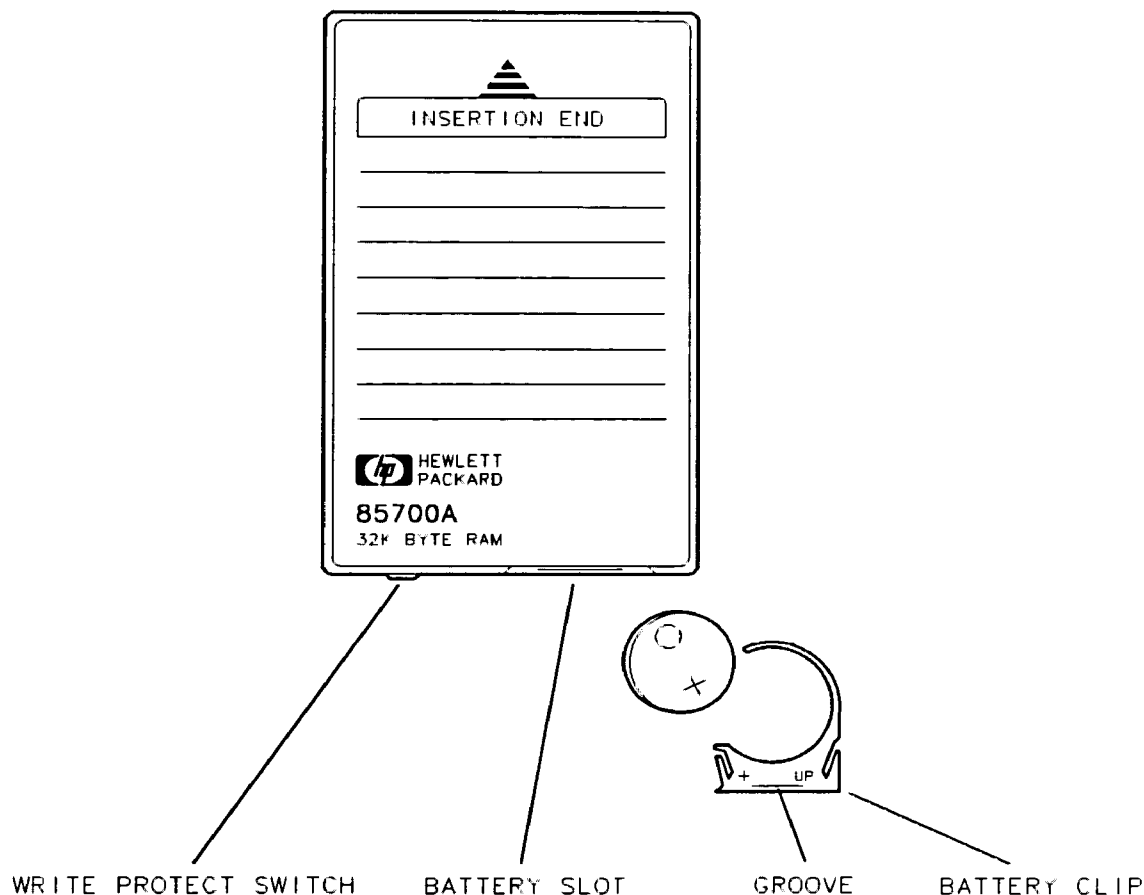

**Figure 2-7. Memory Card Battery Replacement**

## Analyzer Battery Information

The HP 8591A and HP 8593A Spectrum Analyzers use a 3.6 V lithium battery to enable the analyzer memory to retain data. The date when the battery was installed is on a label on the rear panel of the analyzer. (See Figure 2-8.)

The minimum life expectancy of the battery is 8 years at 25°C, or 1 year at 55°C. If you experience problems with the battery or the recommended time period for battery replacement has elapsed, see “How to Return Your Analyzer for Service” in Chapter 8.

If you wish to replace the battery yourself, you can purchase the service documentation that provides all necessary test and maintenance information. The battery is soldered onto the analyzer’s processor board.

You can order the service documentation for the HP 8591A or HP 8593A through your HP Sales and Service office. The package is described under “Service Documentation for the HP 8591A (Option 915)” or “Service Documentation for the HP 8593A (Option 915)” in Chapter 1 of this manual.

After replacing the analyzer battery, write the date of battery replacement on the rear-panel label.

TYPICAL BATTERY LIFE (FOR CALIBRATION & USER MEMORY)	BATTERY INSTALLED
REFER TO SERVICE MANUAL 8 YEARS AT 25°C      1 YEAR AT 55°C	REPLACED

**Figure 2-8. Rear-Panel Battery Information Label**



## Verifying Specified Operation for the HP 8591A

---

### What You'll Find in This Chapter

This chapter contains test procedures which test the electrical performance of the HP 8591A Spectrum Analyzer.

None of the test procedures involve removing the cover of the spectrum analyzer.

### What is Performance Verification?

Performance Verification verifies that the spectrum analyzer performance is within all specifications of Table 1-1. It is time-consuming and requires extensive test equipment. Performance Verification consists of *all* the performance tests. See Table 3-1 for a complete listing of performance tests.

**Table 3-1. Performance Verification Tests for the HP 8591A**

Test Number	Test Name
1.	10 MHz Reference Accuracy (Standard Timebase)
2.	Frequency Readout Accuracy and Marker Count Accuracy
3.	Noise Sidebands
4.	Residual FM
5.	System Related Sidebands
6.	Frequency Span Readout Accuracy
7.	Sweep Time Accuracy
8.	Scale Fidelity
9.	Input Attenuator Accuracy
10.	Reference Level Accuracy
11.	Resolution Bandwidth Switching Uncertainty
12.	Calibrator Amplitude Accuracy
13.	Frequency Response
14.	Spurious Response
15.	Gain Compression
16.	Displayed Average Noise Level
17.	Residual Responses
18.	10 MHz Reference Output Accuracy (Option 004)
19.	Fast Time Domain Sweeps (Option 101)
20.	Absolute Amplitude, Vernier, and Power Sweep Accuracy (Option 010 or 011)
21.	Output Attenuator Accuracy (Option 010 or 011)
22.	Tracking Generator Level Flatness (Option 010 or 011)
23.	Harmonic Spurious Outputs (Option 010 or 011)
24.	Non-Harmonic Spurious Outputs (Option 010 or 011)
25.	Tracking Generator Feedthrough (Option 010 or 011)

## What Is Operation Verification?

Operation Verification consists of a subset of the performance tests which test only the most critical specifications of the analyzer. It requires less time and equipment than the Performance Verification and is recommended for verification of overall instrument operation, either as part of incoming inspection or after repair. Operation Verification consists of the following performance tests:

**Table 3-2. Operation Verification Tests for the HP 8591A**

Test Number	Test Name
2.	Frequency Readout Accuracy and Marker Count Accuracy
3.	Noise Sidebands
6.	Frequency Span Readout Accuracy
8.	Scale Fidelity
9.	Input Attenuator Accuracy
10.	Reference Level Accuracy
11.	Resolution Bandwidth Switching Uncertainty
12.	Calibrator Amplitude Accuracy
13.	Frequency Response
14.	Second Harmonic Distortion (part of Spurious Response)
16.	Displayed Average Noise Level

### Before You Start the Verification Tests

There are four things you should do before starting a verification test:

1. Switch the analyzer on and let it warm up in accordance with the Temperature Stability specification in Table 1-1.
2. Read "Making a Measurement" in Chapter 5.
3. After the analyzer has warmed up as specified, perform the self-calibration procedure documented in "Improving Accuracy With Calibration Routines" in Chapter 5. The performance of the analyzer is only specified after the analyzer calibration routines have been run and if the analyzer is autocoupled.
4. Read the rest of this section before you start any of the tests, and make a copy of the Performance Verification Test Record described in "Recording the Test Results."

---

#### Note



Use only 75Ω cables, connectors, or adapters on the 75Ω input of an Option 001 or damage to the input connector will occur.

---

## **Test Equipment You'll Need**

Table 3-3 lists the recommended test equipment for the performance tests. The table also lists recommended equipment for the analyzer's adjustment procedures which are located in the *HP 8591A Service Manual*. Any equipment that meets the critical specifications given in the table can be substituted for the recommended model(s).

## **Recording the Test Results**

A small test results table is provided at the end of each test procedure for your convenience in recording test results as you perform the procedure.

In addition, a complete Performance Verification Test Record, (Table 3-28), has been provided at the end of the chapter. We recommend that you make a copy of the table, record the test results on the copy, and keep the copy for your calibration test record. This record could prove valuable in tracking gradual changes in test results over long periods of time.

## **If the Analyzer Doesn't Meet Specifications**

If the analyzer fails a test, rerun the **CAL FREQ & AMPTD** routine, press **CAL STORE**, and repeat the test. If the analyzer still fails one or more specifications, complete any remaining tests and record all test results on a copy of the test record. Then refer to "Problems" in Chapter 8, for instructions on how to solve the problem.

## **Periodically Verifying Operation**

The analyzer requires periodic verification of operation. Under most conditions of use, you should test the analyzer at least once a year with either Operation Verification or the complete set of Performance Verification tests.

**Table 3-3. Recommended Test Equipment**

Instrument	Critical Specifications for Equipment Substitution	Recommended Model	Use*
Synthesized Sweeper	Frequency Range: 10 MHz to 1.8 GHz Frequency Accuracy (CW): $\pm 0.02\%$ Leveling Modes: Internal and External Modulation Modes: AM Power Level Range: $-35$ to $+16$ dBm	HP 8340A/B	P,A,T
Synthesizer Function Generator	Frequency Range: 0.1 Hz to 500 Hz Frequency Accuracy: $\pm 0.02\%$ Waveform: Triangle	HP 3325B	P
Synthesizer/Level Generator	Frequency Range: 500 Hz to 80 MHz Amplitude Range: $+12$ to $-85$ dBm Flatness: $\pm 0.15$ dB Attenuator Accuracy: $\pm 0.09$ dB	HP 3335A	P,A,T
AM/FM Signal Generator	Frequency Range: 1 MHz to 1000 MHz Amplitude Range: $-35$ to $+16$ dBm SSB Noise: $< -120$ dBc/Hz at 20 kHz offset	HP 8640B, Option 002	P,A,T
Measuring Receiver	Compatible with Power Sensors dB Relative Mode Resolution: 0.01 dB Reference Accuracy: $\pm 1.2\%$ Tuned RF Level Mode: ‡ Tuned RF Level Accuracy: $< \pm 0.15$ dB Tuned RF Level Frequency: 300 MHz $\pm 1$ MHz	HP 8902A	P,A,T
Power Meter	Power Range: Calibrated in dBm and dB relative to reference power $-70$ dBm to $+44$ dBm, sensor dependent	HP 436A	P,A,T
Power Sensor	Frequency Range: 100 kHz to 1800 MHz Maximum SWR: 1.60 (100 kHz to 300 kHz) 1.20 (300 kHz to 1 MHz) 1.1 (1 MHz to 2.0 GHz) 1.30 (2.0 to 2.9 GHz)	HP 8482A	P,A,T
Power † Sensor	Frequency Range: 1 MHz to 2 GHz Maximum SWR: 1.18 (600 kHz to 2.0 GHz) 75 ohms	HP 8483A	P,A,T
Low-Power Power Sensor	Frequency Range: 300 MHz Amplitude Range: $-20$ dBm to $-70$ dBm Maximum SWR: 1.1 (300 MHz)	HP 8484A	P,A,T

\* P = Performance Test, A = Adjustment, T = Troubleshooting

† Option 001 and Option 011 Only

‡ Tuned RF Level mode required for Options 010 or 011 only.

**Table 3-3. Recommended Test Equipment (continued)**

Instrument	Critical Specifications for Equipment Substitution	Recommended Model	Use*
Microwave Frequency Counter	Frequency Range: 9 MHz to 7 GHz Timebase Accy (Aging): $<5 \times 10^{-10}$ /day	HP 5343A	P,A,T
Frequency Standard	Frequency: 10 MHz Timebase Accy (Aging): $<1 \times 10^{-9}$ /day	HP 5061B	P,A
Oscilloscope	Bandwidth: dc to 100 MHz Vertical Scale Factor of 5 V/Div	HP 1741A	T
Universal † Frequency Counter	Frequency: 10 MHz Resolution: $\pm 0.002$ Hz External Timebase	HP 5334A/B	P,A,T
Digital Voltmeter	Input Resistance: $\geq 10$ megohms Accuracy: $\pm 10$ mV on 100 V range	HP 3456A	P,A,T
DVM Test Leads	For use with HP 3456A	HP 34118	A,T
Spectrum Analyzer	Frequency Range: 10 MHz to 7 GHz Relative Amplitude Accuracy: 100 kHz to 1.8 GHz: $< \pm 1.8$ dB Frequency Accuracy: $< \pm 10$ kHz @ 7 GHz	HP 8566A/B	P,A,T
Minimum † Loss Adapter	50 to 75 ohm, matching Frequency Range: dc to 2 GHz Insertion Loss: 5.7 dB	HP 11852B	P,A,T
Power Splitter	Frequency Range: 50 kHz to 1.8 GHz Insertion Loss: 6 dB (nominal) Output Tracking: $< 0.25$ dB Equivalent Output SWR: $< 1.22:1$	HP 11667A	P,A
Directional Bridge	Frequency Range: 0.1 to 110 MHz Directivity: $> 40$ dB Maximum VSWR: 1.1:1 Transmission Arm Loss: 6 dB (nominal) Coupling Arm Loss: 6 dB (nominal)	HP 8721A	P,T
10 dB Attenuator	Type N (m to f) Frequency: 300 MHz	HP 8491A Option 010	P,A,T
* P = Performance Test, A = Adjustment, T=Troubleshooting			
† Option 001 Only			
‡ Option 004 Only			



**Table 3-3. Recommended Test Equipment (continued)**

Instrument	Critical Specifications for Equipment Substitution	Recommended Model	Use*
1 dB Step Attenuator	Attenuation Range: 0 to 12 dB Frequency Range: 50 MHz Connectors: BNC female	HP 355C	P,A
10 dB Step Attenuator	Attenuation Range: 0 to 30 dB Frequency Range: 50 MHz Connectors: BNC female	HP 355D	P,A
Low Pass Filter	Cutoff Frequency: 50 MHz Rejection at 80 MHz: >50 dB	0955-0306	P,T
Low Pass Filter	Cutoff Frequency: 300 MHz Bandpass Insertion Loss: <0.9 dB at 300 MHz Stopband Insertion Loss: >40 dB at 435 MHz	0955-0455	P,A,T
Termination	Impedance: 50 ohms (nominal) <i>(2 required for option 010)</i>	HP 908A	P,T
Termination †	Impedance: 75 ohms (nominal) <i>(2 required for option 011)</i>	HP 909E Option 201	P,T
Logic Pulser	TTL voltage and current drive levels	HP 546A	T
Digital Current Tracer	Sensitivity: 1 mA to 500 mA Frequency Response: Pulse trains to 10 MHz Minimum Pulse Width: 50 ns Pulse Rise Time: <200 ns	HP 547A	T
Logic Clip	TTL voltage and current drive levels	HP 548A	T
Cable	Type N, 163 cm (72 in)	HP 11500A	P,A,T
Cable	Frequency Range: dc to 1 GHz Length: ≥91 cm (36 in) Connectors: BNC (m) both ends <i>(4 required)</i>	HP 10503A	P,A,T
Cable	Frequency Range dc to 310 MHz Length: 20 cm (9 in) Connectors: BNC (m) both ends	HP 10502A	P,A,T
Cable †	BNC, 75 ohms, 30 cm (12 in)	5062-6452	P,A,T
Cable †	BNC, 75 ohms, 120 cm (48 in)	15525-80010	P,A,T

\* P = Performance Test, A = Adjustment, T=Troubleshooting

† Option 001 Only

**Table 3-3. Recommended Test Equipment (continued)**

Instrument	Critical Specifications for Equipment Substitution	Recommended Model	Use*
Test Cable	Length: $\geq 91$ cm (36 in) Connectors: SMB (f) to BNC (m) (2 required)	85680-60093	A,T
Adapter	Type N (f) to BNC (f)	1250-1474	P,A,T
Adapter	Type N (m) to BNC (f) (4 required)	1250-1476	P,A,T
Adapter	Type N (m) to BNC (m) (2 required)	1250-1473	P,A,T
Adapter	Type N (f) to BNC (m)	1250-1477	P,A,T
Adapter	Type N (m) to APC 3.5 (m)	1250-1743	P,A,T
Adapter	Type N (f) to APC 3.5 (f)	1250-1745	P,A,T
Adapter	APC 3.5 (f) to APC 3.5 (f)	5061-5311	P,A,T
Adapter †	Type N (f) to BNC (m), 75 $\Omega$	1250-1534	P,A,T
Adapter †	BNC (m) to BNC (m), 75 $\Omega$	1250-1288	P,A,T
Adapter	Type N (f) to APC 3.5 (m)	1250-1750	P,A,T
Adapter†	Type N (f), 75 ohms, to Type N (m), 50 ohms	1250-0597	P,A,T
Adapter	BNC (f) to dual banana plug	1251-1277	P,A,T
Adapter	SMB (f) to SMB (f)	1250-0692	A,T
Adapter	SMB (m) to SMB (m)	1250-0813	A,T
Adapter	BNC (m) to BNC (m)	1250-0216	P,A,T
Adapter	BNC tee (m) (f) (f)	1250-0781	T
Adapter	BNC (f) to SMB (m)	1250-1237	A,T
Active Probe	5 Hz to 500 MHz 300 kHz to 3 GHz	HP 41800A HP 85024A	T

\* P = Performance Test, A = Adjustment, T=Troubleshooting

† Option 001 Only

---

## 1. 10 MHz Reference Accuracy (Standard Timebase)

### Specification

Frequency:  $\pm 1 \times 10^{-7}$ /day

Stability:  $\pm 0.5 \times 10^{-6}$

### Related Adjustment

10 MHz Frequency Reference Adjustment (Standard Reference).

---

#### Note



If the spectrum analyzer has Option 004, Precision Frequency Reference installed, perform verification test number 18, "10 MHz Reference Output Accuracy (Option 004)," instead.

---

### Description

A frequency counter, which is locked to a 10 MHz reference, is connected to the CAL OUT. This yields better effective resolution. Two frequency measurements are made 24 hours apart. The difference between the two frequencies is calculated and compared to specification.

The stability is measured by changing the setting of the digital-to-analog converter (DAC) which controls the frequency of the timebase. The frequency difference per DAC step is calculated and compared to the specification.

### Equipment

Frequency Counter ..... HP 5343A  
Frequency Standard—any 10 MHz Frequency Standard with aging rate of  
< $\pm 1 \times 10^{-9}$  per day such as the HP 5061B

#### Cable

BNC Cable, 122 cm (48 in) (2 required) ..... HP 10503A

---

#### Note



The spectrum analyzer must have been stored at room temperature for at least two hours and then allowed to warm up for at least 30 minutes at room temperature before performing this test. Also, the analyzer must remain on at room temperature for the duration of this test.

---

#### Note



The test results will be invalid if REF UNLK is displayed at any time during this test. REF UNLK will be displayed if the internal reference oscillator is unlocked to the 10 MHz reference. A REF UNLK might occur if there is a hardware failure or if the jumper between 10 MHz REF OUTPUT and EXT REF IN on the rear panel is removed.

---

## 1. 10 MHz Reference Accuracy (Standard Timebase)

### Procedure

1. Connect the equipment as shown in Figure 3-1.

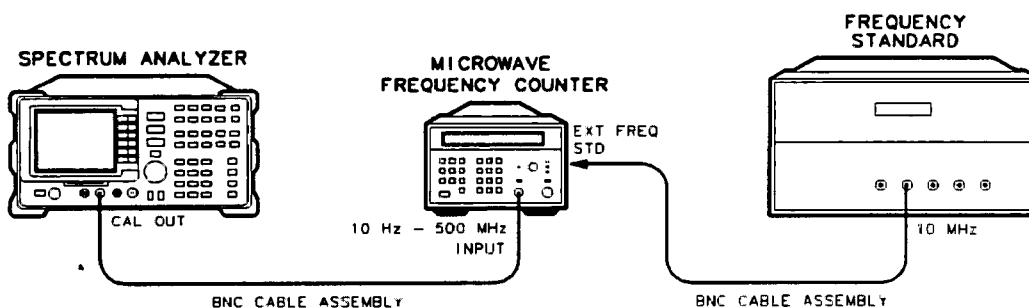

Figure 3-1. 10 MHz Reference Accuracy Test Setup (Standard Reference)

2. Set the frequency counter controls as follows:

SAMPLE RATE .....	Midrange
50 $\Omega$ /1 $\Omega$ SWITCH .....	50 $\Omega$
10Hz-500MHz/500MHz-26.5GHz SWITCH .....	10Hz-500MHz
FREQUENCY STANDARD (Rear panel) .....	EXTERNAL

3. Wait for the frequency counter reading to settle. Record the frequency counter reading to one Hz resolution:

Reading 1 \_\_\_\_\_ Hz

4. Wait 24 hours before proceeding with the next step. Other performance tests may be run during this 24 hour period under the following conditions:
  - a. The analyzer is powered on at all times.
  - b. The analyzer is always at room temperature.
  - c. The jumper between 10 MHz REF OUTPUT and EXT REF IN on the rear panel is always present.

The CAL OUT may be disconnected from the frequency counter during the 24 hour waiting period.

5. Reconnect the CAL OUT to the 10Hz-500MHz input of the frequency counter, if necessary, and wait for the reading to settle. Record the frequency counter reading here to one Hz resolution.

Reading 2 \_\_\_\_\_ Hz

**1. 10 MHz Reference Accuracy (Standard Timebase)**

6. Subtract Reading 2 (step 5) from Reading 1 (step 3) and record the result below as the Frequency Drift.

Frequency Drift \_\_\_\_\_ Hz

7. Calculate the aging by dividing the frequency drift by 300 MHz. The aging should be less than  $\pm 1 \times 10^{-7}$ .

$$\text{Aging} = \text{Frequency Drift} / 300 \times 10^6$$

Aging \_\_\_\_\_

8. On the spectrum analyzer, press:

**FREQUENCY** -37 **Hz**

**CAL** MORE 1 of 3 MORE 2 of 3 VERIFY TIMEBASE.

9. Record the number in the active function block here.

Timebase DAC Setting \_\_\_\_\_

10. Add one to the Timebase DAC Setting recorded in step 9 and enter this number using the DATA keys.

Reading 3 \_\_\_\_\_ Hz

11. Subtract one from the Timebase DAC Setting recorded in step 9 and enter this number using the number keypad. For example, if the timebase DAC setting is 105, press 1, 0, 4, **Hz**. Wait for the frequency counter reading to settle and record the reading here to one Hertz resolution.

Reading 4 \_\_\_\_\_ Hz

12. Calculate the frequency difference between Reading 3 and Reading 2 and between Reading 4 and Reading 2. Record the difference with the greatest absolute value below as the frequency settability.

Frequency Settability \_\_\_\_\_ Hz

**1. 10 MHz Reference Accuracy (Standard Timebase)**

13. Calculate the settability by dividing the frequency settability by 300 MHz and record the result below. The settability should be less than  $\pm 0.5 \times 10^{-6}$ .

$$\text{Settability} = \text{Frequency Settability} / 300 \times 10^{-6}$$

Settability \_\_\_\_\_

Press **PRESET** on the spectrum analyzer. The timebase DAC will be reset automatically to the value recorded in step 9.

---

## 2. Frequency Readout Accuracy and Marker Count Accuracy

### Specification

Frequency Readout Accuracy:

$\pm(\text{Frequency Readout} \times \text{Frequency Reference Accuracy} + 3\% \text{ of SPAN setting} + 20\% \text{ of RES BW setting} + 1.5 \text{ kHz})$ .

Marker Count Accuracy:

Spans  $\leq 10$  MHz

$\pm(\text{Marker Frequency} \times \text{Frequency Reference Accuracy} + \text{Counter Resolution} + 100 \text{ Hz})$ .

Spans  $> 10$  MHz

$\pm(\text{Marker Frequency} \times \text{Frequency Reference Accuracy} + \text{Counter Resolution} + 1000 \text{ Hz})$ .

### Related Adjustment

Sampler Match Adjustment.

### Description

The frequency readout accuracy of the HP 8591A is tested with an input signal of known frequency. By using the same frequency standard for the analyzer and the synthesized sweeper, the frequency reference error is eliminated.

### Equipment

Synthesized Sweeper ..... HP 8340A/B

#### Adapters

Type N (f) to APC 3.5 (m) ..... 1250-1750

APC 3.5 (f) to APC 3.5 (f) ..... 5061-5311

#### Cables

Type N, 183 cm (72 in) ..... HP 11500A

BNC, 122 cm (48 in) ..... HP 10503A

### Additional Equipment Option 001

Minimum Loss Adapter ..... HP 11852B

Adapter Type N (f) to BNC (m), 75 $\Omega$  ..... 1250-1534

## 2. Frequency Readout Accuracy and Marker Count Accuracy

### Procedure

#### Frequency Readout Accuracy

1. Connect the equipment as shown in Figure 3-2. Connect the 10 MHz REF OUT of the HP 8340A/B to the EXT REF IN of the analyzer.

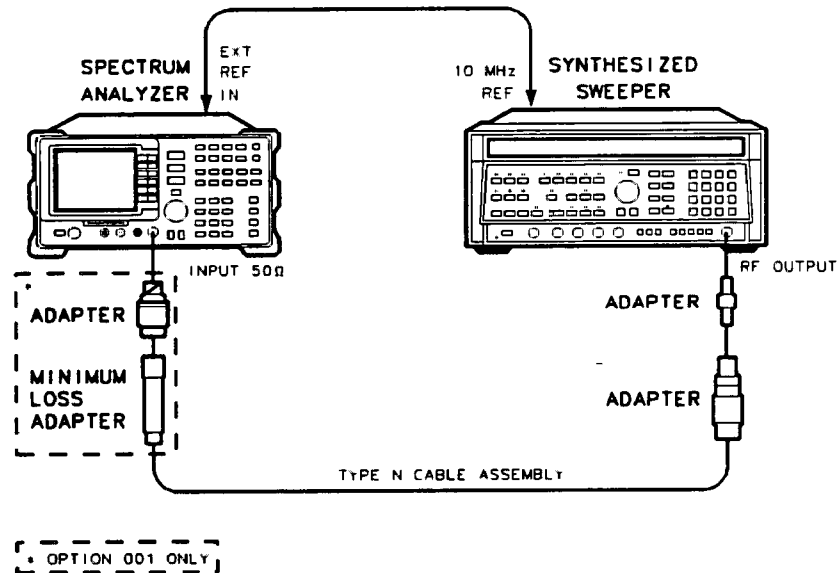

Figure 3-2. Frequency Readout Accuracy Test Setup

2. Press **INSTR PRESET** on the HP 8340A/B and set the controls as follows:  
CW ..... 1.5 GHz  
POWER LEVEL ..... -10 dBm
3. Press **PRESET** on the HP 8591A and wait for the preset to finish. Set the controls as follows:  
CENTER FREQUENCY ..... 1.5 GHz  
SPAN ..... 20 MHz
4. On the HP 8591A, press **PEAK SEARCH**. Record the MKR frequency reading in Table 3-4. The reading should be within the limits shown.
5. Repeat step 4 for HP 8591A frequency spans listed in Table 3-4.



## 2. Frequency Readout Accuracy and Marker Count Accuracy

**Table 3-4. Frequency Readout Accuracy**

HP 8591A	MKR Reading		
Span (MHz)	Min (MHz)	Actual (MHz)	Max (MHz)
20	1499.38	_____	1500.62
10	1499.68	_____	1500.32
1	1499.967	_____	1500.034

### Marker Count Accuracy

6. On the 8591A, press **MKR**, MKR CNT ON OFF (ON), MORE 1 of 2, CNT RES AUTO MAN, 10 **Hz**.
7. Set the HP 8591A resolution bandwidth to 300 kHz.
8. Key in the HP 8591A span settings as indicated in Table 3-5. Press **PEAK SEARCH** and wait for a count to be taken (it may take several seconds). Record the CNT frequency in Table 3-5. The CNT frequency reading should be within the limits shown.

**Table 3-5. Marker Count Accuracy**

HP 8591A	CNT Mkr Frequency		
Span (MHz)	Min (MHz)	Actual (MHz)	Max (MHz)
1	1499.99899	_____	1500.00011
20	1499.99989	_____	1500.00101

## 3. Noise Sidebands

### Specification

$\leq 95$  dBc/Hz at  $>30$  kHz offset from CW signal.

### Description

A 500 MHz CW signal is applied to the input of the spectrum analyzer. The marker functions are used to measure the amplitude of the carrier and the noise level 30 kHz above and below the carrier. The difference between these two measurements is compared to specification.

### Equipment

Signal Generator ..... HP 8640B

#### Cable

Type N, 183 cm (72 in) ..... HP 11500A

### Additional Equipment for Option 001

Minimum Loss Adapter ..... HP 11852B  
Adapter Type N (f) to BNC (m),  $75\Omega$  ..... 1250-1534

### Procedure

1. Set the HP 8640B controls as follows:

FREQUENCY ..... 500 MHz  
OUTPUT LEVEL ..... 0 dBm  
AM ..... OFF  
FM ..... OFF  
COUNTER ..... INT  
RF ..... ON

2. Connect the equipment as shown in Figure 3-3.

3. Press **PRESET** on the HP 8591A and wait for the preset to finish. Set the controls as follows:

CENTER FREQUENCY ..... 500 MHz  
SPAN ..... 10 MHz

4. On the 8591A, press the following analyzer keys:

**PEAK SEARCH** **SIGNAL TRACK** (ON)  
**SPAN** 200 **kHz**  
**BW** RES BW AUTO MAN 1 **kHz**  
VID BW AUTO MAN 30 **Hz**  
**SIGNAL TRACK** (OFF) **SGL SWP** **PEAK SEARCH**.

### 3. Noise Sidebands

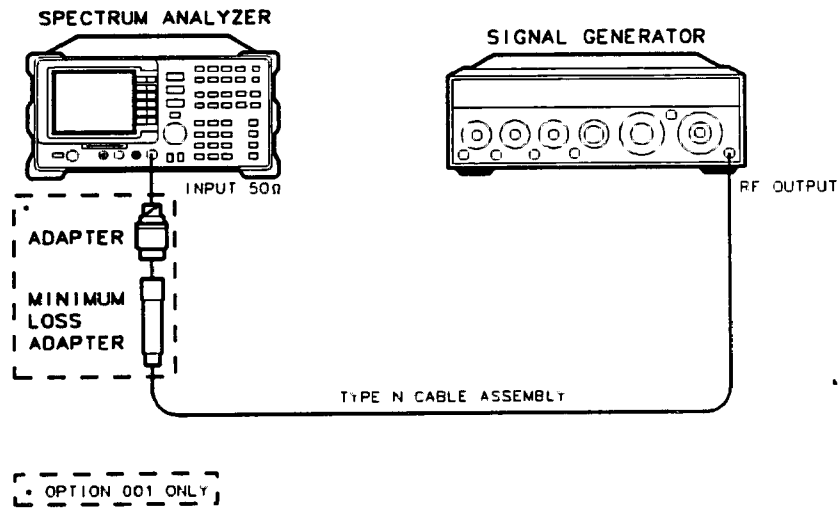

**Figure 3-3. Noise Sidebands Test Setup**

5. Record the MKR amplitude reading as the Carrier Amplitude.

Carrier Amplitude \_\_\_\_\_ dBm

*(Option 001)* Carrier Amplitude \_\_\_\_\_ dBmV

6. Press the following analyzer keys:

MARKER DELTA 30 **[kHz]**

**[MKR]** MARKER NORMAL .

Record the MKR amplitude reading as the Noise Sideband Level at +30 kHz.

Noise Sideband Level at +30 kHz \_\_\_\_\_ dBm

*(Option 001)* Noise Sideband Level at +30 kHz \_\_\_\_\_ dBmV

### 3. Noise Sidebands

7. Press **PEAK SEARCH**, **MARKER DELTA**, **-30 kHz**, **MKR**, **MARKER NORMAL**. Record the MKR amplitude reading as the Noise Sideband Level at -30 kHz.

Noise Sideband Level at -30 kHz \_\_\_\_\_ dBm

*(Option 001)*Noise Sideband Level at -30 kHz \_\_\_\_\_ dBmV

8. Record the more positive value from steps 6 and 7 above and record as the Maximum Noise Sideband Level.

Maximum Noise Sideband Level \_\_\_\_\_ dBm

*(Option 001)*Maximum Noise Sideband Level \_\_\_\_\_ dBmV

9. Subtract the Carrier Amplitude (step 5) from the Maximum Noise Sideband Level (step 8) and record as the Noise Sideband Suppression. The suppression should be  $< -65$  dBc.

Noise Sideband Suppression = Maximum Noise Sideband Level - Carrier Amplitude

Noise Sideband Suppression \_\_\_\_\_ dBc

---

#### Note



The resolution bandwidth is normalized to 1 Hz as follows:

1 Hz noise-power = (noise-power in dBc) - (10 × log (RBW)).

For example, -65 dBc in a 1 kHz resolution bandwidth is normalized to -95 dBc/Hz.

---

---

## 4. Residual FM

### Specification

<250 Hz peak to peak in 100 ms.

### Description

This test measures the inherent short-term instability of the spectrum analyzer's LO system. With the analyzer in zero span, a stable signal is applied to the input and slope-detected on the linear portion of the IF bandwidth filter skirt. Any instability in the LO transfers to the IF signal in the mixing process. The test determines the slope of the IF filter in Hz/dB and then measures the signal amplitude variation caused by the residual FM. Multiplying these two values yields the residual FM in Hz.

### Equipment

Signal Generator ..... HP 8640B

### Cable

Type N, 183 cm (72 in) ..... HP 11500A

### Additional Equipment Option 001

Minimum Loss Adapter ..... HP 11852B

Adapter Type N (f) to BNC (m), 75Ω ..... 1250-1534

### Procedure

#### Determining the IF Filter Slope

1. Connect the equipment as shown in Figure 3-4.

2. Set the HP 8640B controls as follows:

FREQUENCY ..... 500 MHz

CW OUTPUT ..... -10 dBm

CW OUTPUT (*Option 001*) ..... -4 dBm

3. Press **PRESET** on the HP 8591A and wait for the preset to finish. Set the controls as follows:

CENTER FREQUENCY ..... 500 MHz

SPAN ..... 1 MHz

*Option 001 Only:* Press **AMPLITUDE**, MORE 1 of 2, AMPTD UNITS, dBm.

REF LEVEL ..... -9 dBm

LOG dB/DIV ..... 1 dB

RES BW ..... 1 kHz

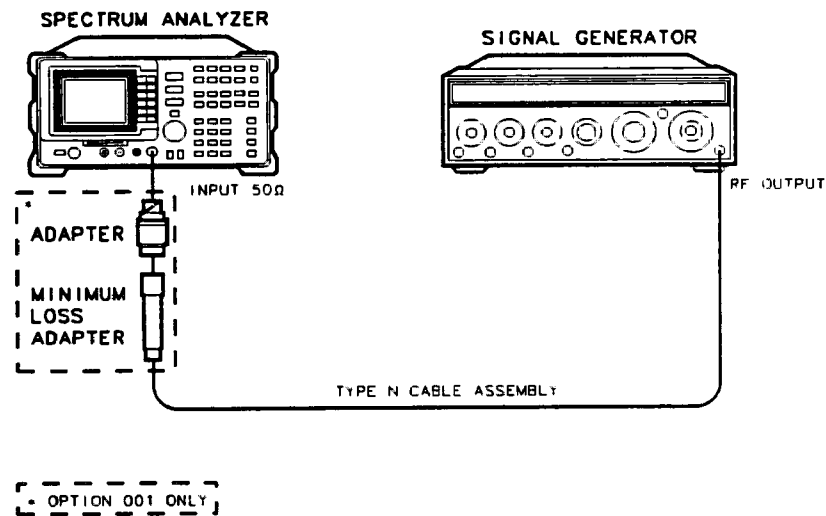

Figure 3-4. Residual FM Test Setup

4. On the HP 8591A, press the following keys:

**PEAK SEARCH** **SIGNAL TRACK** (ON)  
**SPAN** 10 **(kHz)**.

Wait for the AUTO ZOOM message to disappear. Press the following analyzer keys:

**MKR ->** **MARKER -> REF LVL**  
**SIGNAL TRACK** (OFF) **MKR**  
**MARKERS OFF**.

5. On the HP 8591A, press **(SGL SWP)**, **(PEAK SEARCH)**, **MARKER DELTA**.
6. Rotate the HP 8591A knob counterclockwise until the MKR- $\Delta$  amplitude reads  $-1 \text{ dB} \pm 0.1 \text{ dB}$ . Press **MARKER DELTA**. Rotate the knob counterclockwise until the MKR- $\Delta$  amplitude reads  $-4 \text{ dB} \pm 0.1 \text{ dB}$ .
7. Divide the MKR- $\Delta$  frequency in Hertz by the MKR- $\Delta$  amplitude in dB to obtain the slope of the resolution bandwidth filter. For example, if the MKR- $\Delta$  frequency is 1.08 kHz and the MKR- $\Delta$  amplitude is 3.92 dB, the slope would be equal to 275.5 Hz/dB. Record the result below:

Slope \_\_\_\_\_ Hz/ dB

#### 4. Residual FM

##### Measuring the Residual FM

- On the HP 8591A, press **(MKR)**, **MARKERS OFF**, **(PEAK SEARCH)**, and **MARKER DELTA**. Rotate the knob counterclockwise until the MKR- $\Delta$  amplitude reads  $-3 \text{ dB} \pm 0.1 \text{ dB}$ .
- On the HP 8591A, press the following keys:

**(MKR)** **MARKER NORMAL** **(MKR ->)**  
**MARKER -> CF** **(SGL SWP)**  
**(SPAN)** **0** **(Hz)**  
**(SWEEP)** **100** **(ms)**.

Press **(SGL SWP)**.

##### Note



The displayed trace should be about three divisions below the reference level. If it is not, press **(TRIG)**, **SWEEP CONT SGL (CONT)**, **(FREQUENCY)**, and use the knob to place the displayed trace about three divisions below the reference level. Press **(SGL SWP)**.

- On the analyzer, press **(MKR)**, **MORE 1 of 2**, **PK - PK MEAS**. Read the MKR- $\Delta$  amplitude, take its absolute value, and record the result as the Deviation.

Deviation \_\_\_\_\_ dB

- Calculate the Residual FM by multiplying the Slope recorded in step 7 by the Deviation recorded in step 10. The residual FM should be less than 250 Hz.

Residual FM \_\_\_\_\_ Hz

## 5. System Related Sidebands

### Specification

<-65 dBc at >30 kHz from CW signal.

### Description

A 500 MHz CW signal is applied to the input of the spectrum analyzer. The marker functions are used to measure the amplitude of the carrier and the amplitude of any system related sidebands 30 kHz above and below the carrier. System related sidebands are any internally generated, line related, power supply related or local oscillator related sidebands.

### Equipment

Signal Generator ..... HP 8640B

#### Cable

Cable, Type N, 183 cm (72 in) ..... HP 11500A

### Additional Equipment for Option 001

Minimum Loss Adapter ..... HP 11852B  
Adapter Type N (f) to BNC (m), 75Ω ..... 1250-1534

### Procedure

1. Set the HP 8640B controls as follows:

FREQUENCY ..... 500 MHz  
OUTPUT LEVEL ..... 0 dBm  
AM ..... OFF  
FM ..... OFF  
COUNTER ..... INT  
RF ..... ON

2. Connect the equipment as shown in Figure 3-5.
3. Press **PRESET** on the HP 8591A and wait for the preset to finish. Set the controls as follows:

CENTER FREQUENCY ..... 500 MHz  
SPAN ..... 10 MHz

4. On the HP 8591A, press the following analyzer keys:

**PEAK SEARCH** **SIGNAL TRACK** (ON)  
**SPAN** 200 (kHz)  
**BW** 1 (kHz)  
VID BW AUTO MAN 30 (Hz)  
**SIGNAL TRACK** (OFF)  
**FREQUENCY** CF STEP AUTO MAN 130 (kHz).



## 5. System Related Sidebands

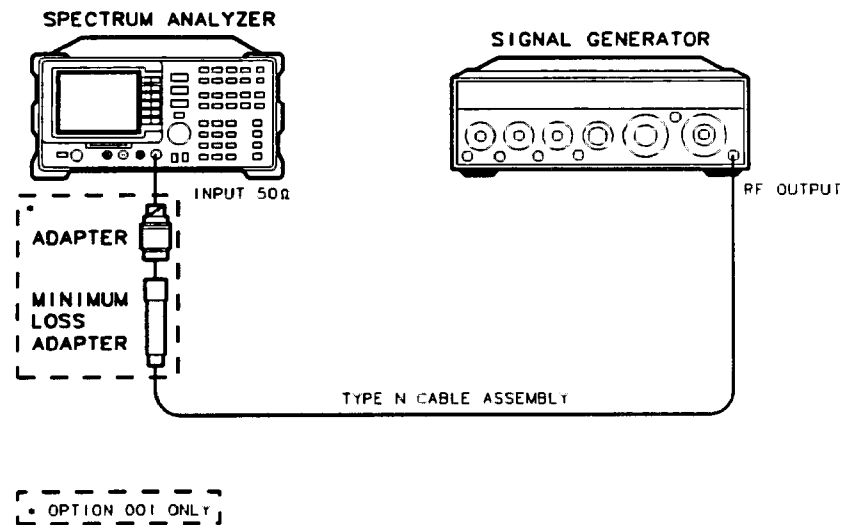

**Figure 3-5. System Related Sidebands Test Setup**

5. On the analyzer, press **SGL SWP** and wait for the completion of the sweep. Press **PEAK SEARCH**, **MARKER DELTA**.
6. On the HP 8591A, press the following analyzer keys:  
**FREQUENCY** **▲** (step-up key) **SGL SWP**.
7. Wait for the completion of a new sweep. Press **PEAK SEARCH**. Record the Marker  $\Delta$  Amplitude:

Marker  $\Delta$  Amplitude \_\_\_\_\_ dBc

The marker  $\Delta$  amplitude above the signal should be  $< -65$  dB.

8. On the HP 8591A, press the following analyzer keys:  
**▼** (step-down key) **▼** (step-down key)  
**SGL SWP**.
9. Wait for the completion of a new sweep. Press **PEAK SEARCH**. Record the Marker  $\Delta$  Amplitude:

Marker  $\Delta$  Amplitude \_\_\_\_\_ dBc

The marker  $\Delta$  amplitude below the signal should be  $< -65$  dB.

## 6. Frequency Span Readout Accuracy

### Specification

- ±2% of span, span ≤10 MHz.
- ±3% of span, span >10 MHz.

### Description

For testing each frequency span, two synthesized sources are used to provide two precisely-spaced signals. The analyzer's marker functions are used to measure this frequency difference and the marker reading is compared to the specification.

### Equipment

Synthesized Sweeper .....	HP 8340A/B
Signal Generator .....	HP 8640B
Power Splitter .....	HP 11667A

### Adapters

Type N (m) to Type N (m) .....	1250-1475
Type N (f) to APC 3.5 (f) .....	1250-1745

### Cables

Type N, 183 cm (72 in) .....	HP 11500A
Type N, 152 cm (60 in) .....	HP 11500D

### Additional Equipment for Option 001

Minimum Loss Adapter .....	HP 11852B
Adapter Type N (f) to BNC (m), 75Ω .....	1250-1534

### Procedure

#### Spans ≥500 MHz

1. Connect the equipment as shown in Figure 3-6. Note that the Power Splitter is used as a combiner. *Option 001 only:* Connect the minimum loss adapter to the INPUT 75Ω using the appropriate adapters.
2. Press **PRESET** on the analyzer and wait for the preset to finish. Set the controls as follows:

CENTER FREQUENCY .....	900 MHz
SPAN .....	500 MHz

## 6. Frequency Span Readout Accuracy

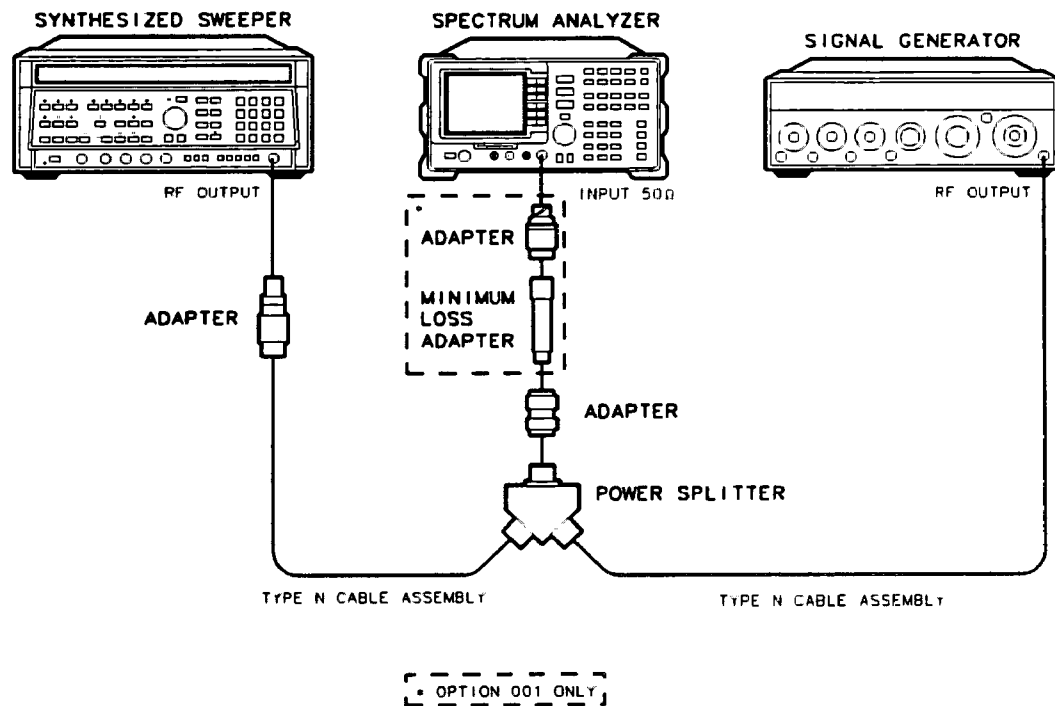

**Figure 3-6. Frequency Span Accuracy Test Setup**

3. Press **INSTR PRESET** on the HP 8340A/B and set the controls as follows:
 

CW .....	1100 MHz
POWER LEVEL .....	-5 dBm
4. On the HP 8640B set the controls as follows:
 

FREQUENCY (LOCKED MODE) .....	700 MHz
CW OUTPUT .....	0 dBm
5. Adjust the analyzer's center frequency, if necessary, to place the lower frequency on the second vertical graticule line (one division from the left-most graticule line).
6. Press **SGL SWP**, **PEAK SEARCH**. If necessary, continue pressing **NEXT PEAK** until the marker is on the left-most signal. This is the "marked" signal.
7. Press **MARKER DELTA** and continue pressing **NEXT PK RIGHT**. The marker  $\Delta$  should be on the right-most signal.
8. Record the MKR  $\Delta$  frequency reading in Table 3-6. The MKR reading should be within the limits shown.
9. On the 8591A, press **MKR**, **MARKERS OFF**, **TRIG**, **FREE RUN**.
10. Repeat steps 5 through 9 for the remaining Span settings listed in Table 3-6. Adjust the frequency of each source for the corresponding new span settings.

## 6. Frequency Span Readout Accuracy

**Table 3-6. Frequency Span Readout Accuracy, Spans  $\geq 500$  MHz**

Span Setting	HP 8642A Setting	HP 8340A/B Setting	MKR- $\Delta$ Freq. Reading		
			Min	Actual	Max
500 MHz	700 MHz	1100 MHz	385 MHz	_____	415 MHz
1000 MHz	500 MHz	1300 MHz	770 MHz	_____	830 MHz
1800 MHz	200 MHz	1700 MHz	1446 MHz	_____	1554 MHz

### Spans $< 500$ MHz

11. Press **PRESET** on the analyzer and wait for the PRESET to finish. Set the control as follows:

CENTER FREQUENCY ..... 70 MHz  
 SPAN ..... 100 MHz

12. Press **INSTR PRESET** on the HP 8340A/B and set the controls as follows:

CW ..... 110 MHz  
 POWER LEVEL ..... -5 dBm

13. Set the HP 8640B controls as follows:

FREQUENCY ..... 30 MHz  
 AMPLITUDE ..... 0 dBm

14. If necessary, adjust the analyzer center frequency to center the two signals on the display.

15. On the analyzer, press the following keys:

**PEAK SEARCH** **MARKER DELTA** **NEXT PEAK** .

The two markers should be on the signals near the second and tenth vertical graticule lines (the first graticule line is the left-most).

16. Record the MKR- $\Delta$  frequency reading in Table 3-7. The MKR- $\Delta$  frequency reading should be within the limits shown.

17. Press **MKR**, **MARKERS OFF** .

18. Repeat steps 13 through 16 for the remaining span settings listed in Table 3-7, setting the HP 8340A/B CW and HP 8640B frequency as shown in the table.

## 6. Frequency Span Readout Accuracy

**Table 3-7. Frequency Span Readout Accuracy, Spans <500 MHz**

HP 8640B Frequency	HP 8340A/B Frequency	HP 8591A Span Setting	MKR- $\Delta$ Reading		
			Min	Actual	Max
30.0	110.0	100 MHz	77.0 MHz	_____	83.0 MHz
50.0	90.0	50 MHz	38.5 MHz	_____	41.5 MHz
62.0	78.0	20 MHz	15.40 MHz	_____	16.60 MHz
66.0	74.0	10 MHz	7.80 MHz	_____	8.20 MHz
68.0	72.0	5 MHz	3.900 MHz	_____	4.100 MHz
69.2	70.8	2 MHz	1.560 MHz	_____	1.640 MHz
69.6	70.4	1 MHz	780.0 kHz	_____	820.0 kHz
69.8	70.2	500 kHz	390.0 kHz	_____	410.0 kHz
69.92	70.08	200 kHz	156.0 kHz	_____	164.0 kHz
69.96	70.04	100 kHz	78.0 kHz	_____	82.0 kHz

---

## 7. Sweep Time Accuracy

### Specification

20 ms to 100 s  $< \pm 3\%$ .

### Description

This test uses a synthesizer function generator to amplitude modulate a 500 MHz CW signal from another signal generator. The analyzer demodulates this signal in zero span to display the response in the time domain. The marker delta frequency function on the analyzer is used to read out the sweep time accuracy.

### Equipment

Synthesizer/Function Generator ..... HP 3325A  
 Signal Generator ..... HP 8640B

### Cables

Type N Cable, 152 cm (60 in) ..... HP 11500D  
 BNC, 120 cm (48 in) ..... HP 10503A

### Additional Equipment for Option 001

Minimum Loss Adapter ..... HP 11852B  
 Adapter Type N (f) to BNC (m), 75 $\Omega$  ..... 1250-1534

### Procedure

---

**Note** For Option 101: perform verification test number 19, "Fast Time Domain Sweeps (Option 101)," in addition to this test.



- 
1. Set the signal generator to output a 500 MHz, -10 dBm, CW signal. Set the AM and FM controls to off. *Option 001:* Set the output to -4 dBm.
  2. Set the synthesizer function generator to output a 500 Hz, +5 dBm triangle waveform signal.
  3. Connect the equipment as shown in Figure 3-7.

## 7. Sweep Time Accuracy

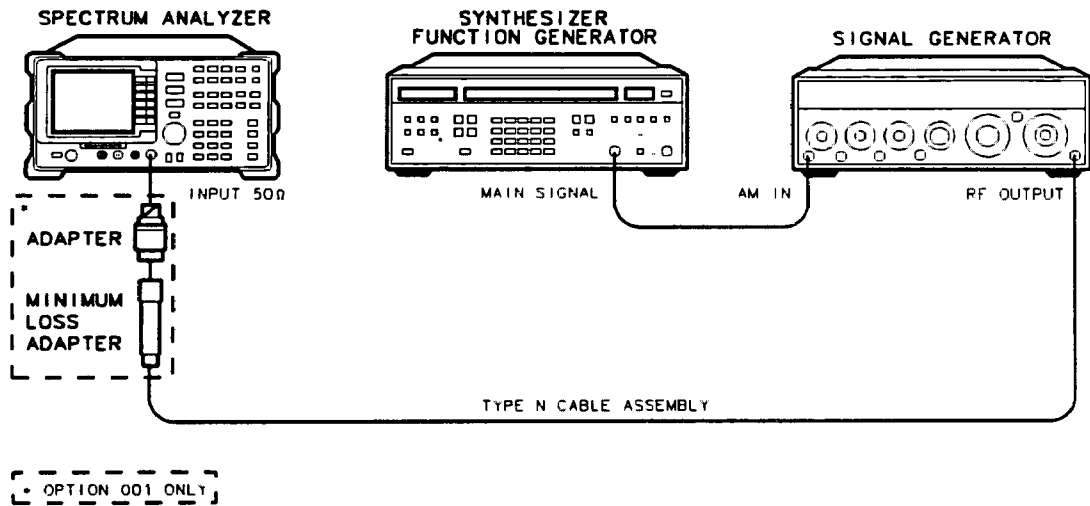

**Figure 3-7. Sweep Time Accuracy Test Setup**

4. Press **PRESET** on the analyzer and wait for the preset to finish. Set the controls as follows:

CENTER FREQUENCY ..... 500 MHz  
 SPAN ..... 10 MHz

- Press **PEAK SEARCH**. Set the controls as follows:

SIGNAL TRACK ..... ON  
 SPAN ..... 50 kHz

Wait for the AUTO ZOOM routine to finish. Press **SPAN**, ZERO SPAN.

Set the controls as follows:

RES BW ..... 3 MHz  
 AMPLITUDE SCALE ..... LINEAR  
 SWEEP TIME ..... 20 ms

Adjust signal amplitude for a mid-screen display.

5. Set the signal generator AM switch to the AC position.
6. On the analyzer, press the following keys:  
**TRIG** VIDEO .  
 Adjust the video trigger so that the analyzer is sweeping.
7. Press **SGL SWP**. After the completion of the sweep, press **PEAK SEARCH**. If necessary, press **NEXT PEAK** until the marker is on the left most signal. This is the "marked signal."
8. Press **MARKER DELTA** and press **NEXT PK RIGHT** until the marker delta is on the eighth signal peak. Record the marker  $\Delta$  reading in Table 3-8.
9. Repeat steps 6 through 9 for the remaining sweep time settings listed in Table 3-8.

7. Sweep Time Accuracy

Table 3-8. Sweep Time Accuracy

HP 8591A Sweep Time Setting	HP 3325A Frequency	Minimum Reading	MKR $\Delta$	Maximum Reading
20 ms	500 Hz	15.4 ms	_____	16.6 ms
50 ms	200 Hz	38.5 ms	_____	41.5 ms
100 ms	100 Hz	77.0 ms	_____	83.0 ms
500 ms	20 Hz	385.0 ms	_____	415.0 ms
1 s	10 Hz	770.0 ms	_____	830.0 ms
10 s	1 Hz	7.7 s	_____	8.3 s
50 s	0.2 Hz	38.5 s	_____	41.5 s
100 s	0.1 Hz	77.0 s	_____	83.0 s



---

## 8. Scale Fidelity

### Specification

#### Log Mode:

- ±0.2 dB/2 dB 0 to -70 dB from Reference Level range.
- ±0.75 dB maximum over 0 to -60 dB from REF LEVEL.
- ±1.0 dB maximum over 0 to -70 dB from REF LEVEL.

#### Linear Mode:

- ±3% of REF LEVEL

#### Log to Linear Switching Uncertainty:

- ±0.25 dB at the Reference Level.

### Related Adjustment

Log and Linear Amplitude Adjustment.

### Description

A 50 MHz CW signal is applied to the INPUT 50Ω of the analyzer through two step attenuators. The attenuators increase the effective amplitude range of the source. The amplitude of the source is decreased in 10 dB steps and the analyzer marker functions are used to measure the amplitude difference between steps. The source's internal attenuator is used as the reference standard. The test is performed in both log and linear amplitude scales.

### Equipment

- Synthesizer/Level Generator ..... HP 3335A
- Step Attenuator, 1 dB steps ..... HP 355C
- Step Attenuator, 10 dB steps ..... HP 355D

#### Cables

- BNC Cable 122 cm (48 in) (2 required) ..... HP 10503A

#### Adapter

- Type N (m) to BNC (f) ..... 1250-1476
- Type BNC (m) to BNC (m) ..... 1250-0216

### Additional Equipment for Option 001

- Minimum Loss Adapter ..... HP 11852B
- Adapter Type N (f) to BNC (m), 75Ω ..... 1250-1534

## Procedure

## Log Scale

1. Set the HP 3335A controls as follows:

FREQUENCY ..... 50 MHz  
 AMPLITUDE ..... +10 dBm  
 AMPTD INCR ..... 0.05 dB  
 OUTPUT ..... 50Ω

2. Connect the equipment as shown in Figure 3-8. Set the HP 355D to 10 dB attenuation and the 355C to 0 dB attenuation.

*Option 001 only:* Set the attenuation of the HP 355D to 0 dB. Connect the minimum loss pad to the INPUT 75Ω using adapters.

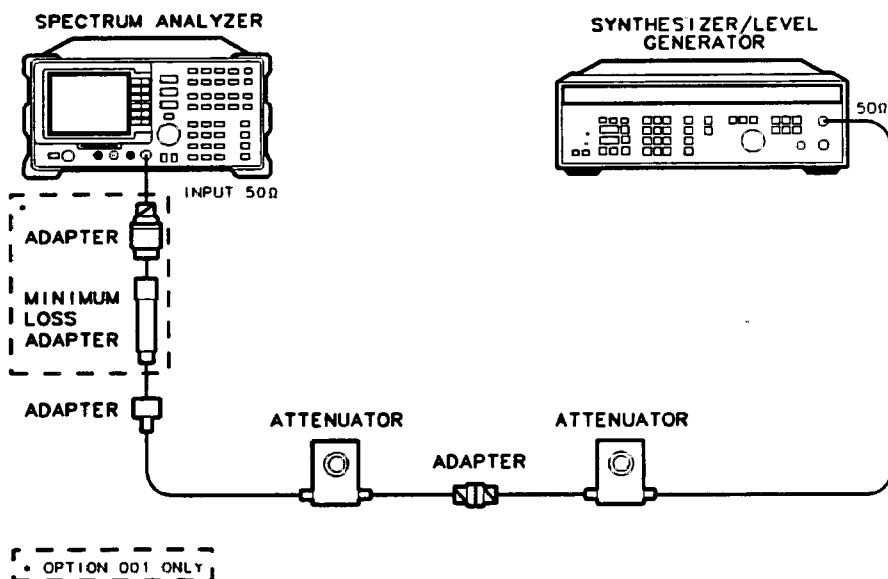

Figure 3-8. Scale Fidelity Test Setup

3. Press **PRESET** on the analyzer and wait for the preset to finish. Set the controls as follows:

CENTER FREQUENCY ..... 50 MHz  
 SPAN ..... 10 MHz

*(Option 001 only: Press **AMPLITUDE**, MORE 1 of 2, AMPTD UNITS, dBm.)*

4. On the analyzer, press the following keys:

**PEAK SEARCH** **SIGNAL TRACK** (ON)  
**SPAN** 50 **kHz**.

## 8. Scale Fidelity

After the auto zoom procedure is finished, set the resolution bandwidth to 3 kHz and the video bandwidth to 30 Hz.

5. If necessary, adjust the HP 355C attenuation until the MKR amplitude reads between 0 dBm and -1 dBm.
6. On the HP 3335A, press **AMPLITUDE** and use the INCR keys to adjust the amplitude until the analyzer MKR amplitude reads 0 dBm  $\pm 0.05$  dB.

### Note



It may be necessary to decrease the resolution of the amplitude increment of the HP 3335A to 0.01 dB to obtain a MKR reading of 0 dBm  $\pm 0.05$  dB.

7. On the analyzer, press **PEAK SEARCH**, **MARKER DELTA**.
8. Set the HP 3335A AMPTD INCR to 2 dB.
9. On the HP 3335A, press **AMPLITUDE** and **INCR** (down) to step the HP 3335A to the next lowest nominal amplitude listed in Table 3-9. Record the MKR  $\Delta$  amplitude reading in Table 3-9. The MKR amplitude should be within the limits shown.
10. Repeat step 9 for the remaining HP 3335A Nominal Amplitudes listed in Table 3-9.
11. For each MKR  $\Delta$  reading, subtract the previous MKR  $\Delta$  reading. Add 2 dB to the number and record the result as the incremental error in Table 3-9. The incremental error should not exceed 0.2 dB/2 dB.

**Table 3-9. Incremental Error, Log Mode**

HP 3335A Nominal Amplitude	dB from Ref Level (nominal)	MKR $\Delta$ Reading			Incremental Error (dB)
		Min (dB)	Actual (dB)	Max (dB)	
+10 dBm	0	0 (Ref)	0 (Ref)	0 (Ref)	0 (Ref)
+8 dBm	-2	-2.2	_____	-1.8	_____
+6 dBm	-4	-4.4	_____	-3.6	_____
+4 dBm	-6	-6.6	_____	-5.4	_____
+2 dBm	-8	-8.75	_____	-7.25	_____
0 dBm	-10	-10.75	_____	-9.25	_____

### Scale Fidelity, Log Mode

12. Set the HP 3335A AMPTD INCR to 10 dB.
13. On the HP 3335A, press **INCR** (up).
14. One the HP 3335A, press **INCR** (down) to step the HP 3335A to the next lowest nominal amplitude listed in Table 3-10. Record the MKR  $\Delta$  amplitude reading in Table 3-10. The MKR amplitude should be within the limits shown.

15. Repeat step 14 for the remaining HP 3335A Nominal Amplitudes listed in Table 3-10.

**Table 3-10. Scale Fidelity, Log Mode**

HP 3335A Nominal Amplitude	dB From Ref Level (nominal)	MKR Δ Reading		
		Min (db)	Actual (dB)	Max (dB)
+10 dBm	0	0 (Ref)	0 (Ref)	0 (Ref)
0 dBm	-10	-10.75	_____	-9.25
-10 dBm	-20	-20.75	_____	-19.25
-20 dBm	-30	-30.75	_____	-29.25
-30 dBm	-40	-40.75	_____	-39.25
-40 dBm	-50	-50.75	_____	-49.25
-50 dBm	-60	-60.75	_____	-59.25
-60 dBm	-70	-71.00	_____	-69.00

**Linear Scale**

16. Set the HP 3335A controls as follows:

AMPLITUDE ..... +10 dBm  
 AMPTD INCR ..... 0.05 dB

17. Set the 355C to 0 dB attenuation.

18. Press **PRESET** on the analyzer and wait for the preset to finish. Press **AMPLITUDE**, **SCALE LOG LIN (LIN)**.

*Option 001 only:* Press **MORE 1 of 2, INPUT Z 50 75 (50)**.

Set the controls as follows:

FREQUENCY ..... 50 MHz  
 SPAN ..... 10 MHz

19. On the analyzer, press the following keys:

**PEAK SEARCH** **SIGNAL TRACK** (ON)  
**SPAN** 50 **kHz**.

After the auto zoom procedure is finished, set the resolution bandwidth to 3 kHz and video bandwidth to 30 Hz.

20. If necessary, adjust the HP 355C attenuation until the MKR reads approximately 223.6 mV.

## 8. Scale Fidelity

### Note



It may be necessary to decrease the resolution of the amplitude increment of the HP 3335A to 0.01 dB to obtain a MKR reading of 223.6 mV  $\pm$  0.4 mV.

21. On the HP 3335A, press **AMPLITUDE** and use the INCR keys to adjust the amplitude until the analyzer MKR amplitude reads 223.6 mV  $\pm$ 0.4 mV.
22. On the analyzer, press **PEAK SEARCH**.
23. Set the HP 3335A amplitude increment to 3 dB.
24. On the HP 3335A, press **AMPLITUDE** and **INCR ▾** (step-down key) to step the HP 3335A to the next lowest Nominal Amplitude listed in Table 3-11.

Record the MKR amplitude reading in Table 3-11. The MKR amplitude should be within the limits shown.

25. Repeat step 9 for the remaining HP 3335A Nominal Amplitudes listed in Table 3-11.

**Table 3-11. Scale Fidelity, Linear Mode**

HP 3335A Nominal Amplitude	% of Ref Level (nominal)	MKR Reading		
		Min (mV)	Actual (mV)	Max (mV)
+10 dBm	100	0 (Ref)	0 (Ref)	0 (Ref)
+7 dBm	70.7	150.98	_____	165.20
+4 dBm	50	104.69	_____	118.91
+1 dBm	35.48	72.22	_____	86.44
-2 dBm	25	48.79	_____	63.01

### Log to Linear Switching

26. Set the HP 355D to 10 dB attenuation and the HP 355C to 0 dB attenuation.
27. Set the synthesizer controls as follows:
  - FREQUENCY ..... 50 MHz
  - AMPLITUDE ..... +6 dBm
28. On the spectrum analyzer, press **PRESET** and wait for the preset to complete. Set the control as follows:
  - CENTER FREQ ..... 50 MHz
  - SPAN ..... 10 MHz
  - RES BW ..... 300 kHz
29. On the spectrum analyzer, press **PEAK SEARCH**, **MKR ->**, MKR -> REF LVL ,  
**PEAK SEARCH**, MARKER DELTA .

## 8. Scale Fidelity

30. Press **AMPLITUDE**, **SCALE LOG LIN (LIN)**, **MORE 1 of 2**, **AMPTD UNITS**, **dBm** to change the scale to linear and set the amplitude units to dBm.
31. If the MKR  $\Delta$  amplitude is less than 0 dB, record the MKR  $\Delta$  amplitude reading here. The absolute value of the reading should be less than 0.25 dB. If the MKR  $\Delta$  amplitude is greater than 0 dB, continue with step 32 below.

Log-to-Lin Switching Uncertainty \_\_\_\_\_ dB

32. Press **MKR ->**, **MKR -> REF LVL**, **PEAK SEARCH**, and **MARKER DELTA**.
33. Press **AMPLITUDE**, and **SCALE LOG LIN** to change the scale to LOG 10 dB/DIV.
34. Record the MKR  $\Delta$  amplitude reading here. The absolute value of the reading should be less than 0.25 dB.

Log-to-Lin Switching Uncertainty \_\_\_\_\_ dB

---

## 9. Input Attenuator Accuracy

### Specification

#### Range:

0 to 60 dB in 10 dB steps.

#### Accuracy:

20 to 50 dB,  $\pm 0.5$  dB at 50 MHz referred to 10 dB attenuation.

60 dB,  $\pm 0.75$  dB at 50 MHz referred to 10 dB attenuation.

### Description

The input attenuator's switching accuracy is tested over the full 0 dB to 60 dB range. Switching accuracy is referenced to the 10 dB attenuator setting. The attenuator in the synthesizer/level generator is used as the measurement standard.

### Equipment

Synthesizer/Level Generator ..... HP 3335A  
Step Attenuator, 1 dB steps ..... HP 355C  
Step Attenuator, 10 dB steps ..... HP 355D

#### Cables

BNC Cable, 120 cm (48 in) (2 required) ..... HP 10503A

#### Adapters

Type N (m) to BNC (f) ..... 1250-1476  
Type BNC (m) to BNC (m) ..... 1250-0216

### Additional Equipment for Option 001

Minimum Loss Adapter ..... HP 11852B  
Adapter Type N (f) to BNC (m), 75 $\Omega$  ..... 1250-1534

### Procedure

1. Connect the equipment as shown in Figure 3-9. Set the HP 355D to 20 dB attenuation and the HP 355C to 0 dB attenuation. *Option 001 only:* Connect the minimum loss adapter to the RF INPUT 75 $\Omega$  using adapters, and set the HP 355D to 10 dB attenuation.

2. Set the HP 3335A controls as follows:

FREQUENCY ..... 50 MHz  
AMPLITUDE ..... -50 dBm  
AMPTD INCR ..... 10 dB  
OUTPUT ..... 50 $\Omega$

## 9. Input Attenuator Accuracy

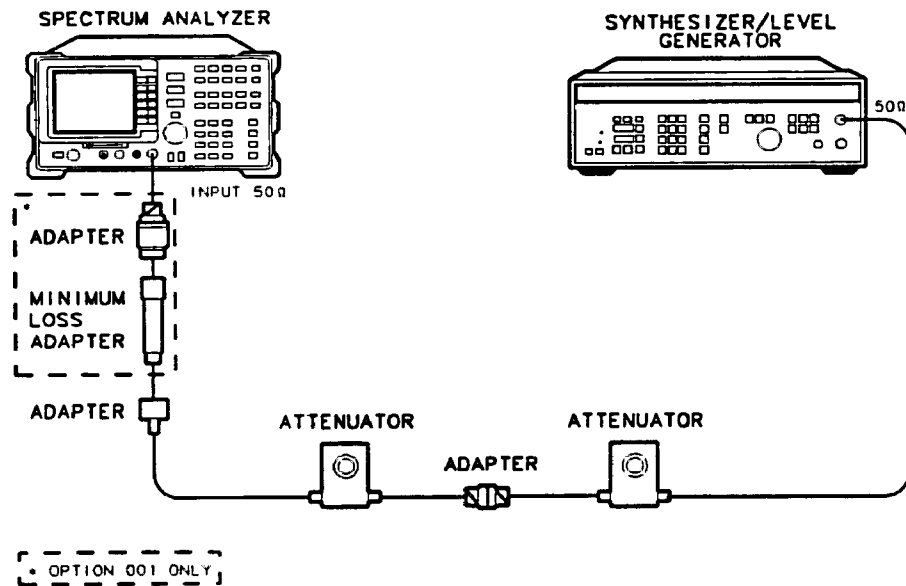

Figure 3-9. Input Attenuator Accuracy Test Setup

- On the analyzer, press **PRESET** and wait for the preset to finish. Set the controls as follows:

(Option 001 only: Press **AMPLITUDE**, **MORE 1 of 2**, **AMPTD UNITS**, **dBm**.)

CENTER FREQUENCY .....	50 MHz
SPAN .....	10 MHz
REF LEVEL .....	-70 dBm
LOG dB/DIV .....	1 dB
RES BW .....	10 kHz

- On the analyzer, press **PEAK SEARCH**, **SIGNAL TRACK** (ON), **SPAN**, 100 **kHz**. Set the video bandwidth to 100 Hz.
- Set the HP 355C attenuation to place the signal peak two to three dB (two to three divisions) below the reference level.
- On the analyzer, press the following keys:  
**SGL SWP** **PEAK SEARCH** **MARKER DELTA**.
- Set the HP 3335A amplitude to -60 dBm as indicated in row 2 of Table 3-12.
- On the analyzer, press **SGL SWP**, and wait for a new sweep to finish. Press **PEAK SEARCH** and record the MKR  $\Delta$  amplitude in Table 3-12 as the Actual MKR  $\Delta$  Reading. The MKR  $\Delta$  amplitude reading should be within the limits shown.
- Repeat step 8 using the HP 3335A amplitude and HP 8591A reference level and attenuation settings listed in Table 3-12.



## 9. Input Attenuator Accuracy

**Table 3-12. Input Attenuator Accuracy**

HP 3335A Amplitude (dBm)	HP 8591A Reference Level (dBm)	HP 8591A Attenuation (dB)	MKR $\Delta$ Min (dB)	MKR $\Delta$ Actual (dB)	MKR $\Delta$ Max (dB)
-50	-70	10	0 (Ref)	0 (Ref)	0 (Ref)
-40	-60	20	-0.5	_____	+0.5
-30	-50	30	-0.5	_____	+0.5
-20	-40	40	-0.5	_____	+0.5
-10	-30	50	-0.5	_____	+0.5
0	-20	60	-0.75	_____	+0.75

## 10. Reference Level Accuracy

### Specification

Accuracy referred to  $-20$  dBm reference level:

- 0 to  $-59.9$  dBm  $\pm(0.5$  dB + input attenuator accuracy at 50 MHz).
- $-60$  to  $-115$  dBm  $\pm(1.25$  dB + input attenuator accuracy at 50 MHz).

### Related Adjustment

A12 Cal Attenuator Error Correction.

### Description

A 50 MHz CW signal is applied to the INPUT  $50\Omega$  of the analyzer through two step attenuators. The attenuators increase the effective amplitude range of the source. The amplitude of the source is decreased in 10 dB steps and the analyzer marker functions are used to measure the amplitude difference between steps. The source's internal attenuator is used as the reference standard. The test is performed in both log and linear amplitude scales.

It is only necessary to test reference levels as low as  $-90$  dBm (with 10 dB attenuation) since lower reference levels are a function of the analyzer's microprocessor manipulating the trace data. There is no error associated with the trace data manipulation.

### Equipment

Synthesizer/Level Generator .....	HP 3335A
Step Attenuator, 1 dB steps .....	HP 355C
Step Attenuator, 10 dB steps .....	HP 355D

#### Cables

BNC Cable 122 cm (48 in)(2 required) .....	HP 10503A
--	-----------

#### Adapter

Type N (m) to BNC (f) .....	1250-1476
Type BNC (m) to BNC (m) .....	1250-0216

### Additional Equipment for Option 001

Minimum Loss Adapter .....	HP 11852B
Adapter Type N (f) to BNC (m), $75\Omega$ .....	1250-1534

## 10. Reference Level Accuracy

### Procedure

#### Log Scale

1. Set the HP 3335A controls as follows:

FREQUENCY ..... 50 MHz  
AMPLITUDE ..... -10 dBm  
AMPTD INCR ..... 10 dB  
OUTPUT ..... 50Ω

2. Connect the equipment as shown in Figure 3-10. Set the HP 355D to 10 dB attenuation and the 355C to 0 dB attenuation.  
*Option 001 only:* Connect the minimum loss adapter to the RF input 75Ω, using adapters and set the HP 355D to 0 dB attenuation.

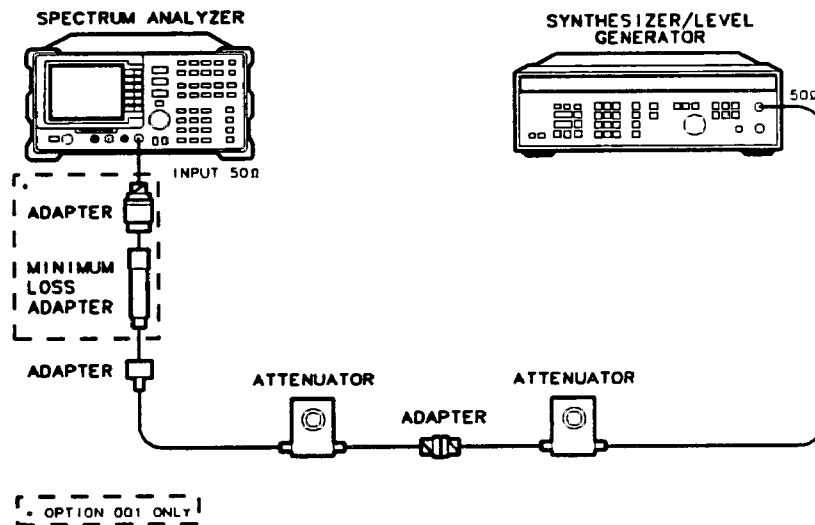

Figure 3-10. Reference Level Accuracy Test Setup

3. Press **PRESET** on the analyzer and wait for the preset to finish. Set the controls as follows:

CENTER FREQUENCY ..... 50 MHz  
SPAN ..... 10 MHz

- Press **PEAK SEARCH**. Set the controls as follows:

SIGNAL TRACK ..... ON  
SPAN ..... 50 kHz

*Option 001 only:* Press **AMPLITUDE**, MORE 1 of 2, AMPTD UNITS, dBm.

## 10. Reference Level Accuracy

Set the controls as follows:

REF LEVEL ..... -20 dBm  
 LOG dB/DIV ..... 1 dB  
 RES BW ..... 3 kHz  
 VIDEO BW ..... 30 Hz

4. Set the HP 355C attenuation to place the signal peak one to two dB (one to two divisions) below the reference level.
5. On the analyzer, press the following keys:  
  
 MARKER DELTA .
6. Set the HP 3335A amplitude and HP 8591A reference level according to Table 3-13. At each setting, press ,  on the analyzer. Record the MKR  $\Delta$  amplitude reading in Table 3-13. The MKR  $\Delta$  reading should be within the limits shown.

**Table 3-13. Reference Level Accuracy, Log Mode**

HP 3335A Amplitude	HP 8591A Reference Level	MKR $\Delta$ Reading		
		Min (dB)	Actual (dB)	Max (dB)
-10	-20	0 (Ref)	0 (Ref)	0 (Ref)
0	-10	-0.5	_____	+0.5
+10	0	-0.5	_____	+0.5
-20	-30	-0.5	_____	+0.5
-30	-40	-0.5	_____	+0.5
-40	-50	-0.5	_____	+0.5
-50	-60	-1.25	_____	+1.25
-60	-70	-1.25	_____	+1.25
-70	-80	-1.25	_____	+1.25
-80	-90	-1.25	_____	+1.25

### Linear Scale

7. Set the HP 3335A amplitude to -10 dBm.
8. Set the 355C to 0 dB attenuation.

**10. Reference Level Accuracy**

9. Set the analyzer controls as follows:

REF LEVEL ..... -20 dBm  
 AMPLITUDE SCALE ..... LINEAR

Press the following analyzer keys:

**AMPLITUDE** MORE 1 of 2 AMPTD UNITS dBm

**SWEEP** SWEEP CONT SGL (CONT).

Press **MKR**, MARKERS OFF.

10. Set the HP 355C attenuation to place the signal peak one to two divisions below the reference level.

11. On the analyzer, press **SGL SWP**, **PEAK SEARCH**, **MARKER DELTA**.

12. Set the HP 3335A amplitude and analyzer reference level according to Table 3-14. At each setting, press **SGL SWP**, **PEAK SEARCH** on the analyzer. Record the MKR Δ amplitude reading in Table 3-14. The MKR Δ reading should be within the limits shown.

**Table 3-14. Reference Level Accuracy, Linear Mode**

HP 3335A Amplitude (dBm)	HP 8591A Reference Level (dBm)	MKR Δ Reading		
		Min (dB)	Actual (dB)	Max (dB)
-10	-20	0 (Ref)	0 (Ref)	0 (Ref)
0	-10	-0.5	_____	+0.5
+10	0	-0.5	_____	+0.5
-20	-30	-0.5	_____	+0.5
-30	-40	-0.5	_____	+0.5
-40	-50	-0.5	_____	+0.5
-50	-60	-1.25	_____	+1.25
-60	-70	-1.25	_____	+1.25
-70	-80	-1.25	_____	+1.25
-80	-90	-1.25	_____	+1.25

13. In Table 3-13, locate the Actual MKR Δ Amplitude Reading for the 0 to -50 dBm reference level settings with the greatest deviation (positive or negative) from 0 dB and record below.

Log Mode Reference Level Accuracy \_\_\_\_\_ dB  
 (0 to -50 dBm reference level settings)

## 10. Reference Level Accuracy

14. In Table 3-13, locate the Actual MKR  $\Delta$  Amplitude Reading for the 0 to -90 dBm reference level settings with the greatest deviation (positive or negative) from 0 dB and record below.

Log Mode Reference Level Accuracy \_\_\_\_\_ dB  
(0 to -90 dBm reference level settings)

15. In Table 3-14, locate the Actual MKR  $\Delta$  Amplitude Reading for the 0 to -50 dBm reference level settings with the greatest deviation (positive or negative) from 0 dB and record below.

Linear Mode Reference Level Accuracy \_\_\_\_\_ dB  
(0 to -50 dBm reference level settings)

16. In Table 3-14, locate the Actual MKR  $\Delta$  Amplitude Reading for the 0 to -90 dBm reference level settings with the greatest deviation (positive or negative) from 0 dB and record below.

Linear Mode Reference Level Accuracy \_\_\_\_\_ dB  
(0 to -90 dBm reference level settings)

---

## 11. Resolution Bandwidth Switching Uncertainty

### Specification

$\pm 0.4$  dB for 3 kHz to 3 MHz RES BW settings, referred to 3 kHz RES BW setting.

$\pm 0.5$  dB for 1 kHz to 3 MHz RES BW settings, referred to 3 kHz RES BW setting.

### Related Adjustments

Crystal and LC Bandwidth Adjustment.

### Description

For this test, the CAL OUT signal is used as the input signal. An amplitude reference is taken with the RES BW set to 1 kHz using the marker delta function. The RES BW is changed to settings between 3 MHz and 1 kHz and the amplitude variation is measured at each setting and compared to the specification. The span is changed as necessary to maintain approximately the same aspect ratio.

### Equipment

#### Cable

BNC, 23 cm (9 in) ..... HP 10502A

#### Adapter

Type N (m) to BNC (f) ..... 1250-1476

### Additional Equipment for Option 001

BNC Cable, 75 $\Omega$ , 30 cm (12 in) ..... 5062-6452

### Procedure

1. Connect the CAL OUT to the spectrum analyzer input using the BNC cable and adapter, as shown in Figure 3-11. *Option 001:* Use the 75 $\Omega$  cable and omit the adapter.

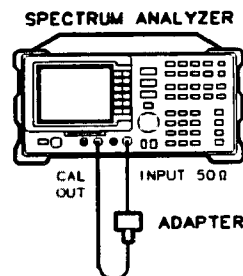

Figure 3-11. Resolution Bandwidth Switching Uncertainty Test Setup

## 11. Resolution Bandwidth Switching Uncertainty

2. Press **PRESET** on the analyzer and wait for the preset to finish. Set the controls as follows:

(Option 001 only: Press **AMPLITUDE**, MORE 1 of 2, AMPTD UNITS, dBm.)

CENTER FREQUENCY ..... 300 MHz  
 SPAN ..... 10 MHz

Press **PEAK SEARCH** and **SIGNAL TRACK** (ON).

Set the controls as follows:

SPAN ..... 50 kHz  
 REF LEVEL ..... -20 dBm  
 LOG dB/DIV ..... 1 dB  
 RES BW ..... 3 kHz  
 VIDEO BW ..... 1 kHz

3. Press **AMPLITUDE** and use the knob to adjust the REF LEVEL until the signal appears one division below the reference level. Press **PEAK SEARCH**, **MARKER DELTA**, **SIGNAL TRACK** (ON).
4. Set the resolution bandwidth and span according to Table 3-15.
5. Press **PEAK SEARCH**, then record the MKR Δ TRK amplitude reading in Table 3-15.  
 The amplitude reading should be within the limits shown.
6. Repeat steps 4 and 5 for each of the remaining resolution bandwidth and span settings listed in Table 3-15.

**Table 3-15. Resolution Bandwidth Switching Uncertainty**

RES BW Setting	Span Setting	MKR Δ TRK Amplitude Reading		
		Min (dB)	Actual (dB)	Max (dB)
3 kHz	50 kHz	0 (Ref)	0 (Ref)	0 (Ref)
1 kHz	50 kHz	-0.5	_____	+0.5
10 kHz	50 kHz	-0.4	_____	+0.4
30 kHz	500 kHz	-0.4	_____	+0.4
100 kHz	500 kHz	-0.4	_____	+0.4
300 kHz	5 MHz	-0.4	_____	+0.4
1 MHz	10 MHz	-0.4	_____	+0.4
3 MHz	10 MHz	-0.4	_____	+0.4



---

## 12. Calibrator Amplitude Accuracy

### Specification

Amplitude:

-20 dBm  $\pm$ 0.4 dB (*Option 001*: +28.75 dBmV  $\pm$ 0.4 dB).

### Related Adjustment

Calibrator Amplitude Adjustment.

### Description

This test measures the accuracy of the analyzer's CAL OUT signal. The first part of the test characterizes the insertion loss of a Low Pass Filter (LPF) and 10 dB Attenuator. The harmonics of the CAL OUT signal are suppressed with the LPF before the amplitude accuracy is measured using a power meter.

Calibrator Frequency is not included in this procedure because it is a function of the Frequency Reference (CAL OUT Frequency = 300 MHz  $\pm$ (300 MHz  $\times$  Frequency Reference)). Perform the Frequency Reference Accuracy test to verify the CAL OUT frequency.

### Equipment

Synthesized Sweeper .....	HP 8340A/B
Measuring Receiver (used as a power meter) .....	HP 8902A
Power Meter .....	HP 436A
Low Power Sensor with a 50 MHz reference attenuator .....	HP 8484A
Power Sensor .....	HP 8482A
Power Splitter .....	HP 11667A
10 dB Attenuator, Type N (m to f), dc-12.4 GHz Opt 010.....	HP 8491A
Low Pass Filter .....	0955-0455

### Cables

Type N, 152 cm (60 in) .....	HP 11500D
------------------------------	-----------

### Adapters

APC 3.5 (f) to Type N (f) .....	1250-1745
Type N (f) to BNC (m) (2 required) .....	1250-1477
Type N (m) to BNC (f) .....	1250-1476

### Additional Equipment for Option 001

Minimum Loss Adapter .....	HP 11852B
Mechanical Adapter, 75 $\Omega$ to 50 $\Omega$ .....	1250-0597
Adapter, Type N (f) 75 $\Omega$ to BNC (m) 75 $\Omega$ .....	1250-1534

**Procedure**

**LPF, Attenuator and Adapter Insertion Loss Characterization**

1. Zero and calibrate the HP 8902A and HP 8482A in LOG mode as described in the *HP 8902A Operation Manual*.
2. Zero and calibrate the HP 436A and HP 8484A, as described in the *HP 436A Operation Manual*.

**Caution**



Do not attempt to calibrate the HP 8484A without the reference attenuator or damage to the HP 8484A will occur.

3. Press **INSTR PRESET** on the HP 8340A/B. Set the controls as follows:

CW ..... 300 MHz  
 POWER LEVEL ..... -15 dBm

4. Connect the equipment as shown in Figure 3-12. Connect the HP 8484A directly to the power splitter (bypass the LPF, attenuator, and adapters).

**Note**



Allow the power sensors to settle before proceeding.

5. On the HP 8902A, press **RATIO** mode. Power indication should be zero dB.
6. On the HP 436A, press the dB REF mode key. Power indication should be zero dB.
7. Connect the LPF, attenuator and adapters as shown in Figure 3-12.
8. Record the HP 8902A reading in dB. This is the relative error due to mismatch.

Mismatch Error \_\_\_\_\_dB

9. Record the HP 436A reading in dB. This is the relative uncorrected insertion loss of the LPF, attenuator and adapters.

Uncorrected Insertion Loss \_\_\_\_\_ dB

## 12. Calibrator Amplitude Accuracy

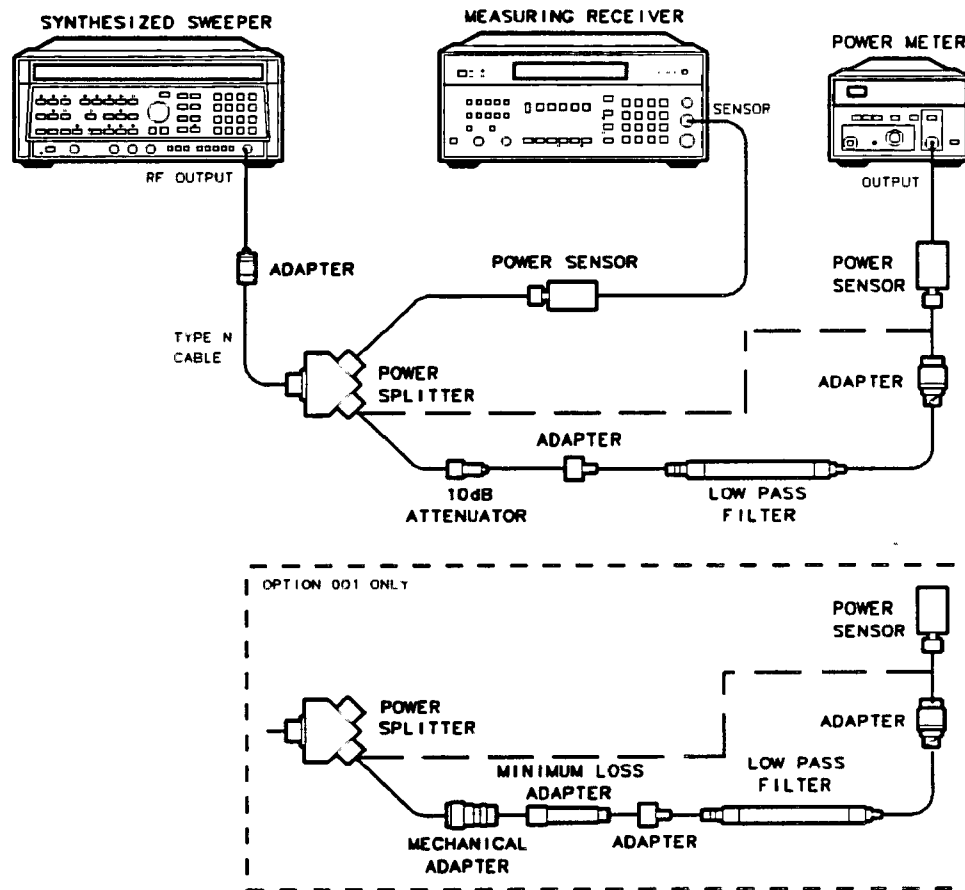

Figure 3-12. LPF Characterization

- Subtract the Mismatch Error (step 8) from the Uncorrected Insertion Loss (step 9). This is the corrected insertion loss.

Corrected Insertion Loss \_\_\_\_\_ dB

Example: If the Mismatch Error is +0.3 dB and the Uncorrected Insertion Loss is -10.2 dB, subtract the mismatch error from the insertion loss to yield a corrected reading of -10.5 dB.

### Calibrator Amplitude Accuracy

- Connect the equipment as shown in Figure 3-13. The analyzer should be positioned so that the setup of the adapters, LPF and attenuator do not bind. It may be necessary to support the center of gravity of the devices.

## 12. Calibrator Amplitude Accuracy

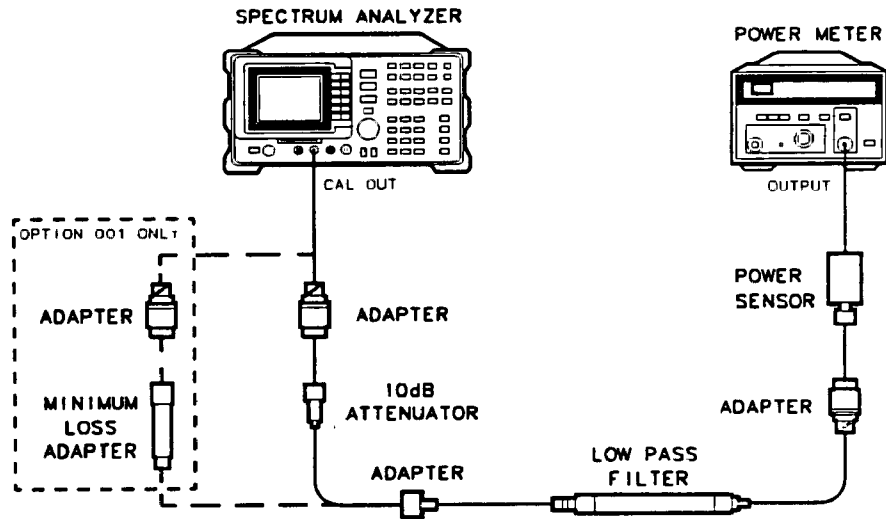

Figure 3-13. Calibrator Amplitude Accuracy Test Setup

12. On the HP 436A, press the dBm mode key. Record the HP 436A Reading in dBm.

HP 436A Reading \_\_\_\_\_ dBm

13. Subtract the Corrected Insertion Loss (step 10) from the HP 436A Reading (step 12) and record as the CAL OUT power. The CAL OUT should be  $-20 \text{ dBm} \pm 0.4 \text{ dB}$ .

$$\text{CAL OUT Power} = \text{HP 436A Reading} - \text{Corrected Insertion Loss}$$

Example: If the Corrected Insertion Loss is  $-10.0 \text{ dB}$ , and the HP 8902A reading is  $-30 \text{ dB}$ , then  $(-30 \text{ dB}) - (-10.0 \text{ dB}) = -20 \text{ dB}$

CAL OUT Power \_\_\_\_\_ dBm

*Option 001 only:* The CAL OUT power measured on  $75\Omega$  instruments will be the same as  $50\Omega$  instruments. To convert from dBm to dBmV use the following equation.

$$\text{dBmV} = \text{dBm} + 48.75 \text{ dB}$$

Example:  $-20 + 48.75 = 28.75 \text{ dBmV}$

CAL OUT Power \_\_\_\_\_ dBmV

---

## 13. Frequency Response

### Specification

With 10 dB INPUT ATTEN setting:

Absolute referred to 300 MHz  
9 kHz to 1.8 GHz (*Option 001*: 1 MHz to 1.8 GHz)  $<\pm 1.5$  dB.

Relative flatness referred to midpoint between maximum and minimum peak excursions:  
9 kHz to 1.8 GHz (*Option 001*: 1 MHz to 1.8 GHz)  $<\pm 1.0$  dB.

### Related Adjustment

Frequency Response Error Correction.

### Description

The output of the synthesized sweeper is fed through a power splitter to a power sensor and the analyzer. The synthesized sweeper's power level is adjusted at 300 MHz to place the displayed signal at the analyzer's center horizontal graticule line. The measuring receiver, used as a power meter, is placed in **RATIO** mode. At each new sweeper frequency and analyzer center frequency setting, the sweeper's power level is adjusted to place the signal at the center horizontal graticule line. The measuring receiver displays the inverse of the frequency response relative to 300 MHz (**CAL OUT** frequency).

Testing the flatness of *Option 001*, **INPUT 75 $\Omega$** , is accomplished by first characterizing the system flatness.

### Equipment

Synthesized Sweeper .....	HP 8340A/B
Measuring Receiver (used as a power meter) .....	HP 8902A
Frequency Synthesizer .....	HP 3335A
Power Sensor .....	HP 8482A
Power Splitter .....	HP 11667A

### Adapters

Type N (f) to APC 3.5 (f) .....	1250-1745
Type N (m) to Type N (m) .....	1250-1475

### Cables

BNC, 122 cm (48 in) .....	HP 10503A
Type N, 183 cm (72 in) .....	HP 11500A

**Additional Equipment for Option 001**

Power Meter .....	HP 436A
Power Sensor .....	HP 8483A
Cable, BNC, 120 cm (48 in) 75Ω .....	15525-80010
Adapter, Type N (f) 75Ω to Type N (m) 50Ω .....	1250-0597
Adapter Type N (m) to BNC (m), 75Ω .....	1250-1533

**Procedure for System Characterization, Option 001 Only**

1. Zero and calibrate the HP 8902A and HP 8482A as described in the *HP 8902A Operation Manual*.
2. Zero and calibrate the HP 436A and the HP 8483A as described in the *HP 436A Operation Manual*.
3. Press **INSTR PRESET** on the HP 8340A/B. Set the HP 8340A/B controls as follows:
 

CW .....	50 MHz
FREQ STEP .....	50 MHz
POWER LEVEL .....	5 dBm
4. Connect the equipment as shown in Figure 3-14.

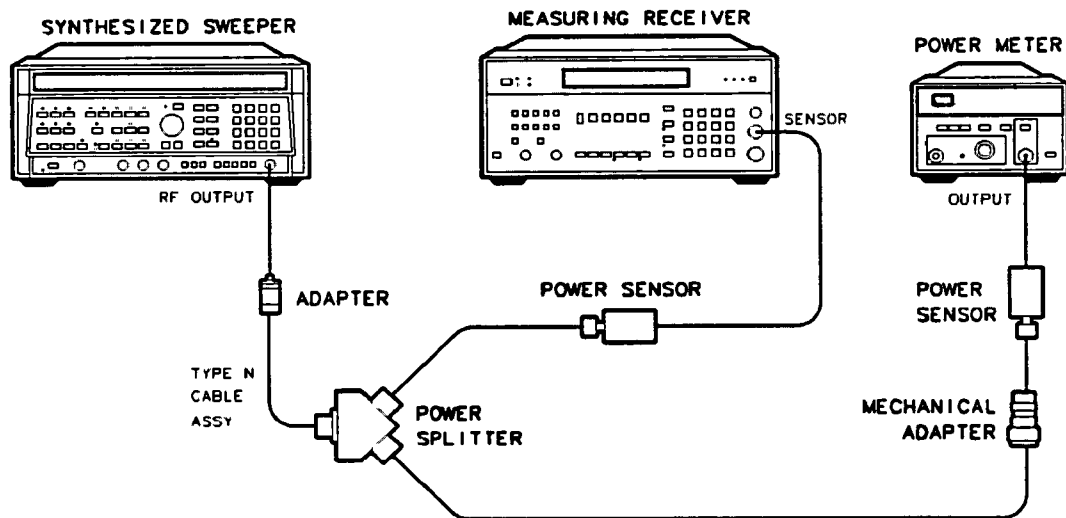

**Figure 3-14. System Characterization Test Setup (Option 001)**

5. Adjust the HP 8340A/B power level for a 0 dBm reading on the HP 8902A.
6. Record the HP 436A reading in Column 4 of Table 3-16, taking into account the Cal Factors of both the HP 8482A and the HP 8483A.
7. On the HP 8340A/B, press **CW**, and **▲** (step-up key), to step through the remaining frequencies listed in Table 3-16.

At each new frequency repeat steps 5 and 6, entering each power sensor's Cal Factor into the respective power meter.

### 13. Frequency Response

#### Procedure

1. Zero and calibrate the HP 8902A and HP 8482A in log mode as described in the *HP 8902A Operation Manual*.
2. Connect the equipment as shown in Figure 3-15. *Option 001 only*: Refer to Figure 3-16.

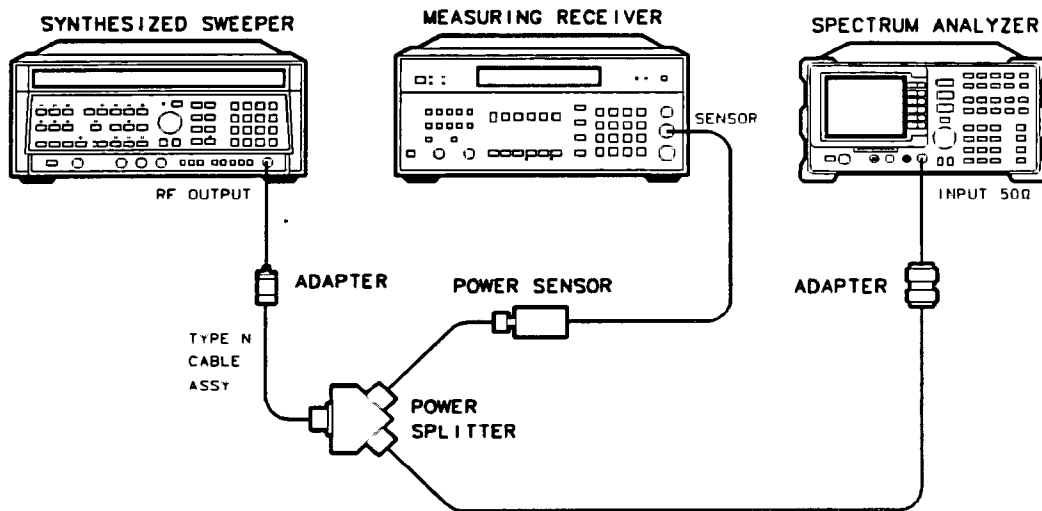

Figure 3-15. Frequency Response Test Setup,  $\geq 50$  MHz

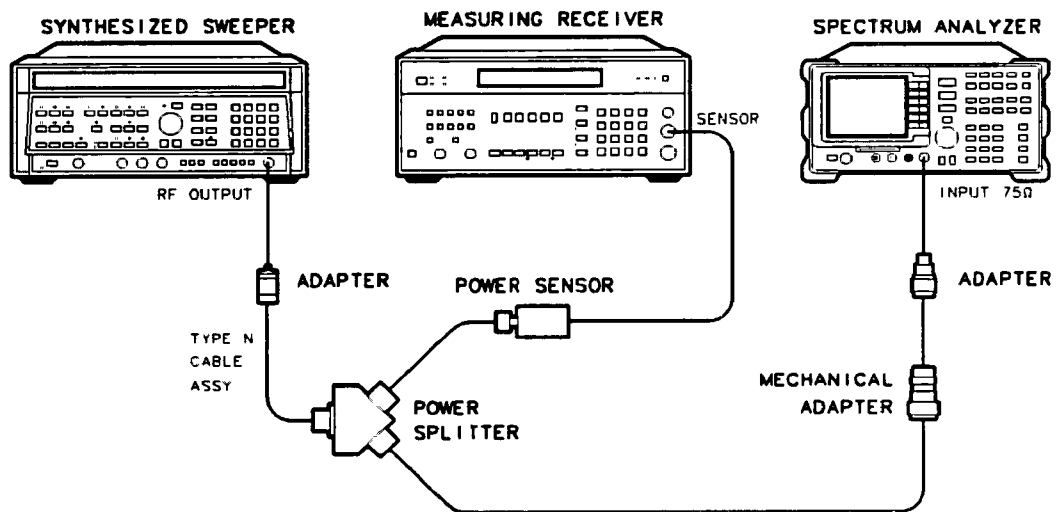

Figure 3-16. Frequency Response Test Setup,  $\geq 50$  MHz, for Option 001

3. Press **INSTR PRESET** on the HP 8340A/B. Set the HP 8340A/B controls as follows:
 

CW .....	300 MHz
FREQ STEP .....	50 MHz
POWER LEVEL .....	-8 dBm

### 13. Frequency Response

4. On the analyzer, press **PRESET** and wait for the preset to finish. Press **FREQUENCY**. Set the analyzer's controls as follows:

CENTER FREQUENCY ..... 300 MHz  
CF STEP ..... 50 MHz  
SPAN ..... 5 MHz

(Option 001 only: Press **AMPLITUDE**, MORE 1 of 2, AMPTD UNITS, dBm).

REF LEVEL ..... -10 dBm  
LOG dB/DIV ..... 1 dB  
RES BW ..... 1 MHz  
VIDEO BW ..... 3 kHz

5. On the analyzer, press **PEAK SEARCH**, **SIGNAL TRACK** (ON).
6. Adjust the HP 8340A/B power level for a MKR-TRK amplitude reading of -14 dBm  $\pm$ 0.05 dB.
7. Set the sensor Cal Factor on the HP 8902A and then press **RATIO** on the HP 8902A.
8. Set the HP 8340A/B CW to 50 MHz.
9. Set the analyzer center frequency to 50 MHz.
10. Adjust the HP 8340A power level for an analyzer MKR-TRK amplitude reading of -14 dBm  $\pm$ 0.05 dB.
11. Set the sensor Cal Factor on the HP 8902A and record the negative of the power ratio here and in Table 3-16.

Negative of HP 8902A Reading at 50 MHz \_\_\_\_\_ dB

12. Set the HP 8340A/B CW to 100 MHz.
13. Set the analyzer center frequency to 100 MHz.
14. Adjust the HP 8340A/B power level for an analyzer MKR-TRK amplitude reading of -14 dBm  $\pm$ 0.05 dB.
15. Set the sensor Cal Factor on the HP 8902A and record the negative of the power ratio displayed on the HP 8902A in Table 3-16 as the Error Relative to 300 MHz.
16. On the HP 8340A/B, press **CW**, and **▲** (step-up key), and on the analyzer, press **FREQUENCY**, and **▲** (step-up key), to step through the remaining frequencies listed in Table 3-16. At each new frequency repeat steps 14 through 16, entering the power sensor's Cal Factor into the HP 8902A as indicated in Table 3-16.

#### Frequency Response, ( $\leq$ 50 MHz)

17. Using a cable, connect the HP 3335A directly to the INPUT 50 $\Omega$ . Refer to Figure 3-17.  
(Option 001: Using a 75 $\Omega$  cable, connect the HP 3335A from the 75 $\Omega$  OUTPUT to the INPUT 75 $\Omega$ . Set the HP 3335A 50-75 $\Omega$  switch to the 75 $\Omega$  position.)



### 13. Frequency Response

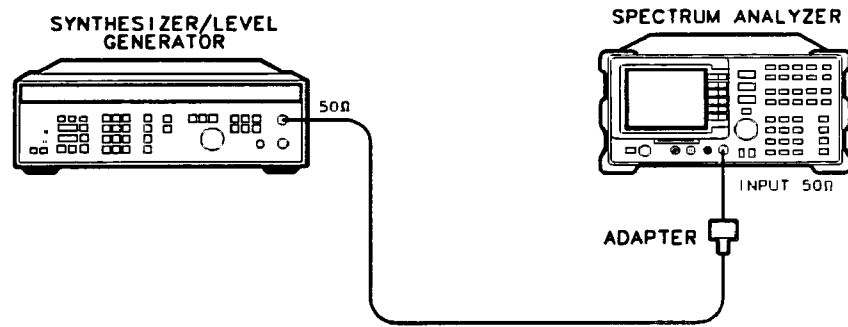

**Figure 3-17. Frequency Response Test Setup (<50 MHz)**

Set the HP 3335A controls as follows:

FREQUENCY ..... 50 MHz  
 AMPLITUDE ..... -15 dBm  
 AMPTD INCR ..... 0.05 dB

18. On the analyzer press the following keys:

**SPAN** 10 **MHz**  
**FREQUENCY** 50 **MHz**  
**BW** 3 **kHz**  
 VID BW AUTO MAN 1 **kHz**  
**SPAN** 100 **kHz**.

Wait for AUTO ZOOM to finish.

19. Adjust the HP 3335A amplitude until the MKR-TRK reads -14 dBm. This corresponds to the amplitude at 50 MHz recorded in step 11. Record the HP 3335A amplitude here.

HP 3335A Amplitude Setting (50 MHz) \_\_\_\_\_ dBm

20. On the analyzer, press **MARKER DELTA**, **SIGNAL TRACK** (ON).

21. Set the analyzer center frequency and the HP 3335A frequency to the frequencies listed in Table 3-17. At each frequency, adjust the HP 3335A amplitude for a MKR-Δ-TRK amplitude reading of  $0.00 \pm 0.05$  dB. Record the HP 3335A amplitude setting in Table 3-17 as the HP 3335A amplitude. (*Option 001*: Do not test below 1 MHz).

22. For each of the frequencies in Table 3-17, subtract the HP 3335A Amplitude Reading (column 2) from the HP 3335A amplitude setting (50 MHz) recorded in step 19. Record the result as the Response Relative to 50 MHz (column 3) of Table 3-17.

23. Add to each of the Response Relative to 50 MHz entries in Table 3-17 the HP 8902A Reading at 50 MHz recorded in step 11. Record the results as the Response Relative to 300 MHz (column 4) in Table 3-17.

### 13. Frequency Response

24. *Option 001*: Starting with the error at 50 MHz, subtract Column 4 (System Error) from Column 2 (Error Relative to 300 MHz) and record the result in Column 5 (Corrected Error Relative to 300 MHz).

#### Test Results

25. Frequency Response:

- a. Enter most positive number from Table 3-17, column 4: \_\_\_\_\_ dB
- b. Enter most positive number from Table 3-16, column 2: \_\_\_\_\_ dB  
(*Option 001*: Use column 5)
- c. Enter more positive of numbers from (a) and (b): \_\_\_\_\_ dB
- d. Enter the most negative number from Table 3-17, column 4: \_\_\_\_\_ dB
- e. Enter most negative number from Table 3-16, column 2: \_\_\_\_\_ dB  
(*Option 001*: Use column 5)
- f. Enter more negative of numbers from (d) and (e): \_\_\_\_\_ dB
- g. Subtract (f) from (c): \_\_\_\_\_ dB  
The result should be less than 2.0 dB.
- h. The absolute values in (c) and (f) should be less than 1.5 dB.

**13. Frequency Response**

**Table 3-16. Frequency Response Errors**

Column 1 Frequency (MHz)	Column 2 Error Relative to 300 MHz (dB)	Column 3 Sensor CAL FACTOR Frequency (GHz)	Column 4 (Option 001) System Error (dB)	Column 5 (Option 001) Corrected Error Relative to 300 MHz (dB)
50	_____	0.03	_____	_____
100	_____	0.1	_____	_____
150	_____	0.1	_____	_____
200	_____	0.3	_____	_____
250	_____	0.3	_____	_____
300 (Ref)	_____	0.3	_____	_____
350	_____	0.3	_____	_____
400	_____	0.3	_____	_____
450	_____	0.3	_____	_____
500	_____	0.3	_____	_____
550	_____	1.0	_____	_____
600	_____	1.0	_____	_____
650	_____	1.0	_____	_____
700	_____	1.0	_____	_____
750	_____	1.0	_____	_____
800	_____	1.0	_____	_____
850	_____	1.0	_____	_____
900	_____	1.0	_____	_____
950	_____	1.0	_____	_____
1000	_____	1.0	_____	_____
1050	_____	1.0	_____	_____
1100	_____	1.0	_____	_____
1150	_____	1.0	_____	_____
1200	_____	1.0	_____	_____
1250	_____	1.0	_____	_____
1300	_____	1.0	_____	_____

13. Frequency Response

Table 3-16. Frequency Response Errors (continued)

Column 1 Frequency (MHz)	Column 2 Error Relative to 300 MHz (dB)	Column 3 Sensor CAL FACTOR Frequency (GHz)	Column 4 (Option 001) System Error (dB)	Column 5 (Option 001) Corrected Error Relative to 300 MHz (dB)
1350	_____	1.0	_____	_____
1400	_____	1.0	_____	_____
1450	_____	1.0	_____	_____
1500	_____	1.0	_____	_____
1550	_____	2.0	_____	_____
1600	_____	2.0	_____	_____
1650	_____	2.0	_____	_____
1700	_____	2.0	_____	_____
1750	_____	2.0	_____	_____
1800	_____	2.0	_____	_____

Table 3-17. Frequency Response (<50 MHz)

Column 1 Frequency	Column 2 HP 3335A Amplitude (dBm)	Column 3 Response Relative to 50 MHz	Column 4 Response Relative to 300 MHz
50 MHz	_____	0 (Reference)	_____
20 MHz	_____	_____	_____
10 MHz	_____	_____	_____
5 MHz	_____	_____	_____
1 MHz	_____	_____	_____
200 kHz	_____	_____	_____
50 kHz	_____	_____	_____
9 kHz	_____	_____	_____

---

## 14. Spurious Response

### Specification

Second Harmonic Distortion:

< -70 dBc, 5 MHz to 1.8 GHz, for -45 dBm tone at input mixer.

Third Order Intermodulation Distortion:

< -70 dBc, 5 MHz to 1.8 GHz, for two -30 dBm tones at input mixer and >50 kHz signal separation.

### Description

This test is performed in two parts. The first part measures second harmonic distortion; the second part measures third order intermodulation distortion.

To test second harmonic distortion, a 50 MHz low pass filter is used to filter the source output, ensuring that harmonics read by the analyzer are internally generated and not coming from the source. To measure the distortion products, the power at the mixer is set 25 dB higher than specified. New test limits have been developed based on this higher power.

With -45 dBm at the input mixer and the distortion products suppressed by 70 dBc, the equivalent Second Order Intercept (SOI) is +25 dBm (-45 dBm + 70 dBc). Therefore, with -20 dBm at the mixer, and the distortion products suppressed by 45 dBc, the equivalent SOI is also +25 dBm (-20 dBm + 45 dBc).

For third order intermodulation distortion, two signals are combined in a directional bridge (for isolation) and are applied to the analyzer input. The power level of the two signals is 8 dB higher than specified, so the distortion products should be suppressed by 16 dB less than specified. In this manner, the equivalent Third Order Intercept (TOI) is measured.

With two -30 dBm signals at the input mixer and the distortion products suppressed by 70 dBc, the equivalent TOI is +5 dBm (-30 dBm + 70 dBc/2). However, if two -22 dBm signals are present at the input mixer and the distortion products are suppressed by 54 dBc, the equivalent TOI is also +5 dBm (-22 dBm + 54 dBc/2).

Performing the test with a higher power level maintains the measurement integrity while reducing both test time and the dependency upon the source's noise sideband performance.

### Equipment

Synthesizer/Level Generator .....	HP 3335A
Synthesized Sweeper .....	HP 8340A/B
Measuring Receiver (or Power Meter) .....	HP 8902A
Power Sensor, 100 kHz to 4.2 GHz .....	HP 8482A
50 MHz Low Pass Filter .....	0955-0306
Directional Bridge .....	HP 8721A

### Cables

BNC Cable, 120 cm (48 in) (2 required) .....	HP 10503A
--	-----------

**Adapters**

Type N (f) to APC 3.5 (f) .....	1250-1745
Type N (f) to BNC (m) .....	1250-1477
Type N (m) to BNC (f) .....	1250-1476
N (m) to BNC (m) .....	1250-1473

**Additional Equipment for Option 001**

Power Sensor .....	HP 8483A
Mechanical Adapter, 75Ω to 50Ω .....	1250-0597
Minimum Loss Adapter .....	HP 11852B
Adapter Type N (f) to BNC (m), 75Ω .....	1250-1534
BNC (m) to BNC (m) .....	1250-1288

**Procedure**

**Second Harmonic Distortion, 30 MHz**

- Set the HP 3335A controls as follows:
 

FREQUENCY .....	30 MHz
AMPLITUDE .....	-10 dBm
AMPLITUDE ( <i>Option 001</i> ) .....	-4.3 dBm
- Connect the equipment as shown in Figure 3-18. (*Option 001*: Connect the HP 11852B between the LPF and INPUT 75Ω).

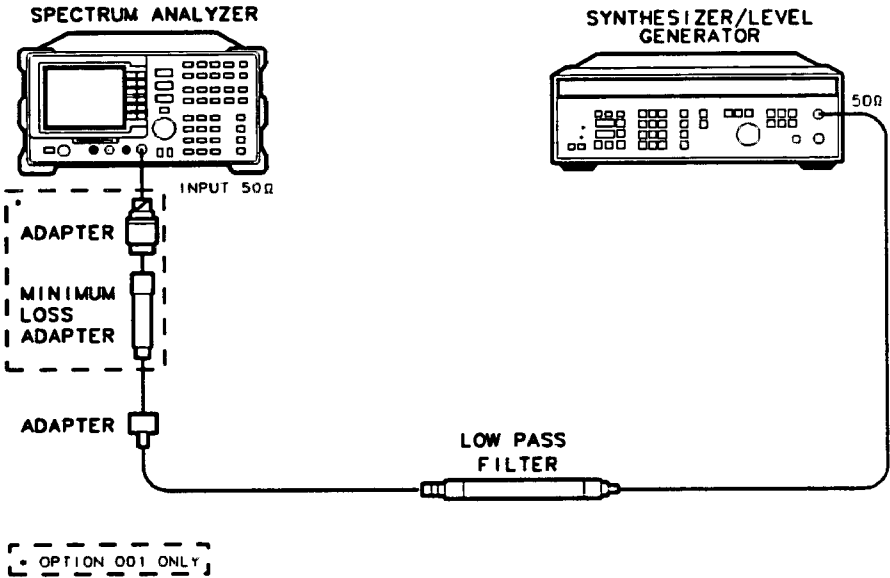

**Figure 3-18. Second Harmonic Distortion Test Setup, 30 MHz**

#### 14. Spurious Response

3. Press **PRESET** on the analyzer and wait for the preset to finish. Set the controls as follows:

CENTER FREQUENCY ..... 30 MHz  
SPAN ..... 10 MHz

(Option 001: Press **AMPLITUDE**, MORE 1 of 2, AMPTD UNITS, dBm).

REF LEVEL ..... -10 dBm

Press **PEAK SEARCH**, **SIGNAL TRACK** (ON), **SPAN** 1 **MHz**, **SIGNAL TRACK** (OFF), **BW**, 30 **kHz**.

4. Adjust the HP 3335A amplitude to place the peak of the signal at the reference level (-10 dBm).
5. Set the analyzer control as follows:

RES BW ..... 1 kHz  
VIDEO BW ..... 100 Hz

6. Wait for two sweeps to finish. On the analyzer, press **PEAK SEARCH**, **MKR ->**, **MKR -> CF STEP**, **MKR**, **MARKER DELTA**, **FREQUENCY**.
7. Press the **▲**, step-up key on the analyzer to step to the second harmonic (at 60 MHz). Press **PEAK SEARCH**. Record the MKR  $\Delta$  Amplitude reading:

MKR  $\Delta$  Amplitude Reading \_\_\_\_\_ < -45 dBc.

#### Third Order Intermodulation Distortion, 50 MHz

8. Zero and calibrate the HP 8902A and HP 8482A combination in log mode (RF Power readout in dBm). Enter the power sensor's 50 MHz Cal Factor into the HP 8902A.  
*Option 001:* Calibrate the HP 8483A 75 $\Omega$  power sensor.
9. Connect the equipment as shown in Figure 3-19 with the output of the directional bridge connected to the power sensor.  
*(Option 001: Use the HP 8483A Power Sensor with an 1250-1534 Type N (f) to BNC (m) 75 $\Omega$  adapter and use an 1250-1288 BNC (m) to BNC (m) 75 $\Omega$  adapter in place of the 50 $\Omega$  adapter.)*

---

#### Note



*For Option 001 only:* The power measured at the output of the 50 $\Omega$  directional bridge by the 75 $\Omega$  power sensor, is the equivalent power "seen" by the 75 $\Omega$  analyzer.

---

## 14. Spurious Response

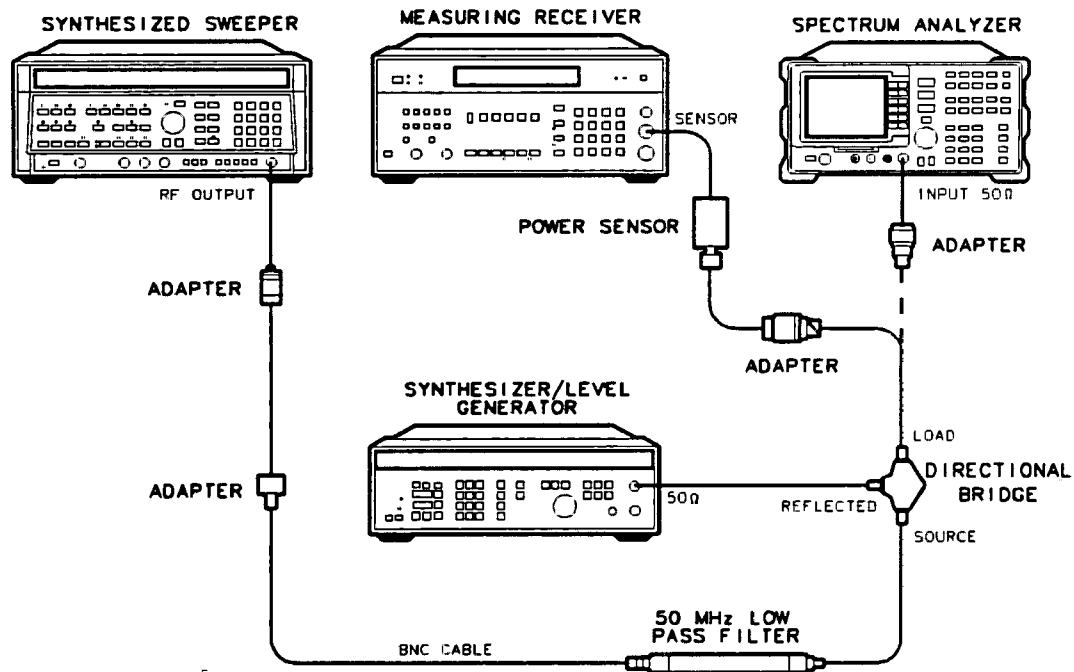

Figure 3-19. Third Order Intermodulation Distortion Test Setup

10. Press **INSTR PRESET** the HP 8340A/B. Set the HP 8340A/B controls as follows:

POWER LEVEL ..... -6 dBm  
 CW ..... 50 MHz  
 RF ..... OFF

11. Set the HP 3335A controls as follows:

FREQUENCY ..... 50.050 MHz  
 AMPLITUDE ..... -6 dBm  
 50Ω/75Ω switch ..... 75Ω (no RF output)

12. On the analyzer, press **PRESET** and wait until the preset is finished. Set the controls as follows:

CENTER FREQUENCY ..... 50 MHz  
 SPAN ..... 10 MHz

(Option 001: Press **AMPLITUDE**, MORE 1 of 2, AMPTD UNITS, dBm).

AMPLITUDE ..... -10 dBm

Press the following analyzer keys:

**PEAK SEARCH** PEAK EXCURSN 3 **dB**  
**DISPLAY** THRESHLD ON OFF (ON) 90 **-dBm**.

13. On the HP 8340A/B, set RF on. Adjust the power level until the HP 8902A reads -12 dBm ±0.05 dB.



#### 14. Spurious Response

14. Disconnect the power sensor from the directional bridge. Connect the directional bridge directly to the analyzer's RF INPUT using an adapter (do not use a cable). *Option 001 only:* Use a 75Ω adapter, BNC (m) to BNC (m).
15. On the analyzer, press **PEAK SEARCH**, **SIGNAL TRACK** (ON), **SPAN** 200 **kHz**. Wait for the AUTO ZOOM message to disappear. Press **SIGNAL TRACK** (OFF), **PEAK SEARCH**, **MKR ->**, **MARKER -> REF LVL**.
16. On the HP 3335A, set the 50Ω/75Ω switch to the 50Ω position (RF on). Adjust the amplitude until the two signals are displayed at the same amplitude.
17. If necessary, adjust the analyzer center frequency until the two signals are centered on the display. Set the controls as follows:  
RES BW ..... 10 kHz  
VIDEO BW ..... 300 Hz
18. Press **PEAK SEARCH**, **DISPLAY**, **DSP LINE ON OFF** (ON). Set the display line to a value 54 dB below the current reference level setting.
19. The third order intermodulation distortion products should appear 50 kHz below the lower frequency signal and 50 kHz above the higher frequency signal. Their amplitude should be less than the display line.
20. If the distortion products can be seen, proceed as follows:
  - a. On the analyzer, press **PEAK SEARCH**, **MARKER DELTA**.
  - b. Repeatedly press **NEXT PEAK** until the active marker is on the highest distortion product.
  - c. Record the MKR Δ amplitude reading below. The MKR Δ reading should be less than -54 dBc.

Third Order Intermodulation Distortion, 50 MHz \_\_\_\_\_ dBc.

21. If the distortion products cannot be seen, proceed as follows:
  - a. On both the HP 8340A/B and the HP 3335A, increase the POWER LEVEL by 5 dB. Distortion products should now be visible at this higher power level.
  - b. On the analyzer, press **PEAK SEARCH**, **MARKER DELTA**.
  - c. Repeatedly press **NEXT PEAK** until the active marker is on the highest distortion products.
  - d. On both the HP 8340A/B and the HP 3335A, reduce the power level by 5 dB and wait for the completion of a new sweep.
  - e. Record the MKR Δ amplitude reading below. The MKR Δ reading should be less than -54 dBc.

Third Order Intermodulation Distortion, 50 MHz \_\_\_\_\_ dBc.

## 15. Gain Compression

### Specification

INPUT 50 $\Omega$ :

>10 MHz  $\leq$ 0.5 dB for -10 dBm total power at input mixer.

### Description

Gain compression is measured by applying two signals, separated by 3 MHz. First, the test places a -30 dBm signal at the input of the spectrum analyzer (the analyzer's reference level is also set to -30 dBm). Then, a 0 dBm signal is applied to the analyzer, overdriving its input. The decrease in the first signal's amplitude (gain compression) caused by the second signal is the measured gain compression.

### Equipment

Synthesized Sweeper .....	HP 8340A/B
Synthesizer/Level Generator .....	HP 3335A
Measuring Receiver (used as a power meter).....	HP 8902A
Power Sensor .....	HP 8482A
Directional Bridge .....	HP 8721A

### Cables

BNC Cable, 120 cm (48 in) (2 required) .....	HP 10503A
--	-----------

### Adapters

Type N (f) to BNC (m) .....	1250-1477
Type N (m) to BNC (m) .....	1250-1473
Type N (f) to APC 3.5 (f) .....	1250-1745
Type N (m) to BNC (f) .....	1250-1476

### Additional Equipment for Option 001

Power Sensor, 75 $\Omega$ .....	HP 8483A
Adapter, type N (f) to BNC (m), 75 $\Omega$ .....	1250-1534

### Procedure

1. Zero and calibrate the HP 8902A and HP 8482A combination in log mode (power reads out in dBm). Enter the power sensor's 50 MHz Cal Factor into the HP 8902A.  
*Option 001:* Calibrate the HP 8483A 75 $\Omega$  power sensor.
2. Connect the equipment as shown in Figure 3-20, with the load (reflected) of the directional coupler connected to the power sensor. *Option 001:* Use the HP 8483A power sensor with a 1250-1534 Type N (f) to BNC (m) 75 $\Omega$  adapter and a 1250-1288 BNC (m) to BNC (m) adapter.

## 15. Gain Compression

### Note



For Option 001 only: The power measured at the output of the 50Ω directional bridge by the 75Ω power sensor, is the equivalent power “seen” by the 75Ω analyzer.

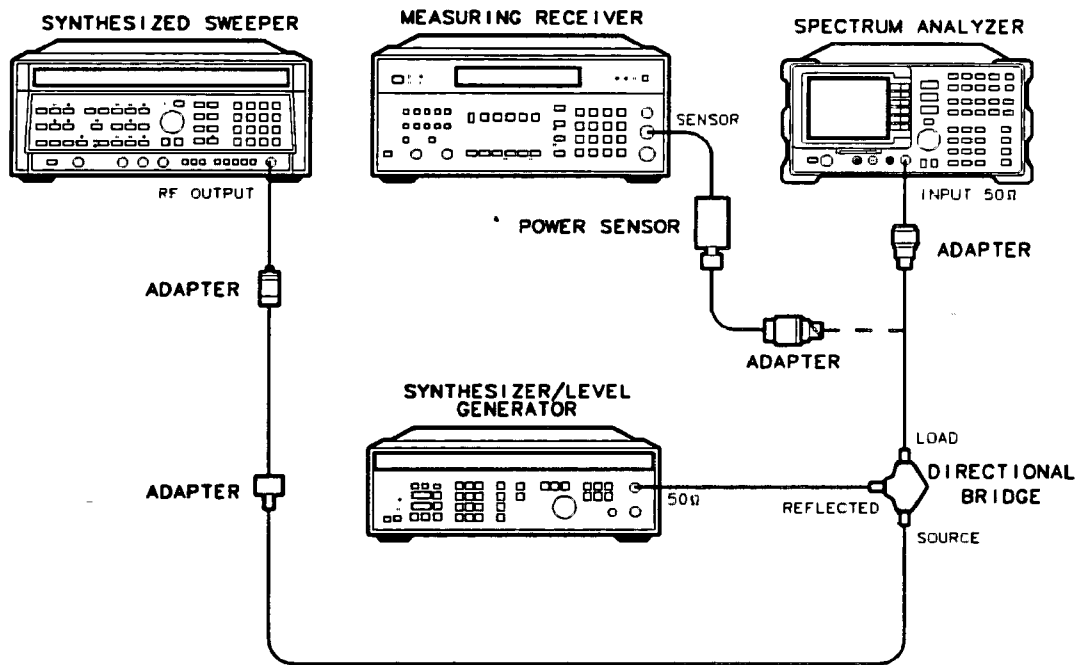

Figure 3-20. Gain Compression Test Setup

- Press **INSTR PRESET** on the HP 8340A/B. Set the HP 8340A/B controls as follows:

CW ..... 53 MHz  
 POWER LEVEL ..... 6 dBm

- Set the HP 3335A controls as follows:

CW ..... 50 MHz  
 AMPLITUDE ..... -14 dBm  
 50Ω/75Ω SWITCH ..... 75Ω (no RF output)

- On the analyzer, press **PRESET** and wait for the preset to finish. Set the controls as follows:

CENTER FREQUENCY ..... 50 MHz  
 SPAN ..... 20 MHz

Option 001: Press **AMPLITUDE**, MORE 1 of 2, AMPTD UNITS, dBm.

REF LEVEL ..... -20 dBm  
 LOG dB/DIV ..... 1 dB  
 RES BW ..... 300 kHz

- On the HP 8340A/B, adjust the power level for a 0 dBm reading on the HP 8902A. Set RF to off. On the HP 3335A, set the 50Ω/75Ω switch to 50Ω.

**Note**

The power level applied to the spectrum analyzer input is 10 dB greater than the specification to account for the 10 dB attenuation setting. A power level of 0 dBm at the analyzer input yields -10 dBm at the input mixer.

7. Disconnect the power sensor from the directional coupler and connect the directional coupler to the INPUT 50 $\Omega$  connector of the spectrum analyzer using an adapter. Do not use a cable. *Option 001:* Use a 75 $\Omega$  adapter, BNC (m) to BNC (m).
8. On the analyzer, press the following keys:

**PEAK SEARCH** **SIGNAL TRACK** (ON)  
**SPAN** 10 **MHz**.

Wait for the AUTO ZOOM message to disappear.

9. On HP 3335A, adjust the amplitude to place the signal 1 dB below the analyzer's reference level.
10. On the analyzer, press **PEAK SEARCH**, **MARKER DELTA**.
11. On the HP 8340A/B, set RF to on.
12. On the analyzer, press **PEAK SEARCH**, **NEXT PEAK**. The active marker should be on the lower amplitude signal and not on the signal that is off the top of the screen. If it is not on the lower amplitude signal, reposition the marker to this peak using the analyzer's knob.
13. Read the MKR  $\Delta$  amplitude and record below. The absolute value of this amplitude should be less than 0.5 dB.

Actual MKR  $\Delta$  Amplitude Reading \_\_\_\_\_ dB

---

## 16. Displayed Average Noise Level

### Specification

- 400 kHz to 1 MHz:  $\leq -115$  dBm.
- 1 MHz to 1.5 GHz:  $\leq -115$  dBm (*Option 001*:  $\leq -63$  dBmV).
- 1.5 GHz to 1.8 GHz:  $\leq -113$  dBm (*Option 001*:  $\leq -61$  dBmV).

### Related Adjustment

Frequency Response Adjustment.

### Description

This test measures the displayed average noise level within the frequency range specified. The analyzer's input is terminated in  $50\Omega$ .

The LO feedthrough is used as a frequency reference for these measurements. The test tunes the analyzer frequency across the band, uses the marker to locate the frequency with the highest response, and then reads the average noise in zero span.

To reduce measurement uncertainty due to input attenuator switching and resolution bandwidth switching, a reference level offset is added. The CAL OUT signal is used as the amplitude reference for determining the amount of offset required. The offset is removed at the end of the test by pressing **PRESET**.

### Equipment

50 $\Omega$  Termination ..... HP 908A

#### Cable

BNC, 23 cm (9 in) ..... HP 10502A

#### Adapters

Type N (m) to BNC (f) ..... 1250-1476

### Additional Equipment for Option 001

Cable, BNC 75 $\Omega$ , 30 cm (12 in) ..... 5062-6452

75 $\Omega$  Termination, Type N (m) ..... HP 909E, Option 201

Adapter, Type N (f) to BNC (m) 75 $\Omega$  ..... 1250-1534

### Procedure

1. Connect a cable from the CAL OUT to the INPUT 50 $\Omega$  of the analyzer as shown in Figure 3-21. *Option 001*: Use a 75 $\Omega$  cable and omit the adapter.

16. Displayed Average Noise Level

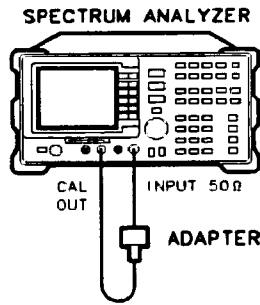

Figure 3-21. Displayed Average Noise Level Test Setup

Press **PRESET** and wait for the preset to finish. Set the controls as follows:

CENTER FREQUENCY ..... 300 MHz  
 SPAN ..... 10 MHz  
 REF LEVEL ..... -20 dBm  
 REF LEVEL (*Option 001*) ..... +28.75 dBmV  
 ATTEN ..... 0 dB

2. Press the following analyzer keys:

**PEAK SEARCH** **SIGNAL TRACK** (ON)  
**SPAN** 100 **kHz**.

Wait for the AUTO ZOOM message to disappear. Set the controls as follows:

VIDEO BW ..... 30 Hz  
 SIGNAL TRACK ..... OFF

3. Press **SGL SWP** and wait for completion of a new sweep. Press the following analyzer keys:

**PEAK SEARCH** **AMPLITUDE** MORE 1 of 2  
 REF LVL OFFSET .

Subtract the MKR amplitude reading from -20 dBm and

enter the result as the REF LVL OFFSET. For example, if the marker reads -20.21 dBm, enter +0.21 dB (-20 dBm - (-20.21 dBm) = +0.21 dB). *Example for Option 001:* If the marker reads 26.4 dBmV, enter +2.35 dBmV (28.75 dBmV - 26.4 dBmV = 2.35 dBmV).

REF LVL OFFSET \_\_\_\_\_ dB

*Option 001:* REF LVL OFFSET \_\_\_\_\_ dBmV

## 16. Displayed Average Noise Level

4. Disconnect the cable from the INPUT 50 $\Omega$  connector of the analyzer. Connect the 50 $\Omega$  termination to the analyzer INPUT 50 $\Omega$  connector. (*Option 001*: Use the 75 $\Omega$  termination.)

400 kHz

---

**Note** For *Option 001* only: Omit steps 5 through 9 and proceed to step 10.



5. Press the following analyzer keys:

VID BW AUTO MAN (AUTO).

Set the analyzer's controls as follows:

CENTER FREQUENCY ..... 0 Hz  
SPAN ..... 10 MHz  
REF LEVEL ..... -10 dBm  
TRIGGER ..... CONT

6. Press the following analyzer keys:

**PEAK SEARCH** **SIGNAL TRACK** (ON)  
**SPAN** 800 **kHz**.

Wait for the AUTO ZOOM message to disappear.

Press the following analyzer keys:

**SIGNAL TRACK** (OFF) **BW** 3 **kHz**  
**FREQUENCY**.

7. Adjust the center frequency until the LO feedthrough peak is on the left-most graticule line. Set the controls as follows:

SPAN ..... 50 kHz  
REF LEVEL ..... -50 dBm  
RES BW ..... 1 kHz  
VIDEO BW ..... 30 Hz  
SWEEP TIME ..... 5 s

Press **TRACE**, MORE 1 of 3, DETECTOR SAMPL PK (SAMPL), **SGL SWP**.

Wait for completion of a new sweep.

## 16. Displayed Average Noise Level

8. Press the following analyzer keys:

**DISPLAY**, **DSP LINE ON OFF (ON)**.

Adjust the display line so that it is centered on the average trace noise, ignoring any residual responses (refer to the Residual Responses verification test for any suspect residuals). Record the display line amplitude setting in Table 3-18 as the noise level at 400 kHz. The average noise level should be less than the specified limit.

**1 MHz**

9. Press the following analyzer keys:

**AUTO COUPLE** **RES BW AUTO MAN (AUTO)** **VID BW AUTO MAN (AUTO)**.

Set the analyzer's controls as follows:

CENTER FREQUENCY	.....	0 Hz
SPAN	.....	10 MHz
REF LEVEL	.....	-10 dBm
REF LEVEL ( <i>Option 001</i> )	.....	-35 dBmV
TRIGGER	.....	CONT

10. Press the following analyzer keys:

**PEAK SEARCH** **SIGNAL TRACK (ON)**  
**MKR ->** **MARKER ->REF LVL**  
**SPAN 2 MHz**.

Wait for the **AUTO ZOOM** message to disappear. Press **SIGNAL TRACK (OFF)**.

11. Press **FREQUENCY** and adjust the center frequency until the LO feedthrough peak is on the left-most graticule line. Set the controls as follows:

SPAN	.....	50 kHz
REF LEVEL	.....	-50 dBm
REF LEVEL ( <i>Option 001</i> )	.....	-1.2 dBmV
VIDEO BW	.....	30 Hz

12. Press **SGL SWP**. Wait for the completion of a new sweep.

13. Press the following analyzer keys:

**DISPLAY**, **DSP LINE ON OFF (ON)**.

Adjust the display line so that it is centered on the average trace noise, ignoring any residual responses (refer to the Residual Responses verification test for any suspect residuals). Record the display line amplitude setting in Table 3-18 as the noise level at 1 MHz. The average noise level should be less than the specified limit.



## 16. Displayed Average Noise Level

1 MHz to 1.5 GHz

14. Press the following analyzer keys:

**FREQUENCY** START FREQ 1 **MHz**  
STOP FREQ 1.5 **GHz**.

Set the controls as follows:

RES BW ..... 1 MHz  
VIDEO BW ..... 10 kHz  
TRIGGER ..... CONT

15. Adjust the START FREQ setting, if necessary, to place the LO feedthrough just off-screen to the left.
16. Press the following analyzer keys:

**SGL SWP**  
**TRACE** CLEAR WRITE A MORE 1 of 3  
VID AVG ON OFF (ON) 10 **Hz**.

Wait until AVG 10 is displayed to the left of the graticule (the analyzer will take ten sweeps, then stop).

17. Press **PEAK SEARCH** and record the MKR frequency as the Measurement Frequency in Table 3-18 for 1 MHz to 1.5 GHz.
18. Press the following analyzer keys:

**TRACE** MORE 1 of 3 VID AVG ON OFF (OFF)  
**AUTO COUPLE** RES BW AUTO MAN (AUTO)  
VID BW AUTO MAN (AUTO)  
**SPAN** 50 **kHz**  
**FREQUENCY** CENTER FREQ.

Set the center frequency to the Measurement Frequency recorded in Table 3-18 for 1 MHz to 1.5 GHz. Set the controls as follows:

RES BW ..... 1 kHz  
VIDEO BW ..... 30 Hz

19. Press **SGL SWP**.

Wait for the sweep to finish. Press the following analyzer keys:

**DISPLAY**, DSP LINE ON OFF (ON).

Adjust the display line so that it is centered on the average trace noise, ignoring any residual responses (refer to the Residual Responses verification test for any suspect residuals). Record the display line amplitude setting in Table 3-18. The average noise level should be less than the specified limit.

16. Displayed Average Noise Level

1.5 GHz to 1.8 GHz

20. Press the following analyzer keys:

**AUTO COUPLE** RES BW AUTO MAN (AUTO)  
 VID BW AUTO MAN (AUTO).

Set the controls as follows:

SPAN ..... 10 MHz  
 REF LEVEL ..... -50 dBm  
 REF LEVEL (Option 001) ..... -1.2 dBmV  
 TRIGGER ..... CONT

Press the following analyzer keys:

**FREQUENCY** START FREQ 1.5 **GHz**  
 STOP FREQ 1.8 **GHz**.

21. Repeat steps 16 through 19 above for frequencies from 1.5 GHz to 1.8 GHz.

**Note**



If the Displayed Average Noise at 1.8 GHz is at or out of specification, it is recommended that a known frequency source be used as a frequency marker. This ensures that testing is within 1.8 GHz.

**Table 3-18. Displayed Average Noise Level**

Frequency Range	Measurement Frequency	Displayed Average Noise Level (dBm) (Option 001: dBmV)	Specification (dBm) (Option 001: dBmV)
400 kHz	400 kHz	_____	-115 dBm
1 MHz	1 MHz	_____	-115 dBm (Option 001: <-63 dBmV)
1 MHz to 1.5 GHz	_____	_____	-115 dBm (Option 001: <-63 dBmV)
1.5 GHz to 1.8 GHz	_____	_____	-113 dBm (Option 001: <-61 dBmV)

---

## 17. Residual Responses

### Specification

With 0 dB INPUT ATTEN setting and input terminated:

< -90 dBm from 150 kHz to 1 MHz.

*Option 001:* Not applicable.

< -90 dBm from 1 MHz to 1.8 GHz.

*Option 001:* < -38 dBmV.

### Description

The spectrum analyzer's input is terminated and the analyzer is swept from 150 kHz to 1 MHz. Then the analyzer is swept in 10 MHz spans throughout the 1 MHz to 1.8 GHz range. Any responses above the specification are noted.

### Equipment

50 $\Omega$  Termination ..... HP 908A

### Additional Equipment for Option 001

75 $\Omega$  Termination, Type N (m) ..... 1250-1540

Adapter, Type N (f) to BNC (m), 75 $\Omega$  ..... 1250-1534

### Procedure

#### 150 kHz to 1 MHz

1. Connect the termination to the analyzer's input as shown in Figure 3-22. *Option 001:* Use the adapter to connect the 75 $\Omega$  termination, and proceed with step 5.

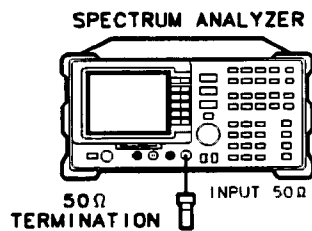

Figure 3-22. Residual Response Test Setup

## 17. Residual Responses

- Press **PRESET** on the analyzer and wait for the preset to finish. Press the following analyzer keys:

**PEAK SEARCH** **SIGNAL TRACK** (ON) **SPAN** 1 **MHz**.

Wait for the **AUTO ZOOM** message to disappear.

Press **SIGNAL TRACK** (OFF).

- Adjust the center frequency until the LO feedthrough peak is on the left-most vertical graticule line. Press the following analyzer keys: **PEAK SEARCH**, **MKR**. Set the controls as follows:

MARKER DELTA .....	150 kHz
MARKER .....	NORMAL
REF LVL .....	-60 dBm
ATTEN .....	0 dB
RES BW .....	3 kHz
VID BW .....	1 kHz
DISPLAY LINE .....	-90 dBm

- Press **SGL SWP** and wait for a new sweep to finish. Look for any residual responses at or above the display line. If a residual is suspected, press **SGL SWP** again. A residual response will persist on successive sweeps, but a noise peak will not. Note the frequency and amplitude of any residual responses above the display line and to the right of the marker in Table 3-19.

### 1 MHz to 1.8 GHz

- Press **PRESET** on the analyzer and wait for the preset to finish. Set the controls as follows:

CENTER FREQUENCY .....	5 MHz
SPAN .....	10 MHz
REF LEVEL .....	-60 dBm
REF LEVEL ( <i>Option 001</i> ) .....	-11.25 dBmV
ATTEN .....	0 dB

- Adjust the center frequency until the LO feedthrough (the "signal" near the left of the screen) is just off the left-most vertical graticule line. Set the controls as follows:

CF STEP .....	9.8 MHz
RES BW .....	10 kHz
VIDEO BW .....	3 kHz
DISPLAY LINE .....	-90 dBm
DISPLAY LINE ( <i>Option 001</i> ) .....	-38 dBmV

- Press **SGL SWP** and wait for a new sweep to finish. Look for any residual responses at or above the display line. If a residual is suspected, press **SGL SWP** again. A residual response will persist on successive sweeps, but a noise peak will not. Note the frequency and amplitude of any residual responses above the display line in Table 3-19.

## 17. Residual Responses

8. Press **FREQUENCY**, **▲** (step-up key), to step to the next frequency and repeat step 7.
9. Repeat steps 7 and 8 until the range from 1 MHz to 1.8 GHz has been checked. This requires 183 additional frequency steps. The test for this band requires about 10 minutes to complete if no residuals are found.

---

### Note



If there are any residuals at or near the frequency specification limits (1 MHz or 1.8 GHz), it is recommended that a known frequency source be used as a frequency marker. This will ensure that testing is done at or below the specification limits.

---

**Table 3-19. Residual Responses Above Display Line**

Frequency (MHz)	Amplitude (dBm)
_____	_____
_____	_____
_____	_____
_____	_____
_____	_____

---

## 18. 10 MHz Reference Output Accuracy (Option 004)

### Specification

Aging:

$\pm 1 \times 10^{-7}$  per year.

Warmup (Characteristic):

After 5 minutes from cold start \*,  $\pm 1 \times 10^{-7}$  of final stabilized frequency.†

After 30 minutes from cold start \*,  $\pm 1 \times 10^{-8}$  of final stabilized frequency.†

\* A cold start is defined as the analyzer being powered on after being off for at least 60 minutes.

†The final stabilized frequency is the frequency 60 minutes after being powered on.

### Related Adjustment

10 MHz Reference Adjustment (Option 004).

### Description

This test measures the warmup characteristics of the 10 MHz reference oscillator. The ability of the 10 MHz oscillator to meet its warmup characteristics gives a high level of confidence that it will also meet its yearly aging specification.

A frequency counter is connected to the 10 MHz REF OUTPUT. After the analyzer has been allowed to cool for at least 60 minutes, the analyzer is powered on. A frequency measurement is made five minutes after power is applied and the frequency is recorded. Another frequency measurement is made 25 minutes later (30 minutes after power is applied) and the frequency is recorded. A final frequency measurement is made 60 minutes after power is applied. The difference between each of the first two frequency measurements and the last frequency measurement is calculated and recorded.

### Equipment

Frequency Counter .....	HP 5334A/B
Frequency Standard—any 10 MHz frequency standard with aging rate of < $\pm 1 \times 10^{-10}$ per day such as the HP 5061B Cesium Beam Standard	
BNC Cable, 122 cm (48 in) (2 required) .....	HP 10503A

### Note



The spectrum analyzer must have been allowed to sit with the power off for at least 60 minutes before beginning this test. This adequately simulates a cold start.

---

## 18. 10 MHz Reference Output Accuracy (Option 004)

### Procedure

1. Allow the spectrum analyzer to sit with the power off for at least 60 minutes before proceeding. Connect the equipment as shown in Figure 3-23.

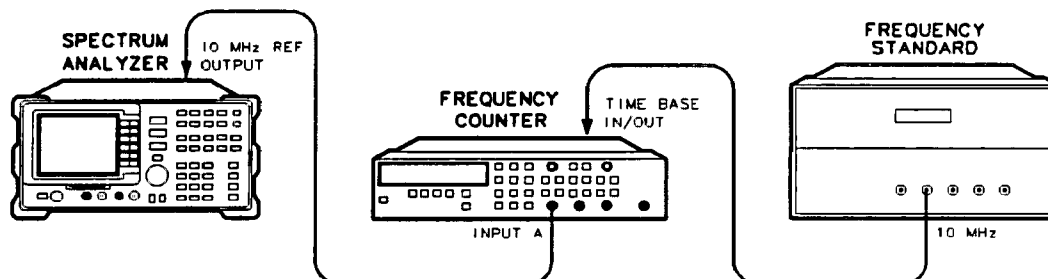

Figure 3-23. 10 MHz Reference Accuracy Test Setup, Option 004

2. Set the spectrum analyzer LINE switch on. Record the Power On Time below.

Power On Time \_\_\_\_\_

3. Set the counter controls as follows:

FUNCTION/DATA .....	FREQ A
INPUT A .....	
X10 ATTN .....	OFF
AC .....	OFF
50Ω Z .....	OFF
AUTO TRIG .....	ON
100 kHz FILTER A .....	OFF

4. On the frequency counter select a 10 second gate time by pressing **GATE TIME** 10 **GATE TIME**. Offset the displayed frequency by -10.0 MHz by pressing **MATH**, **SELECT/ENTER**, **CHS/EEX** 10 **CHS/EEX** 6 **SELECT/ENTER**, **SELECT ENTER**. The frequency counter should now display the difference between the INPUT A signal and 10.0 MHz with 0.001 Hz resolution.
5. Proceed with the next step 5 minutes after the Power On Time noted in step 2.
6. Wait at least two periods for the frequency counter to settle. Record the frequency counter reading below as Reading 1 with 0.001 Hz resolution.

Reading 1 \_\_\_\_\_ Hz

7. Proceed with the next step 15 minutes after the Power On Time noted in step 2.

**18. 10 MHz Reference Output Accuracy (Option 004)**

8. Record the frequency counter reading below as Reading 2 with 0.001 Hz resolution.

Reading 2 \_\_\_\_\_ Hz

9. Proceed with the next step 60 minutes after the Power On Time noted in step 2.  
10. Wait at least two periods for the frequency counter to settle. Record the frequency counter reading below as Reading 3 with 0.001 Hz resolution.

Reading 3 \_\_\_\_\_ Hz

11. Calculate the 5 Minute Warmup Error by subtracting Reading 3 from Reading 1 and dividing the result by 10 MHz.

$$5 \text{ Minute Warmup Error} = (\text{Reading 1} - \text{Reading 3}) / (10.0 \times 10^6)$$

5 Minute Warmup Error \_\_\_\_\_

12. Calculate the 30 Minute Warmup Error by subtracting Reading 3 from Reading 2 and dividing the result by 10 MHz.

$$30 \text{ Minute Warmup Error} = (\text{Reading 2} - \text{Reading 3}) / (10.0 \times 10^6)$$

30 Minute Warmup Error \_\_\_\_\_



---

## 19. Fast Time Domain Sweeps (Option 101)

### Specification

From 20 Milliseconds to 20 Microseconds, Zero SPAN mode:

Sweep Time Accuracy:  $\pm 2\%$ .

Amplitude Resolution: 0.7% of reference level for linear scale.

### Description

The CAL OUT signal is used to compare the amplitude level of a normal sweep time (20 ms) to a fast sweep time (18 ms) using the marker delta function.

A synthesizer/level generator is used to amplitude modulate a 500 MHz, CW signal from another signal generator. The analyzer demodulates this signal in zero span to display the response in the time domain. The marker delta frequency function on the analyzer is used to read out the sweep time.

### Equipment

Synthesizer/Function Generator ..... HP 3335A  
Signal Generator ..... HP 8640B

### Cables

BNC, 122 cm (48 in) ..... HP 10503A  
BNC, 23 cm (9 in) ..... HP 10502A  
Type N Cable, 152 cm (60 in) ..... HP 11500D

### Adapters

Type N (m) to BNC (f) ..... 1250-1476

### Additional Equipment for Option 001

Cable, BNC, 75 $\Omega$ , 30 cm (12 in) ..... 5062-6452  
Minimum Loss Adapter ..... HP 11852B  
Adapter, Type N (f) to BNC (m), 75 $\Omega$  ..... 1250-1534

### Procedure

#### Fast Sweep Time Amplitude Accuracy

1. Connect the equipment as shown in Figure 3-24. *Option 001:* Omit the adapter and use the 75 $\Omega$  cable.

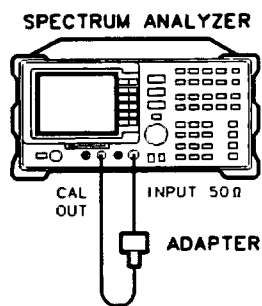

Figure 3-24. Fast Sweep Time Amplitude Test Setup

- On the analyzer, press **PRESET** and wait for the preset to finish. Set the controls as follows:

FREQUENCY ..... 300 MHz  
 SPAN ..... 0 Hz  
 SWEEP ..... 20 ms  
 AMPLITUDE SCALE ..... LINEAR  
 REF LEVEL ..... 25 mV  
 REF LEVEL (*Option 001*) ..... 30 mV

Press the following analyzer keys:

**MKR** MKNOISE ON OFF (ON).

- Press **SGL SWP**. Then press **MARKER DELTA**.
- Set the sweep time to 18 ms. Press **SGL SWP** and read the MKR  $\Delta$  amplitude. The amplitude should be within the following limits.

$$1.007X \leq \text{_____} \leq 0.993X$$

#### Fast Sweep Time Accuracy

- Connect the equipment as shown in Figure 3-25.
- Set the signal generator to output a 300 MHz, -4 dBm, CW signal. Set the AM and FM controls off.

*Option 001 only:* Set the output to +2 dBm.

- Set the synthesizer/level generator to output a 556 Hz, +5 dBm, signal.

## 19. Fast Time Domain Sweeps (Option 101)

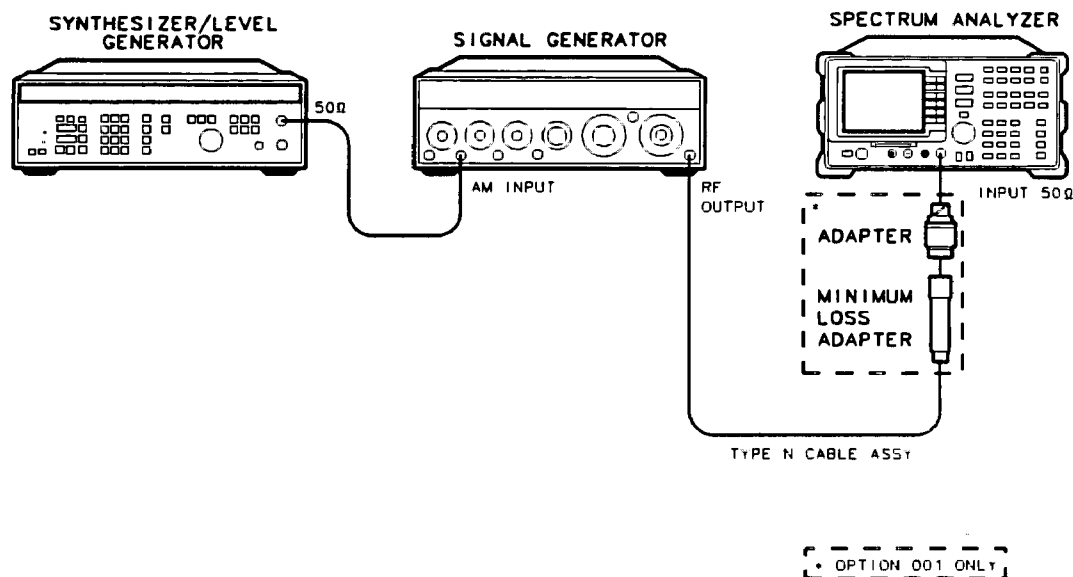

**Figure 3-25. Fast Sweep Time Test Setup, Option 101**

8. Press **PRESET** on the analyzer and wait for the preset to finish. Set the controls as follows:
 

FREQUENCY .....	300 MHz
SPAN .....	0 Hz
9. Set the signal generator AM switch to the AC position. If necessary, adjust the output amplitude of the signal generator to position the top of the modulated waveform approximately one division below top screen.
10. Set the analyzer controls as follows:
 

TRIG .....	VIDEO
SWEEP .....	18 ms
11. Press **SGL SWP**.
12. Press **PEAK SEARCH**. If necessary, press **NEXT PEAK** until the marker is on the left-most complete signal peak. This is the "marked signal."
13. Press **MARKER DELTA**, **MARKER DELTA** and press **NEXT PK RIGHT** until the marker  $\Delta$  is on eighth signal.
14. Record the MKR  $\Delta$  frequency reading in Table 3-20. The MKR reading should be within the limits shown.
15. Repeat steps 11 through 15 for the remaining sweep time settings listed in Table 3-20.

19. Fast Time Domain Sweeps (Option 101)

Table 3-20. Fast Sweep Time Accuracy

Analyzer Sweep Time	HP 3335A Frequency	Minimum Reading	MKR $\Delta$	Maximum Reading
18 ms	556 Hz	14.04 ms	_____	14.76 ms
10 ms	1 kHz	7.8 ms	_____	8.2 ms
5 ms	2 kHz	3.9 ms	_____	4.1 ms
2 ms	5 kHz	1.56 ms	_____	1.64 ms
1.0 ms	10 kHz	780 $\mu$ s	_____	820 $\mu$ s
500 $\mu$ s	20 kHz	390 $\mu$ s	_____	410 $\mu$ s
200 $\mu$ s	50 kHz	156 $\mu$ s	_____	164 $\mu$ s
100 $\mu$ s	100 kHz	78 $\mu$ s	_____	82 $\mu$ s
60 $\mu$ s	167 kHz	46.8 $\mu$ s	_____	49.2 $\mu$ s
40 $\mu$ s	250 kHz	31.2 $\mu$ s	_____	32.8 $\mu$ s
20 $\mu$ s	500 kHz	15.6 $\mu$ s	_____	16.4 $\mu$ s

---

## 20. Absolute Amplitude, Vernier, and Power Sweep Accuracy

### Specification

- Absolute Amplitude Accuracy:  $< \pm 1.0$  dB  
( $-20$  dBm setting at 300 MHz, SRC ATTEN coupled)  
(*Option 011*:  $+28.8$  dBmV setting at 300 MHz, SRC ATTEN coupled.)
- Vernier Accuracy:  $< \pm 0.75$  dB max  
(referred to  $-20$  dBm at any coupled SRC ATTEN setting at 300 MHz)  
(*Option 011*: referred to  $+28.8$  dBmV at any coupled SRC ATTEN setting at 300 MHz.)
- Power Sweep Accuracy:  $< 1.5$  dB peak-to-peak, over range from  
( $-15$  dBm to  $0$  dBm) – (SRC ATTEN setting)  
[*Option 011*: ( $+27.8$  to  $+42.8$  dBmV) – (SRC ATTEN setting)]

### Related Adjustment

Modulator Gain and Offset Adjustment.

### Description

The tracking generator output is connected to the spectrum analyzer input and the tracking is adjusted at 300 MHz for a maximum signal level. A calibrated power sensor is then connected to the tracking generator output to measure the power level at 300 MHz.

The measuring receiver is set for RATIO mode so that future power level readings are in dB relative to the power level at  $-20$  dBm (*Option 011*:  $+28.8$  dBmV). The output power level setting is decreased in 1 dB steps and the power level is measured at each step. The difference between the ideal and actual power levels is calculated at each step.

Since a power sweep is accomplished by stepping through the vernier settings, the peak-to-peak variation of the vernier accuracy is equal to the power sweep accuracy.

### Equipment

Measuring Receiver .....	HP 8902A
Power Sensor .....	HP 8482A
<b>Cable</b>	
Type N, 62 cm (24 in) .....	HP 11500B/C

**Additional Equipment for Option 011:**

Power Sensor .....	HP 8483A
BNC Cable, 75Ω .....	5062-6452
Adapter, Type N (f) to BNC (m), 75Ω .....	1250-1534
Mechanical Adapter, Type N, 50Ω (m) to 75Ω (f) .....	1250-0597

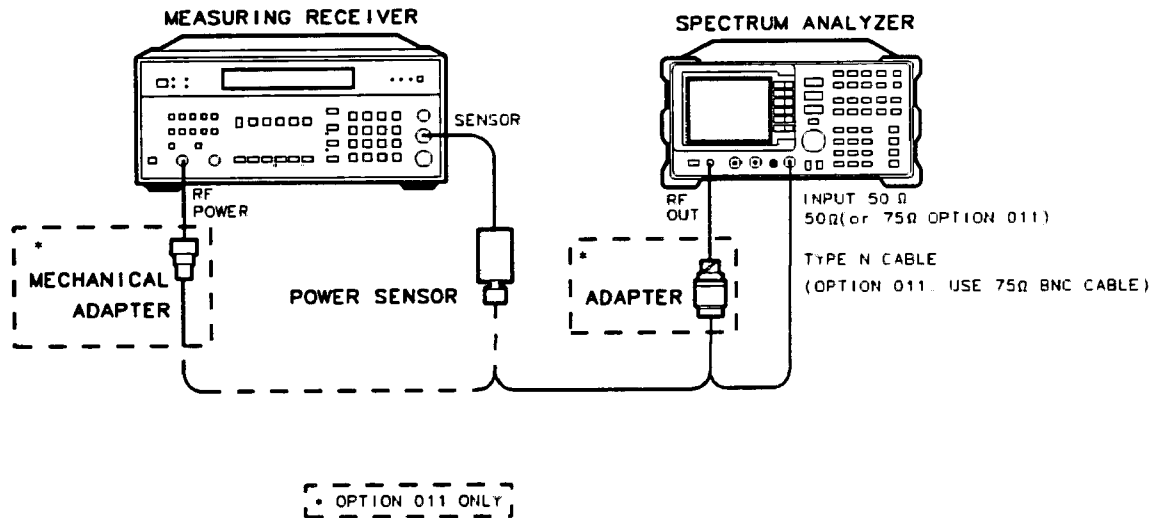

**Figure 3-26. Absolute Amplitude, Vernier, and Power Sweep Accuracy Test Setup**

**Procedure**

1. Connect the Type N cable between the RF OUT 50Ω and INPUT 50Ω connectors on the spectrum analyzer. See Figure 3-26.  
*Option 011:* Connect the BNC cable between the RF OUT 75Ω and INPUT 75Ω connectors on the spectrum analyzer.
2. Press **PRESET** on the spectrum analyzer and set the controls as follows:  
 CENTER FREQ ..... 300 MHz  
 SPAN ..... 0 Hz
3. On the spectrum analyzer, press **MKR**, **AUX CTRL**, **TRACK GEN**, **SRC PWR ON**, 5 **-dBm**.  
*Option 011:* 42 **+dBm** (+42 dBmV).
4. On the spectrum analyzer, press **TRACKING PEAK**. Wait for the **PEAKING** message to disappear.
5. Zero and calibrate the measuring receiver/power sensor combination in log mode (power levels readout in dBm). Enter the power sensor's 300 MHz Cal Factor into the measuring receiver.
6. Disconnect the Type N cable from the RF OUT 50Ω and connect the power sensor to the RF OUT 50Ω as shown in Figure 3-26.  
*Option 011:* Disconnect the BNC cable from the RF OUT 75Ω and connect the power sensor to the RF OUT 75Ω using an adapter.

**20. Absolute Amplitude, Vernier, and Power Sweep Accuracy**

7. On the spectrum analyzer, press 20 **-dBm**, **SGL SWP**.

*Option 011:* 28.8 **+dBm** (+28.8 dBmV), **SGL SWP**. Press SRC ATN MAN AUTO , SRC ATN MAN AUTO (“MAN” should be underlined).

8. Subtract -20 dBm from the power level displayed on the measuring receiver and record the result below as the Absolute Amplitude Accuracy.

Absolute Amplitude Accuracy \_\_\_\_\_dB

(Measurement Uncertainty: <+0.25/-0 26 dB)

9. Press RATIO on the measuring receiver. Power levels now readout in dB relative to the power level just measured at the -20 dBm output power level setting.

*Option 011:* +28.8 dBmV output power level setting.

10. Set the SRC POWER to the settings indicated in Table 3-21. At each setting, record the power level displayed on the measuring receiver.

11. Calculate the absolute vernier accuracy by subtracting the SRC POWER setting and 20 dB from the Measured Power Level for each SRC POWER setting in Table 3-21.

$$\text{Vernier Accuracy} = \text{Measured Power Level} - \text{SRC POWER} + 20 \text{ dB}$$

*OPTION 011:* Calculate the vernier accuracy by subtracting the SRC POWER setting from the Measured Power Level, adding 28.8 dB to each SRC POWER setting in Table 3-21.

$$\text{Vernier Accuracy} = \text{Measured Power Level} - \text{SRC POWER} - 28.8 \text{ dB}$$

12. Locate the most positive and most negative absolute vernier accuracy values for SRC POWER levels greater than -20 dBm in Table 3-21 and record below.

*Option 011:* For SRC POWER levels greater than +28.8 dBmV.

Positive Vernier Accuracy \_\_\_\_\_dB

Negative Vernier Accuracy \_\_\_\_\_dB

13. Locate the most positive and most negative Absolute Vernier Accuracy values for all SRC POWER levels in Table 3-21 and record below as the Positive Power Sweep Accuracy and Negative Power Sweep Accuracy.

Positive Power Sweep Accuracy \_\_\_\_\_dB

Negative Power Sweep Accuracy \_\_\_\_\_dB

**20. Absolute Amplitude, Vernier, and Power Sweep Accuracy**

14. Calculate the power sweep accuracy by subtracting the Negative Power Sweep Accuracy recorded in step 13 from the Positive Power Sweep Accuracy recorded in step 13.

$$\text{Power Sweep Accuracy} = \text{Positive Power Sweep Accuracy} - \text{Negative Power Sweep Accuracy}$$

Power Sweep Accuracy \_\_\_\_\_ dB pk-pk

**Table 3-21. Vernier Accuracy**

SRC POWER Setting		Measured Power Level	Vernier Accuracy	Measurement Uncertainty
Opt 011, dBmV	Opt 010, dBm	(dB)	(dB)	(dB)
+28.8	-20	0 (Ref)	0 (Ref)	0
+29.8	-19			±0.033
+30.8	-18			±0.033
+31.8	-17			±0.033
+27.8	-16			±0.033
+26.8	-15			±0.033
+25.8	-14			±0.033
+24.8	-13			±0.033
+23.8	-12			±0.033
+22.8	-11			±0.033
+21.8	-25			±0.033
+32.8	-24			±0.033
+31.8	-23			±0.033
+30.8	-22			±0.033
+29.8	-21			±0.033



---

## 21. Output Attenuator Accuracy

### Specification

$< \pm 0.8$  dB or 2.5% of SRC ATTEN setting, whichever is greater,  
 $\pm 1.5$  dB maximum, 0 to 60 dB settings, referred to 10 dB setting.

### Related Adjustment

Modulator Gain and Offset Adjustment.

### Description

The tracking generator output is connected to the spectrum analyzer's input and the tracking is adjusted at 30 MHz for a maximum signal level. The tracking generator output is then connected to the input of a measuring receiver. The measuring receiver is used in its tuned RF level (TRFL) mode to measure the attenuator accuracy relative to the 10 dB attenuator setting.

### Equipment

Measuring Receiver ..... HP 8902A

#### Cables

Type N, 62 cm (24 in) ..... HP 11500B/C

### Additional Equipment for Option 011:

Minimum Loss Adapter ..... HP 11852B

BNC Cable, 75 $\Omega$  ..... 5062-6452

Adapter, Type N (f) to BNC (m), 75 $\Omega$  ..... 1250-1534

## 21. Output Attenuator Accuracy

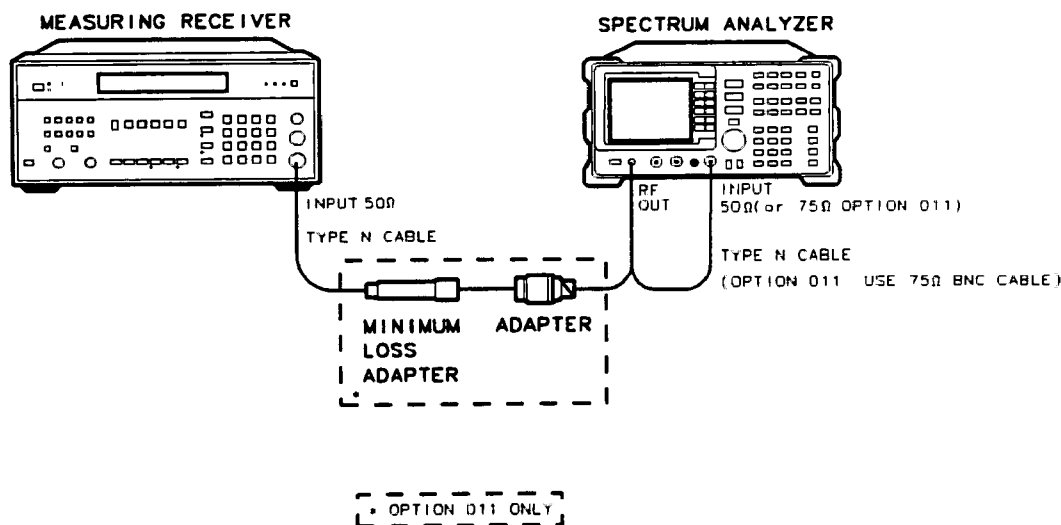

**Figure 3-27. Output Attenuator Accuracy Test Setup**

### Procedure

1. Connect the equipment as shown in Figure 3-27 with the Type N cable connected between the RF OUT 50Ω and the INPUT 50Ω connectors.  
*Option 011:* Connect the equipment with the BNC cable between the RF OUT 75Ω and the INPUT 75Ω connectors.
2. Press **PRESET** on the spectrum analyzer and set the controls as follows:
 

CENTER FREQ	.....	30 MHz
SPAN	.....	0 Hz
3. On the spectrum analyzer, press **MKR**, **AUX CTRL**, **TRACK GEN**, **SRC PWR ON**, 5 **-dBm**.  
*Option 011:* 42 **+dBm** (+42 dBmV).
4. On the spectrum analyzer, press **TRACKING PEAK**. Wait for the **PEAKING** message to disappear.
5. On the spectrum analyzer, press 20 **-dBm**.  
*Option 011:* 22.8 **+dBm** (+22.8 dBmV).
6. Connect the Type N cable between the tracking generator RF OUT 50Ω and the measuring receiver INPUT 50Ω connectors.  
*Option 011:* Use the minimum loss adapter and Type N (f) to BNC (m) adapter.
7. On the measuring receiver, press the blue **SHIFT** key, **AUTOMATIC OPERATION**, **FREQ**, MHz (INPUT FREQ), gold **SHIFT** key, **RF POWER (TUNED RF LEVEL)**, 4.4, **SPCL**, 32.0, **SPCL**, blue **SHIFT** key, **ZERO (SET REF)**, **LOG/LIN**. The display should read 0.00 dB ±0.01 dB.
8. Set the tracking generator SRC POWER to each of the settings other than -20 dBm (*Option 011:* other than +22.8 dBmV) listed in Table 3-22. If **RECAL** is displayed on the measuring receiver, press **CALIBRATE**. At each SRC POWER setting, calculate the Attenuator Accuracy as indicated below and record the result in Table 3-22.

## 21. Output Attenuator Accuracy

Attenuator Accuracy = Measuring Receiver Reading + SRC ATTEN Setting - 10 dB

**Table 3-22. Output Attenuator Accuracy**

SRC Power Setting		SRC ATTEN Setting	Attenuator Accuracy	Measurement Uncertainty
Opt 010, dBm	Opt 011, dBmV	(dB)	(dB)	(dB)
-10	+32.8	0		±0.6
-20	+22.8	10	0 (Ref)	0 (Ref)
-30	+12.8	20		±0.06
-40	+2.8	30		+0.07/-0.08
-50	-7.2	40		±0.09
-60	-17.2	50		±0.12
-70	-27.2	60		±0.13

## 22. Tracking Generator Level Flatness

### Specification

Flatness: (Referred to 300 MHz, 10 dB SRC ATTEN setting)

Option 010:  $<\pm 1.75$  dB, 100 kHz to 1.8 GHz

Option 011:  $<\pm 1.75$  dB, 1 MHz to 1.8 GHz

### Related Adjustment

Modulator Gain and Offset Adjustment.

### Description

The tracking generator output is connected to the spectrum analyzer input and the tracking is adjusted at 300 MHz for a maximum signal level. A calibrated power sensor is then connected to the tracking generator output to measure the power level at 300 MHz. The measuring receiver is set for RATIO mode so that future power level readings are in dB relative to the power level at 300 MHz.

The tracking generator is then stepped to several frequencies throughout its range. The output power difference relative to the power level at 300 MHz is measured at each frequency and recorded.

### Equipment

Measuring Receiver ..... HP 8902A

Power Sensor ..... HP 8482A

#### Cable

Type N, 62 cm (24 in) ..... HP 11500B/C

### Additional Equipment for Option 011:

Power Sensor ..... HP 8483A

BNC Cable, 75 $\Omega$  ..... 5062-6452

Adapter, Type N (f) to BNC (m), 75 $\Omega$  ..... 1250-1534

Mechanical Adapter, Type N, 50 $\Omega$  (m) to 75 $\Omega$  (f) ..... 1250-0597

## 22. Tracking Generator Level Flatness

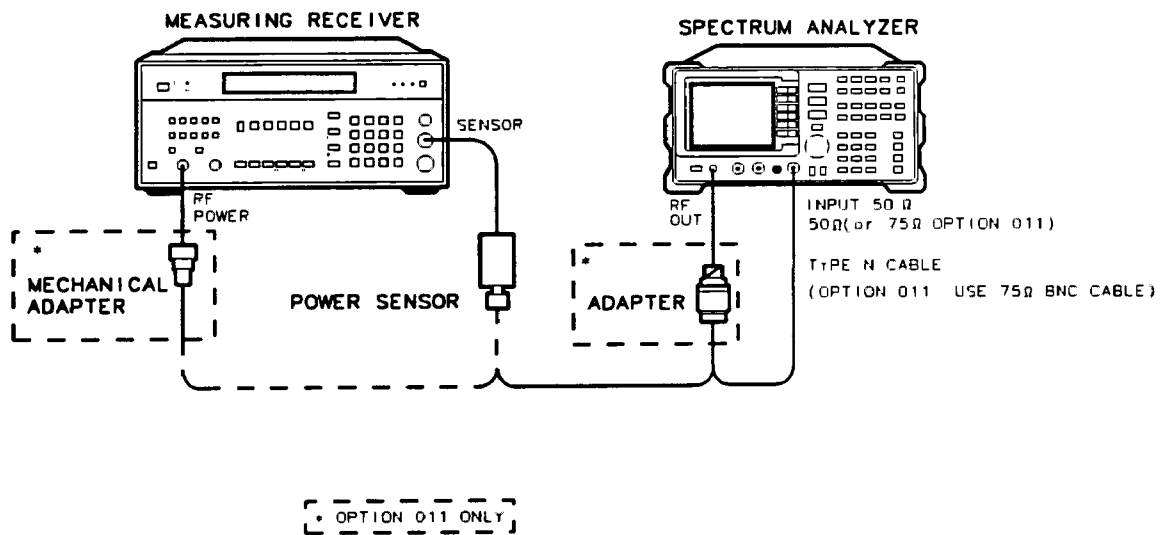

Figure 3-28. Tracking Generator Level Flatness Test Setup

### Procedure

1. Connect the Type N cable between the RF OUT 50 $\Omega$  and INPUT 50 $\Omega$  connectors on the spectrum analyzer. See Figure 3-28.  
*Option 011:* Connect the BNC cable between the RF OUT 75 $\Omega$  and INPUT 75 $\Omega$  connectors on the spectrum analyzer.
2. Press **PRESET** on the spectrum analyzer and set the controls as follows:
 

CENTER FREQ .....	300 MHz
CF STEP .....	100 MHz
SPAN .....	0 Hz
3. On the spectrum analyzer, press **MKR**, **AUX CTRL**, **TRACK GEN**, **SRC PWR ON**, 5 **-dBm**.  
*Option 011:* 42 **+dBm** (+42 dBmV).
4. On the spectrum analyzer, press **TRACKING PEAK**. Wait for the **PEAKING** message to disappear.
5. Zero and calibrate the measuring receiver/power sensor combination in log mode (power levels readout in dBm). Enter the power sensor's 300 MHz Cal Factor into the measuring receiver.
6. Disconnect the Type N cable from the RF OUT 50 $\Omega$  and connect the power sensor to the RF OUT 50 $\Omega$ .  
*Option 011:* Disconnect the BNC cable from the RF OUT 75 $\Omega$  and connect the power sensor to the RF OUT 75 $\Omega$  using an adapter.
7. On the spectrum analyzer, press 11 **-dBm**, **SGL SWP**.  
*Option 011:* 31.8 **+dBm** (+31.8 dBmV).
8. Press **RATIO** on the measuring receiver. The measuring receiver readout is now in power levels relative to the power level at 300 MHz.

## 22. Tracking Generator Level Flatness

9. Set the spectrum analyzer CENTER FREQ to 100 kHz. Press **SGL SWP**. *Option 011:* Set the spectrum analyzer CENTER FREQ to 1 MHz. Press **SGL SWP**.
10. Enter the appropriate power sensor Cal Factor into the measuring receiver as indicated in Table 3-23.
11. Record the power level displayed on the measuring receiver as the Level Flatness in Table 3-23.
12. Repeat steps 9 through 11 above to measure the flatness at each CENTER FREQ setting listed in Table 3-23. The **▲** (step-up key) may be used to tune to center frequencies above 100 MHz.

---

**Note** Analyzers equipped with Option 011 should be tested only at frequencies of 1 MHz to 1.8 GHz.



- 
13. Locate the most positive Level Flatness reading in Table 3-23 for the indicated frequency ranges and record as the Maximum Flatness.

Option 010:

Maximum Flatness, 100 kHz \_\_\_\_\_ dB

Maximum Flatness, 300 kHz to 5 MHz \_\_\_\_\_ dB

Maximum Flatness, 10 MHz to 1800 MHz \_\_\_\_\_ dB

Option 011:

Maximum Flatness, 1 MHz to 1800 MHz \_\_\_\_\_ dB

14. Locate the most negative Level Flatness reading in Table 3-23 for the indicated frequency ranges as the Minimum Flatness.

Option 010:

Minimum Flatness, 100 kHz \_\_\_\_\_ dB

Minimum Flatness, 300 kHz to 5 MHz \_\_\_\_\_ dB

Minimum Flatness, 10 MHz to 1800 MHz \_\_\_\_\_ dB

Option 011:

Minimum Flatness, 1 MHz to 1800 MHz \_\_\_\_\_ dB

15. Press **PRESET** on the spectrum analyzer.

## 22. Tracking Generator Level Flatness

**Table 3-23. Tracking Generator Level Flatness**

Center Freq	Level Flatness	Cal Factor	Measurement Uncertainty	
			Option 010	Option 011
	(dB)	(MHz)		
100 kHz*		0.1	+0.42/-0.45	N/A
300 kHz*		0.3	+0.28/-0.28	N/A
500 kHz*		0.3	+0.28/-0.28	N/A
1 MHz		1	+0.28/-0.28	+0.18/-0.39
2 MHz		3	+0.28/-0.28	+0.18/-0.39
5 MHz		3	+0.28/-0.28	+0.18/-0.39
10 MHz		10	+0.24/-0.24	+0.18/-0.39
20 MHz		30	+0.24/-0.24	+0.18/-0.39
50 MHz		50	+0.24/-0.24	+0.18/-0.39
100 MHz		100	+0.24/-0.24	+0.18/-0.39
200 MHz		300	+0.24/-0.24	+0.18/-0.39
300 MHz	0 (Ref)	300	0 (Ref)	0 (Ref)
400 MHz		300	+0.24/-0.24	+0.18/-0.39
500 MHz		300	+0.24/-0.24	+0.18/-0.39
600 MHz		300	+0.24/-0.24	+0.18/-0.39
700 MHz		1000	+0.24/-0.24	+0.18/-0.39
800 MHz		1000	+0.24/-0.24	+0.18/-0.39
900 MHz		1000	+0.24/-0.24	+0.18/-0.39
1000 MHz		1000	+0.24/-0.24	+0.18/-0.39
1100 MHz		1000	+0.24/-0.24	+0.18/-0.39
1200 MHz		1000	+0.24/-0.24	+0.18/-0.39
1300 MHz		1000	+0.24/-0.24	+0.18/-0.39
1400 MHz		1000	+0.24/-0.24	+0.18/-0.39
1500 MHz		2000	+0.24/-0.24	+0.18/-0.39
1600 MHz		2000	+0.24/-0.24	+0.18/-0.39
1700 MHz		2000	+0.24/-0.24	+0.18/-0.39
1800 MHz		2000	+0.24/-0.24	+0.18/-0.39

\* These frequencies are tested on Option 010 spectrum analyzers only.

## 23. Harmonic Spurious Outputs

### Specification

Harmonic Spurious:  $< -25$  dBc

### Related Adjustment

There are no related adjustment procedures for this performance test.

### Description

The tracking generator output is connected to the HP 8591A Spectrum Analyzer input and the tracking is adjusted at 300 MHz for a maximum signal level. The tracking generator output is then connected to the input of an HP 8566A/B Spectrum Analyzer. The tracking generator is tuned to several different frequencies and the amplitude of the second and third harmonics relative to the fundamental are measured at each frequency.

### Equipment

Microwave Spectrum Analyzer ..... HP 8566A/B

#### Cables

Type N, 62 cm (24 in) ..... HP 11500B/C

BNC, 23 cm (9 in) ..... HP 10502A

#### Adapter

Type N (m) to BNC (f) ..... 1250-1476

### Additional Equipment for Option 011:

Minimum Loss Adapter ..... HP 11852B

BNC Cable, 75 $\Omega$  ..... 5062-6452

Adapter, Type N (f) to BNC (m), 75 $\Omega$  ..... 1250-1534



## 23. Harmonic Spurious Outputs

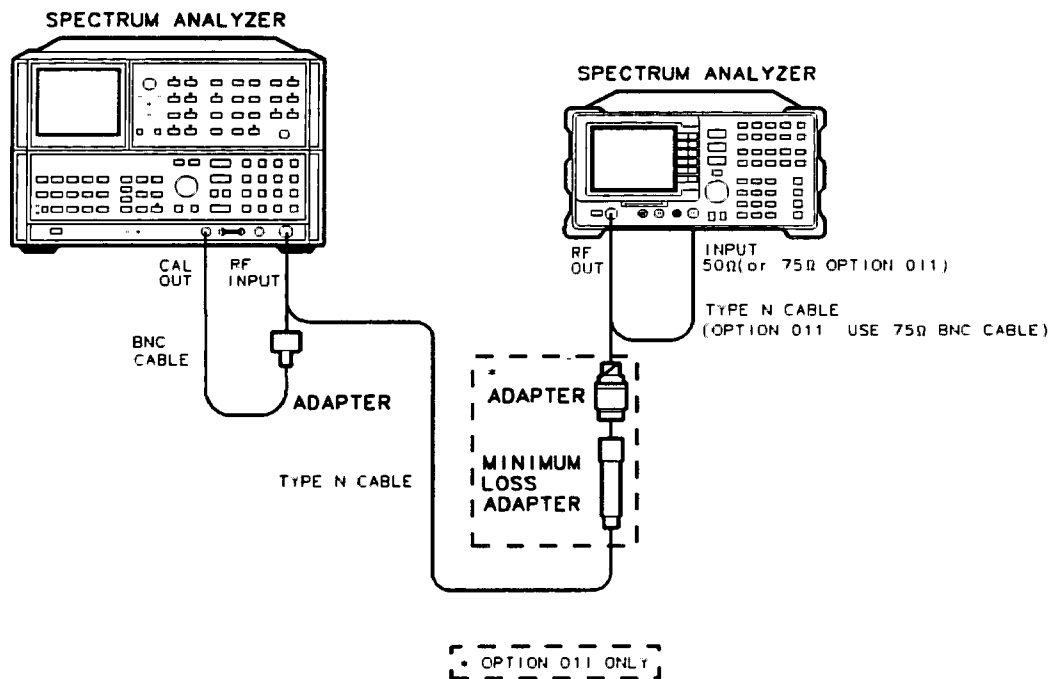

Figure 3-29. Harmonic Spurious Outputs Test Setup

### Procedure

1. Connect the Type N cable between the RF OUT 50 $\Omega$  and INPUT 50 $\Omega$  connectors on the HP 8591A Spectrum Analyzer. See Figure 3-29.  
*Option 011:* Connect the 75 $\Omega$  BNC cable between the RF OUT 75 $\Omega$  and INPUT 75 $\Omega$  connectors on the HP 8591A Spectrum Analyzer.
2. Press **PRESET** on the HP 8591A and set the controls as follows:
 

CENTER FREQ	.....	300 MHz
SPAN	.....	0 Hz
3. On the HP 8591A, press **MKR**, **AUX CTRL**, **TRACK GEN**, **SRC PWR ON**, 5 **-dBm**.  
*Option 011:* 42 **+dBm** (+42 dBmV).
4. On the HP 8591A, press **TRACKING PEAK**. Wait for the **PEAKING** message to disappear.
5. On the HP 8591A, press 0 **+dBm**, **FREQUENCY**, 10 **MHz**, **SGL SWP**.  
*Option 011:* 42.8 **+dBm** (42.8 dBmV).

### Note



It is only necessary to perform step 6 if more than two hours have elapsed since a front-panel calibration of the HP 8566A/B was performed.

The HP 8566A/B should be allowed to warm up for at least 30 minutes before proceeding.

6. Perform a front-panel calibration of the HP 8566A/B as follows:

## 23. Harmonic Spurious Outputs

- a. Connect a BNC cable between CAL OUTPUT and RF INPUT.
  - b. Press **2 - 22 GHz** (INSTR PRESET), **RECALL**, 8. Adjust AMPTD CAL for a marker amplitude reading of -10 dBm.
  - c. Press **RECALL**, 9. Adjust FREQ ZERO for a maximum amplitude response.
7. Connect the Type N cable from the tracking generator output to the HP 8566A/B RF INPUT as shown in Figure 3-29.  
*Option 011:* Use the minimum loss adapter and Type N (f) to BNC (m) adapter.
8. Set the HP 8566A/B controls as follows:

CENTER FREQUENCY .....	10 MHz
SPAN .....	100 kHz
REFERENCE LEVEL .....	+5 dBm
RES BW .....	30 kHz
LOG dB/DIV .....	10 dB

9. On the HP 8566A/B do the following:
- a. Press **PEAK SEARCH** and **SIGNAL TRACK** (ON). Wait for the signal to be displayed at center screen.
  - b. Press **PEAK SEARCH**, **MKR -> CF STEP**, **▲**, and **SIGNAL TRACK** (OFF).
  - c. Press **CENTER FREQUENCY**, **▲** (step-up key) to tune to the second harmonic. Press **PEAK SEARCH**. Record the marker amplitude reading in Table 3-24 as the 2nd Harmonic Level for the 10 MHz Tracking Generator Output Frequency.
  - d. Perform this step only if the Tracking Generator Output Frequency is less than 600 MHz. Press **CENTER FREQUENCY**, **▲** (step-up key) to tune to the third harmonic. Press **PEAK SEARCH**. Record the marker amplitude reading in Table 3-24 as the 3rd Harmonic Level for the 10 MHz Tracking Generator Output Frequency.
  - e. Press **MARKER OFF**.
10. Repeat steps 8 and 9 above for the remaining Tracking Generator Output Frequencies listed in Table 3-24. Note that the HP 8591A CENTER FREQ is the same as the Tracking Generator Output Frequency.

Locate the most positive 2nd Harmonic Level in Table 3-24 and record below.

2nd Harmonic Level \_\_\_\_\_dBc

11. Locate the most positive 3rd Harmonic Level in Table 3-24 and record below.

3rd Harmonic Level \_\_\_\_\_dBc

### 23. Harmonic Spurious Outputs

**Table 3-24. Harmonic Spurious Responses**

<b>Tracking Generator Frequency</b>	<b>2nd Harmonic Level (dBc)</b>	<b>3rd Harmonic Level (dBc)</b>	<b>Measurement Uncertainty (dB)</b>
10 MHz	_____	_____	+1.55/-1.80
100 MHz	_____	_____	+1.55/-1.80
300 MHz	_____	_____	+1.55/-1.80
850 MHz	_____	N/A	+1.55/-1.80

## 24. Non-Harmonic Spurious Outputs

### Specification

#### Non-Harmonic Spurious Outputs

Option 010:  $< -30$  dBc, 100 kHz to 1.8 GHz

Option 011:  $< -30$  dBc, 1 MHz to 1.8 GHz

### Related Adjustment

There are no related adjustments for this performance test.

### Description

The tracking generator output is connected to the HP 8591A Spectrum Analyzer input and the tracking is adjusted at 300 MHz for a maximum signal level. The tracking generator output is then connected to the input of an HP 8566A/B Spectrum Analyzer. The tracking generator is set to several different output frequencies.

For each output frequency, several sweeps are taken on the HP 8566A/B over different frequency spans and the highest displayed spurious response is measured in each span. Responses at the fundamental frequency of the tracking generator output or their harmonics are ignored. The amplitude of the highest spurious response is recorded.

### Equipment

Microwave Spectrum Analyzer ..... HP 8566A/B

#### Cables

Type N, 62 cm (24 in) ..... HP 11500B/C

BNC, 23 cm (9 in) ..... HP 10502A

#### Adapter

Type N (m) to BNC (f) ..... 1250-1476

### Additional Equipment for Option 011:

Minimum Loss Adapter ..... HP 11852B

BNC Cable, 75 $\Omega$  ..... 5062-6452

Adapter, Type N (f) to BNC (m), 75 $\Omega$  ..... 1250-1534

## 24. Non-Harmonic Spurious Outputs

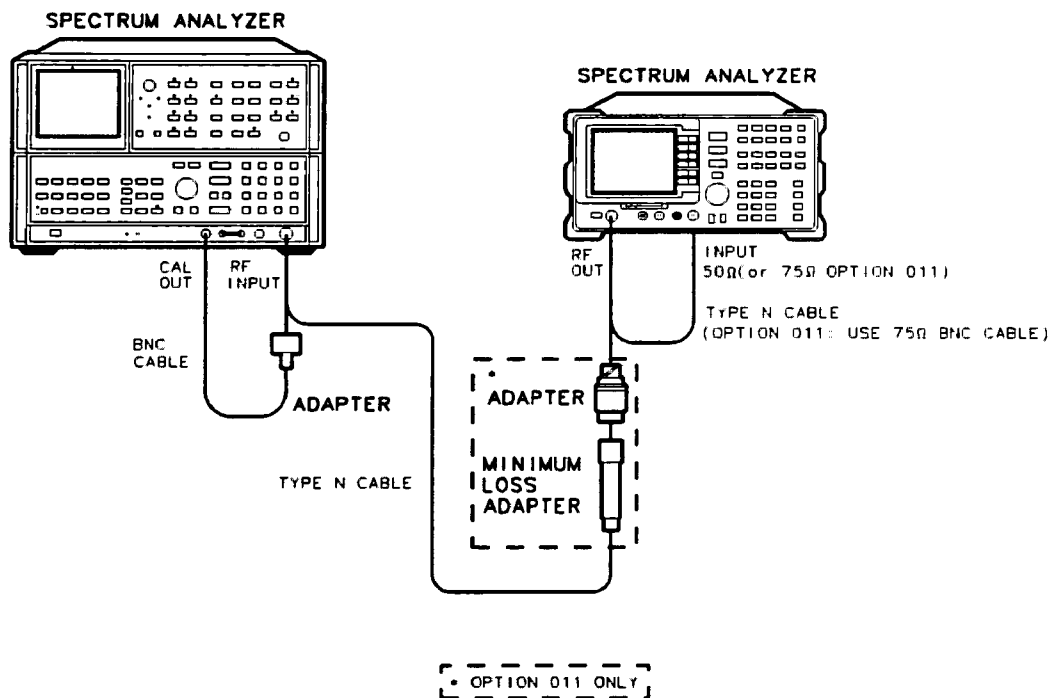

**Figure 3-30. Non-Harmonic Spurious Outputs Test Setup**

### Procedure

1. Connect the Type N cable between the RF OUT 50 $\Omega$  and INPUT 50 $\Omega$  connectors on the HP 8591A Spectrum Analyzer. See Figure 3-30.  
*Option 011:* Connect the 75 $\Omega$  BNC cable between the RF OUT 75 $\Omega$  and INPUT 75 $\Omega$  on the HP 8591A Spectrum Analyzer.
2. Press **PRESET** on the HP 8591A and set the controls as follows:
 

CENTER FREQ	.....	300 MHz
SPAN	.....	0 Hz
3. On the HP 8591A, press **MKR**, **AUX CTRL**, **TRACK GEN**, **SRC PWR ON**, **SRC PWR ON** ("ON" should be underlined), 5 **-dBm**. *Option 011:* 42 **+dBm** (+42 dBmV).
4. On the HP 8591A, press **TRACKING PEAK**. Wait for the **PEAKING** message to disappear.
5. On the HP 8591A, press 0 **+dBm**, **SGL SWP**.  
*Option 011:* 42.8 **+dBm** (+42.8 dBmV).

### Note



It is only necessary to perform step 6 if more than two hours has elapsed since a front-panel calibration of the HP 8566A/B has been performed.

The HP 8566A/B should be allowed to warm up for at least 30 minutes before proceeding.

6. Perform a front-panel calibration of the HP 8566A/B as follows:
  - a. Connect a BNC cable between CAL OUTPUT and RF INPUT.

## 24. Non-Harmonic Spurious Outputs

- b. Press **2 - 22 GHz** (INSTR PRESET), **RECALL**, 8. Adjust AMPTD CAL for a marker amplitude reading of -10 dBm.
  - c. Press **RECALL**, 9. Adjust FREQ ZERO for a maximum amplitude response.
  - d. Press **SHIFT**, **FREQUENCY SPAN** to start the 30 second internal error correction routine.
  - e. Press **SHIFT**, **START FREQ** to use the error correction factors just calculated.
7. Connect the Type N cable from the tracking generator output to the HP 8566A/B RF INPUT as shown in Figure 3-30.  
*Option 011:* Use the minimum loss adapter and Type N (f) to BNC (m) adapter.

### Measure Fundamental Amplitudes

8. Set the HP 8591A CENTER FREQ to the Fundamental Frequency listed in Table 3-25.
9. Set the HP 8566A/B controls as follows:

SPAN .....	100 kHz
REFERENCE LEVEL .....	+5 dBm
ATTEN .....	20 dB
10. Set the HP 8566A/B CENTER FREQUENCY to the Fundamental Frequency listed in Table 3-25.
11. On the HP 8566A/B, press **PEAK SEARCH**. Press **MKR -> REF LVL**. Wait for another sweep to finish.
12. Record the HP 8566A/B marker amplitude reading in Table 3-25 as the Fundamental Amplitude.
13. Repeat steps 8 through 12 for all Fundamental Frequency settings in Table 3-25.

### Measuring Non-Harmonic Responses

14. On the HP 8591A, set the CENTER FREQ to 10 MHz.
15. Set the HP 8566A/B START FREQ, STOP FREQ, and RES BW as indicated in the first row of Table 3-26.
16. Press SINGLE on the HP 8566A/B and wait for the sweep to finish. Press **PEAK SEARCH**.
17. Verify that the marked signal is not the fundamental or a harmonic of the fundamental as follows:
  - a. Divide the marker frequency by the fundamental frequency (the HP 8591A CENTER FREQ setting). For example, if the marker frequency is 30.3 MHz and the fundamental frequency is 10 MHz, dividing 30.3 MHz by 10 MHz yields 3.03.
  - b. Round the number calculated in step a the nearest whole number. In the example above, 3.03 should be rounded to 3.
  - c. Multiply the fundamental frequency by the number calculated in step b. Following the example, multiplying 10 MHz by 3 yields 30 MHz.
  - d. Calculate the difference between the marker frequency and the frequency calculated in step c above. Continuing the example, the difference would be 300 kHz.

## 24. Non-Harmonic Spurious Outputs

- e. Due to span accuracy uncertainties in the HP 8566A/B, the marker frequency might not equal the actual frequency. Given the marker frequency, check if the difference calculated in step d is within the appropriate tolerance:

For marker frequencies <5 MHz, tolerance =  $\pm 200$  kHz

For marker frequencies <55 MHz, tolerance =  $\pm 750$  kHz

For marker frequencies >55 MHz, tolerance =  $\pm 10$  MHz

- f. If the difference in step d is within the indicated tolerance, the signal in question is the fundamental signal (if the number in step b = 1) or a harmonic of the fundamental (if the number in step b >1). This response should be ignored.
18. Verify that the marked signal is a true response and not a random noise peak by pressing **SINGLE** to trigger a new sweep and press **PEAK SEARCH**. A true response will remain at the same frequency and amplitude on successive sweeps but a noise peak will not.
19. If the marked signal is either the fundamental or a harmonic of the fundamental (see step 17) or a noise peak (see step 18), move the marker to the next highest signal by pressing **SHIFT**, **PEAK SEARCH**. Continue with step 17.
20. If the marked signal is not the fundamental or a harmonic of the fundamental (see step 17) and is a true response (see step 18), calculate the difference between the amplitude of marked signal and the Fundamental Amplitude as listed in Table 3-25.

For example, if the Fundamental Amplitude for a fundamental frequency of 10 MHz is +1.2 dBm and the marker amplitude is -40.8 dBm, the difference is -42 dBc.

Record this difference as the Non-Harmonic Response Amplitude for the appropriate HP 8591A CENTER FREQ and HP 8566A/B START and STOP FREQ settings in Table 3-26.

$$\text{Non-Harmonic Amplitude} = \text{Marker Amplitude} - \text{Fundamental Amplitude}$$

21. If a true non-harmonic spurious response is not found, record "NOISE" as the Non-Harmonic Response Amplitude in Table 3-26 for the appropriate HP 8591A CENTER FREQ and HP 8566A/B START and STOP FREQ settings.
22. Repeat steps 16 through 21 for the remaining HP 8566A/B settings for START FREQ, STOP FREQ, and RES BW for the HP 8591A CENTER FREQ setting of 10 MHz.
23. Repeat steps 15 through 22 with the HP 8591A CENTER FREQ set to 900 MHz.
24. Repeat steps 15 through 22 with the HP 8591A CENTER FREQ set to 1.8 GHz.
25. Locate in Table 3-26 the most-positive Non-Harmonic Response Amplitude. Record this amplitude below.

Highest Non-Harmonic Response Amplitude \_\_\_\_\_ dBc

24. Non-Harmonic Spurious Outputs

Table 3-25. Fundamental Response Amplitudes

Fundamental Frequency	Fundamental Amplitude (dBm)
10 MHz	_____
900 MHz	_____
1.8 GHz	_____

Table 3-26. Non-Harmonic Responses

HP 8566A/B Settings			Non- Harmonic Response Amplitude (dBc)			Measurement Uncertainty
Start Freq (MHz)	Stop Freq (MHz)	Res BW	@10 MHz Center Freq	@900 MHz Center Freq	@1.8 GHz Center Freq	(dB)
0.1*	5.0	10 kHz	_____	_____	_____	+1.55/-1.80
5.0	55	100 kHz	_____	_____	_____	+1.55/-1.80
55	1240	1 MHz	_____	_____	_____	+1.55/-1.80
1240	1800	1 MHz	_____	_____	_____	+1.55/-1.80

\* Option 011: Set the START FREQ to 1 MHz.



---

## 25. Tracking Generator Feedthrough

### Specification

#### Tracking Generator Feedthrough

Option 010:  $<-106$  dBm, 1 MHz to 1.8 GHz

Option 011:  $<-57.24$  dBmV, 1 MHz to 1.8 GHz

### Related Adjustment

There are no related adjustments for this performance test.

### Description

The tracking generator output is connected to the spectrum analyzer's input and the tracking is adjusted at 300 MHz for a maximum signal level. The tracking generator output is terminated and set for 0 dBm output power (maximum output power). The spectrum analyzer's input is also terminated. The noise level of the spectrum analyzer is then measured at several frequencies.

### Equipment

50 $\Omega$  Termination (2 required) ..... HP 908A

#### Cables

Type N, 62 cm (24 in) ..... HP 11500B/C

BNC, 23 cm (9 in) ..... HP 10502A

#### Adapter

Type N (m) to BNC (f) ..... 1250-1476

### Additional Equipment for Option 011:

75 $\Omega$  Termination, Type N (m) (2 required) ..... HP 909E, Opt 201

BNC Cable, 75 $\Omega$  ..... 5062-6452

Adapter, Type N (f) to BNC (m), 75 $\Omega$  (2 required) ..... 1250-1534

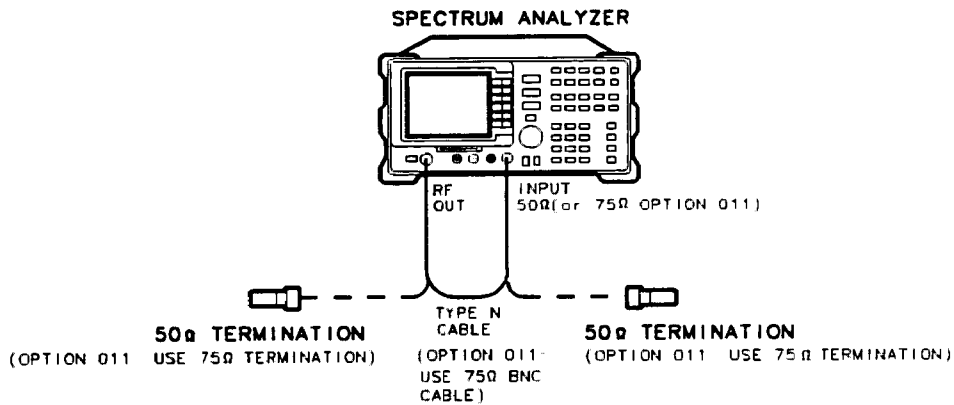

**Figure 3-31. Tracking Generator Feedthrough Test Setup**

### Procedure

1. Connect the Type N cable between the RF OUT 50Ω and INPUT 50Ω connectors on the spectrum analyzer. See Figure 3-31.  
*Option 011:* Connect the 75Ω BNC cable between the RF OUT 75Ω and INPUT 75Ω connectors on the spectrum analyzer.
2. Press **PRESET** on the spectrum analyzer and set the controls as follows:
 

CENTER FREQ	.....	300 MHz
SPAN	.....	1 MHz
3. On the spectrum analyzer, press **MKR**, **AUX CTRL**, **TRACK GEN**, **SRC PWR ON**, 5 **-dBm**.  
*Option 011:* 42 **+dBm** (+42 dBmV).
4. On the spectrum analyzer, press **TRACKING PEAK**. Wait for the **PEAKING** message to disappear.
5. Connect the CAL OUTPUT to the INPUT 50Ω.  
*Option 011:* Connect the CAL OUTPUT to the INPUT 75Ω.  
Set the spectrum analyzer controls as follows:
 

REF LEVEL	.....	-20 dBm
REF LEVEL ( <i>Option 011</i> )	.....	+28.75 dBmV
SPAN	.....	10 MHz
ATTEN	.....	0 dB
6. Press **PEAK SEARCH**, **SIGNAL TRACK** (ON), **SPAN**, 100 **kHz**. Wait for the **AUTO ZOOM** message to disappear. Set the controls as follows:
 

VIDEO BW	.....	30 Hz
SIGNAL TRACK	.....	OFF
7. Press **SGL SWP** and wait for completion of a new sweep. Press **PEAK SEARCH**, **AMPLITUDE**, **MORE 1 of 2**, **REF LVL OFFSET**. Subtract the MKR amplitude reading from -20 dBm and enter the result as the REF LVL OFFSET. For example, if the marker reads -20.21 dBm, enter +0.21 dB
 
$$[-20 \text{ dBm} - (-20.21 \text{ dBm}) = +0.21 \text{ dB}]$$

## 25. Tracking Generator Feedthrough

Example for *Option 001*: If the marker reads 26.4 dBmV, enter +2.35 **[dB]**

(28.75 dBmV - 26.4 dBmV = 2.35 dB).

REF LVL OFFSET \_\_\_\_\_dB

8. Connect one HP 908A 50Ω termination to the spectrum analyzer INPUT 50Ω and another to the tracking generator's RF OUT 50Ω.  
*Option 011*: Connect one HP 909E 75Ω termination to the spectrum analyzer INPUT 75Ω and another to the tracking generator's RF OUT 75Ω.
9. Press **[AUX CTRL]**, **TRACK GEN**, **SRC PWR OFF**.
10. Set the spectrum analyzer controls as follows:  
CENTER FREQ ..... 0 Hz  
SPAN ..... 10 MHz  
REF LVL ..... -10 dBm  
REF LVL (*Option 011*) ..... +38.75 dBmV  
VIDEO BW ..... AUTO  
Markers ..... OFF  
TRIG ..... CONT
11. Press **[PEAK SEARCH]**, **[SIGNAL TRACK]** (ON), **[MKR ->]**, **MARKER -> REF LVL**, **[SPAN]**, 2 **[MHz]**.  
Wait for the AUTO ZOOM message to disappear. Press **[SIGNAL TRACK]** (OFF).
12. Press **[FREQUENCY]** and adjust the center frequency until the LO feedthrough peak is on the left-most graticule line. Set the controls as follows:  
SPAN ..... 50 kHz  
REF LEVEL ..... -50 dBm  
REF LEVEL (*Option 011*) ..... -1.25 dBmV  
VIDEO BW ..... 30 Hz
13. Press **[AUX CTRL]**, **TRACK GEN**, **SRC PWR ON**, 0 **[+dBm]**.  
*Option 011*: 42.8 **[+dBm]** (+42.8 dBmV).
14. Press **[SGL SWP]** and wait for completion of a new sweep. Press **[DISPLAY]**,  
**DSP LINE ON OFF** (ON).
15. Adjust the display line so that it is centered on the average trace noise, ignoring any residual responses. Record the display line amplitude setting in Table 3-27 as the noise level at 1 MHz.
16. Repeat steps 14 and 15 for the remaining Tracking Generator Output Frequencies (spectrum analyzer CENTER FREQ) listed in Table 3-27.
17. In Table 3-27, locate the most positive Noise Level Amplitude. Record this amplitude here:

TG Feedthrough \_\_\_\_\_dBm

*Option 011*: TG Feedthrough \_\_\_\_\_dBmV

25. Tracking Generator Feedthrough

Table 3-27. TG Feedthrough

Tracking Generator Output Frequency	Noise Level Amplitude (dbm or dBmV)	Measurement Uncertainty (dB)
1 MHz		+1.15/-1.24
20 MHz		+1.15/-1.24
50 MHz		+1.15/-1.24
100 MHz		+1.15/-1.24
250 MHz		+1.15/-1.24
400 MHz		+1.15/-1.24
550 MHz		+1.15/-1.24
700 MHz		+1.15/-1.24
850 MHz		+1.15/-1.24
1000 MHz		+1.15/-1.24
1150 MHz		+1.15/-1.24
1300 MHz		+1.15/-1.24
1450 MHz		+1.15/-1.24
1600 MHz		+1.15/-1.24
1750 MHz		+1.15/-1.24

# Performance Verification Test Record

**Table 3-28. Performance Verification Test Record (Page 1 of 9)**

Hewlett-Packard Company			
Address: _____		Report No. _____	
_____		Date _____	
_____		(e.g. 10 SEP 1989)	
Model HP 8591A			
Serial No. _____			
Options _____			
Firmware Revision _____			
Customer _____		Tested by _____	
Ambient temperature _____ °C		Relative humidity _____ %	
Power mains line frequency _____ Hz (nominal)			
<b>Test Equipment Used:</b>			
<b>Description</b>	<b>Model No.</b>	<b>Trace No.</b>	<b>Cal Due Date</b>
Synthesized Sweeper	_____	_____	_____
Synthesizer/Function Generator	_____	_____	_____
Synthesizer/Level Generator	_____	_____	_____
AM/FM Signal Generator	_____	_____	_____
Measuring Receiver	_____	_____	_____
Power Meter	_____	_____	_____
RF Power Sensor	_____	_____	_____
High-Sensitivity Power Sensor	_____	_____	_____

Performance Verification Test Record (Page 2 of 9)

Hewlett-Packard Company		Report No. _____
Model HP 8591A		
Serial No. _____	Date _____	

Test Equipment Used:			
Description	Model No.	Trace No.	Cal Due Date
Microwave Frequency Counter	_____	_____	_____
Universal Frequency Counter	_____	_____	_____
Frequency Standard	_____	_____	_____
Power Splitter	_____	_____	_____
Minimum Loss Adapter	_____	_____	_____
(Options 001 and 011 only)			
50 MHz Low Pass Filter	_____	_____	_____
50Ω Termination	_____	_____	_____
75Ω Termination	_____	_____	_____
(Options 001 and 011 only)			
Microwave Spectrum Analyzer	_____	_____	_____
(Options 010 and 011 only)			
Notes/Comments			
_____			
_____			
_____			

**Performance Verification Test Record**

**Performance Verification Test Record (Page 3 of 9)**

Hewlett-Packard Company	Report No. _____
Model HP 8591A	
Serial No. _____	Date _____

Test No.	Test Description	Results Measured		Measurement Uncertainty
		Min	Max	
1.	<b>10 MHz Reference Accuracy (Standard Timebase)</b>  Aging Stability	Frequency Error		
		-1 × 10 <sup>-7</sup> -0.5 × 10 <sup>-6</sup>	+1 × 10 <sup>-7</sup> +0.5 × 10 <sup>-6</sup>	±4.7 × 10 <sup>-9</sup> ±4.2 × 10 <sup>-9</sup>
2.	<b>Frequency Readout Accuracy and Marker Count Accuracy</b> Frequency Readout Accuracy  SPAN 20 MHz 10 MHz 1 MHz  Marker Count Accuracy SPAN 20 MHz 1 MHz	Frequency (MHz)		
		1499.38	1500.62	± 1 Hz
		1499.68	1500.32	± 1 Hz
		1499.967	1500.034	± 1 Hz
		1499.99899	1500.00101	± 1 Hz
		1499.99989	1500.00011	± 1 Hz
3.	<b>Noise Sidebands</b> Noise Sideband Suppression		-65 dBc	± 1.0 dB
4.	<b>Residual FM</b>		400 Hz	± 45.8 Hz
5.	<b>System Related Sidebands</b>		-65 dBc	± 1.0 dB
6.	<b>Frequency Span Readout Accuracy</b>  SPAN Setting 500 MHz 1000 MHz 1800 MHz 100 MHz 50 MHz 20 MHz 10 MHz 5 MHz 2 MHz	MKRΔ Reading (MHz)		
		385.00	415.00	±1.77 MHz
		770.00	830.00	±3.54 MHz
		1446.00	1554.00	±6.37 MHz
		77.0	83.0	± 637 kHz
		38.5	41.5	± 177 kHz
		15.40	16.60	±70.8 kHz
		7.80	8.20	±35.4 kHz
		3.900	4.100	±17.7 kHz
		1.560	1.640	±7.08 kHz

Performance Verification Test Record (Page 4 of 9)

Hewlett-Packard Company	Report No. _____
Model HP 8591A	
Serial No. _____	Date _____

Test No.	Test Description	Results			Measurement Uncertainty
		Min	Measured	Max	
6.	<b>Frequency Span Readout Accuracy (continued)</b>	MKRA Reading (kHz)			
	SPAN Setting				
	1 MHz	780.0	_____	820.0	±3.54 kHz
	500 kHz	390.0	_____	410.0	±1.77 kHz
	200 kHz	156.0	_____	164.0	± 708 Hz
	100 kHz	78.0	_____	82.0	± 354 Hz
7.	<b>Sweep Time Accuracy</b>	MKRA Reading			
	SWEEP TIME Setting				
	20 ms	15.4 ms	_____	16.6 ms	±0.057 ms
	50 ms	38.5 ms	_____	41.5 ms	±0.141 ms
	100 ms	77.0 ms	_____	83.0 ms	±0.283 ms
	500 ms	385.0 ms	_____	415.0 ms	±1.41 ms
	1 s	770.0 ms	_____	830.0 ms	±2.83 ms
	10 s	7.7 s	_____	8.3 s	±23.8 ms
	50 s	38.5 s	_____	41.5 s	±141.4 ms
		100 s	77.0 s	_____	83.0 s
8.	<b>Scale Fidelity</b>				
	Incremental Error				
	dB from Ref Level				
	0	0 (Ref)	0 (Ref)	0 (Ref)	
	-2	-0.2 dB	_____	+0.2 dB	±0.06 dB
	-4	-0.2 dB	_____	+0.2 dB	±0.06 dB
	-6	-0.2 dB	_____	+0.2 dB	±0.06 dB
	-8	-0.2 dB	_____	+0.2 dB	±0.06 dB
	-10	-0.2 dB	_____	+0.2 dB	±0.06 dB
	Log Mode				
	dB from Ref Level				
	0	0 (Ref)	0 (Ref)	0 (Ref)	
	-10	-10.75 dB	_____	-9.25 dB	±0.06 dB
	-20	-20.75 dB	_____	-19.25 dB	±0.06 dB
	-30	-30.75 dB	_____	-29.25 dB	±0.06 dB
-40	-40.75 dB	_____	-39.25 dB	±0.06 dB	
-50	-50.75 dB	_____	-49.25 dB	±0.06 dB	
-60	-60.75 dB	_____	-59.25 dB	±0.11 dB	
-70	-71.00 dB	_____	-69.00 dB	±0.11 dB	



**Performance Verification Test Record**

**Performance Verification Test Record (Page 5 of 9)**

Hewlett-Packard Company	Report No. _____
Model HP 8591A	
Serial No. _____	Date _____

Test No.	Test Description	Results			Measurement Uncertainty
		Min	Measured	Max	
8.	<b>Scale Fidelity (continued)</b>				
	<b>Linear Mode</b>				
	% of Ref Level				
	100.00	0 (Ref)	0 (Ref)	0 (Ref)	
	70.70	150.98 mV	_____	165.20 mV	±1.84 mV
	50.00	104.69 mV	_____	118.91 mV	±1.84 mV
	35.48	72.22 mV	_____	86.44 mV	±1.84 mV
25.00	48.79 mV	_____	63.01 mV	±1.84 mV	
	<b>Log-to-Linear Switching</b>	-0.25 dB	_____	+0.25 dB	±0.05 dB
9.	<b>Input Attenuator Accuracy</b>				
	Attenuation (dB)				
	10	0 (Ref)	0 (Ref)	0 (Ref)	
	0	-0.5 dB	_____	+0.5 dB	+0.30/-0.31 dB
	20	-0.5 dB	_____	+0.5 dB	+/-0.12 dB
	30	-0.5 dB	_____	+0.5 dB	+/-0.12 dB
	40	-0.5 dB	_____	+0.5 dB	+/-0.12 dB
	50	-0.5 dB	_____	+0.5 dB	+/-0.12 dB
60	-0.75 dB	_____	+0.75 dB	+/-0.12 dB	
10.	<b>Reference Level Accuracy</b>				
	Log Mode				
	Reference Level (dBm)				
	-20	0 (Ref)	0 (Ref)	0 (Ref)	
	-10	-0.50 dB	_____	+0.50 dB	±0.06 dB
	0	-0.50 dB	_____	+0.50 dB	±0.06 dB
	-30	-0.50 dB	_____	+0.50 dB	±0.06 dB
	-40	-0.50 dB	_____	+0.50 dB	±0.08 dB
	-50	-0.50 dB	_____	+0.50 dB	±0.08 dB
	-60	-1.25 dB	_____	+1.25 dB	±0.12 dB
	-70	-1.25 dB	_____	+1.25 dB	±0.12 dB
-80	-1.25 dB	_____	+1.25 dB	±0.12 dB	
-90	-1.25 dB	_____	+1.25 dB	±0.12 dB	

Performance Verification Test Record (Page 6 of 9)

Hewlett-Packard Company	Report No. _____
Model HP 8591A	
Serial No. _____	Date _____

Test No.	Test Description	Results			Measurement Uncertainty
		Min	Measured	Max	
10.	<b>Reference Level Accuracy (continued)</b>				
	Linear Mode				
	Reference Level (dBm)				
	-20	0 (Ref)	0 (Ref)	0 (Ref)	
	-10	-0.50 dB	_____	+0.50 dB	±0.06 dB
	0	-0.50 dB	_____	+0.50 dB	±0.06 dB
	-30	-0.50 dB	_____	+0.50 dB	±0.06 dB
	-40	-0.50 dB	_____	+0.50 dB	±0.08 dB
	-50	-0.50 dB	_____	+0.50 dB	±0.08 dB
	-60	-1.25 dB	_____	+1.25 dB	±0.12 dB
-70	-1.25 dB	_____	+1.25 dB	±0.12 dB	
-80	-1.25 dB	_____	+1.25 dB	±0.12 dB	
-90	-1.25 dB	_____	+1.25 dB	±0.12 dB	
11.	<b>Resolution Bandwidth Switching Uncertainty</b>				
	RES BW Setting				
	3 kHz	0 (Ref)	0 (Ref)	0 (Ref)	
	1 kHz	-0.5 dB	_____	+0.5 dB	+0.07/-0.08 dB
	10 kHz	-0.4 dB	_____	+0.4 dB	+0.07/-0.08 dB
	30 kHz	-0.4 dB	_____	+0.4 dB	+0.07/-0.08 dB
	100 kHz	-0.4 dB	_____	+0.4 dB	+0.07/-0.08 dB
	300 kHz	-0.4 dB	_____	+0.4 dB	+0.07/-0.08 dB
1 MHz	-0.4 dB	_____	+0.4 dB	+0.07/-0.08 dB	
3 MHz	-0.4 dB	_____	+0.4 dB	+0.07/-0.08 dB	
12.	<b>Calibrator Amplitude Accuracy</b>				
	Non-Option 001	-20.4 dBm	_____	-19.6 dBm	± 0.2 dB
	Option 001	+28.35 dBmV	_____	+29.15 dBmV	± 0.2 dB
13.	<b>Frequency Response</b>				
	Max Positive Response		_____	+1.5 dB	+0.32/-0.33 dB
	Max Negative Response	-1.5 dB	_____		+0.32/-0.33 dB
	Peak-to-Peak Response		_____	2.0 dB	+0.32/-0.33 dB

**Performance Verification Test Record**

**Performance Verification Test Record (Page 7 of 9)**

Hewlett-Packard Company	Report No. _____
Model HP 8591A	
Serial No. _____	Date _____

Test No.	Test Description	Results			Measurement Uncertainty
		Min	Measured	Max	
14.	<b>Spurious Responses</b> Second Harmonic Distortion Third Order Inter-modulation Distortion		_____	-45 dBc	+1.86/-2.27 dB
			_____	-54 dBc	+2.07/-2.42 dB
15.	<b>Gain Compression</b>		_____	0.5 dB	+0.21/-0.22 dB
16.	<b>Displayed Average Noise Level</b> Non-Option 001: Frequency 400 kHz 1 MHz 1 MHz to 1.5 GHz 1.5 GHz to 1.8 GHz Option 001: Frequency 1 MHz 1 MHz to 1.5 GHz 1.5 GHz to 1.8 GHz		_____	-115 dBm	+1.15/-1.25 dB
			_____	-115 dBm	+1.15/-1.25 dB
			_____	-115 dBm	+1.15/-1.25 dB
			_____	-113 dBm	+1.15/-1.25 dB
			_____	-63 dBmV	+1.15/-1.25 dB
			_____	-63 dBmV	+1.15/-1.25 dB
			_____	-61 dBmV	+1.15/-1.25 dB
			_____		
17.	<b>Residual Responses</b> Non-Option 001: 150 kHz to 1 MHz 1 MHz to 1.8 GHz Option 001: 1 MHz to 1.8 GHz		_____	-90 dBm	+1.09/-1.15 dB
			_____	-90 dBm	+1.09/-1.15 dB
			_____	-38 dBmV	+1.09/-1.15 dB
18.	<b>10 MHz Reference Output Accuracy (Option 004)</b> 5 Minute Warmup Error 30 Minute Warmup Error	$-1 \times 10^{-7}$	_____	$+1 \times 10^{-7}$	$\pm 2.004 \times 10^{-9}$
		$-1 \times 10^{-8}$	_____	$+1 \times 10^{-8}$	$\pm 2.002 \times 10^{-9}$
			_____		

Performance Verification Test Record

Performance Verification Test Record (Page 8 of 9)

Hewlett-Packard Company	Report No. _____
Model HP 8591A	
Serial No. _____	Date _____

Test No.	Test Description	Results			Measurement Uncertainty
		Min	Measured	Max	
19.	<b>Fast Time Domain Sweeps (Option 101)</b>				
	Amplitude Resolution	0.933X	_____	1.007X	0%
	SWEEP TIME Setting				
	18 ms	14.04 ms	_____	14.76 ms	±0.5%
	10 ms	7.80 ms	_____	8.20 ms	±0.5%
	5 ms	3.90 ms	_____	4.10 ms	±0.5%
	2 ms	1.56 ms	_____	1.64 ms	±0.5%
	1.0 ms	780 μs	_____	820 μs	±0.5%
	500 μs	390 μs	_____	410 μs	±0.5%
	200 μs	156 μs	_____	164 μs	±0.5%
	100 μs	78 μs	_____	82 μs	±0.5%
	60 μs	46.8 μs	_____	49.2 μs	±0.5%
	40 μs	31.2 μs	_____	32.8 μs	±0.5%
20 μs	15.6 μs	_____	16.4 μs	±0.5%	
20.	<b>Absolute Amplitude, Vernier, and Power Sweep Accuracy</b>				
	Absolute Amplitude Accuracy	-1.0 dB	_____	+1.0 dB	+0.25/-0.26 dB
	Positive Vernier Accuracy			+0.75 dB	±0.033 dB
	Negative Vernier Accuracy	-0.75 dB	_____		±0.033 dB
	Power Sweep Accuracy			1.5 dB	±0.033 dB
21.	<b>Output Attenuator Accuracy</b>				
	SRC ATTEN Setting				
	0	-0.8 dB	_____	+0.8 dB	±0.60 dB
	10	0 (Ref)	0 (Ref)	0 (Ref)	0 (Ref)
	20	-0.8 dB	_____	+0.8 dB	±0.06 dB
	30	-0.80 dB	_____	+0.80 dB	+0.07/-0.08 dB
	40	-1.0 dB	_____	+1.0 dB	±0.09 dB
	50	-1.25 dB	_____	+1.25 dB	±0.12 dB
60	-1.50 dB	_____	+1.50 dB	±0.13 dB	

**Performance Verification Test Record**

**Performance Verification Test Record (Page 9 of 9)**

Hewlett-Packard Company	Report No. _____
Model HP 8591A	
Serial No. _____	Date _____

Test No.	Test Description	Results			Measurement Uncertainty
		Min	Measured	Max	
22.	<b>Tracking Generator Level Flatness</b>				
	Option 010:				
	Maximum Flatness				
	100 kHz		_____	+1.75 dB	+0.42/-0.45 dB
	300 kHz to 5 MHz		_____	+1.75 dB	+0.28/-0.28 dB
	10 MHz to 1800 MHz		_____	+1.75 dB	+0.24/-0.24 dB
	Minimum Flatness				
	100 kHz	-1.75 dB	_____		+0.42/-0.45 dB
	300 kHz to 5 MHz	-1.75 dB	_____		+0.28/-0.28 dB
10 MHz to 1800 MHz	-1.75 dB	_____		+0.24/-0.24 dB	
23.	<b>Harmonic Spurious Outputs</b>				
	2nd Harmonic Level		_____	-25 dBc	+1.55/-1.80 dB
	3rd Harmonic Level		_____	-25 dBc	+1.55/-1.80 dB
24.	<b>Non-Harmonic Spurious Outputs</b>				
	Highest Non-Harmonic Response Amplitude		_____	-30 dBc	+1.55/-1.80 dB
25.	<b>Tracking Generator Feedthrough</b>				
	TG Feedthrough (Opt 010)		_____	-106 dBm	+1.15/-1.24 dB
	TG Feedthrough (Opt 011)		_____	-57.24 dBmV	+1.15/-1.24 dB



## Verifying Specified Operation for the HP 8593A

---

### What You'll Find in This Chapter

This chapter contains test procedures which test the electrical performance of the HP 8593A Spectrum Analyzer.

None of the test procedures involve removing the cover of the spectrum analyzer.

### What is Performance Verification?

Performance Verification verifies that the spectrum analyzer performance is within all specifications of Table 1-3. It is time-consuming and requires extensive test equipment. Performance Verification consists of *all* the performance tests. See Table 4-1 for a complete listing of performance tests.

**Table 4-1. Performance Verification Tests for the HP 8593A**

Test Number	Test Name
1.	10 MHz Reference Accuracy (Standard Timebase)
2.	Comb Generator Frequency Accuracy
3.	Frequency Readout Accuracy and Marker Count Accuracy
4.	Noise Sidebands
5.	System Related Sidebands
6.	Residual FM
7.	Frequency Span Readout Accuracy
8.	Sweep Time Accuracy
9.	Scale Fidelity
10.	Input Attenuator Accuracy
11.	Reference Level Accuracy
12.	Resolution Bandwidth Switching Uncertainty
13.	Calibrator Amplitude Accuracy
14.	Frequency Response
15.	Other Input Related Spurious
16.	Spurious Response
17.	Gain Compression
18.	Displayed Average Noise Level
19.	Residual Responses
20.	10 MHz Reference Output Accuracy (Option 004)
21.	Fast Time Domain Sweeps (Option 101)

## What Is Operation Verification?

Operation Verification consists of a subset of the performance tests which test only the most critical specifications of the analyzer. It requires less time and equipment than the Performance Verification and is recommended for verification of over all instrument operation, either as part of incoming inspection or after repair. Operation Verification consists of the following performance tests:

**Table 4-2. Operation Verification Tests for the HP 8593A**

Test Number	Test Name
3.	Frequency Readout Accuracy and Marker Count Accuracy
4.	Noise Sidebands
7.	Frequency Span Readout Accuracy
9.	Scale Fidelity
10.	Input Attenuator Accuracy
11.	Reference Level Accuracy
12.	Resolution Bandwidth Switching Uncertainty
13.	Calibrator Amplitude Accuracy
14.	Frequency Response
16.	Second Harmonic Distortion (part of Spurious Response)
18.	Displayed Average Noise Level

### Before You Start the Verification Tests

There are four things you should do before starting a verification test:

1. Switch the analyzer on and let it warm up in accordance with the Temperature Stability specification in Table 1-3.
2. Read "Making a Measurement" in Chapter 5.
3. After the analyzer has warmed up as specified, perform the self-calibration procedure documented in "Improving Accuracy With Calibration Routines" in Chapter 5. The performance of the analyzer is only specified after the analyzer calibration routines have been run and if the analyzer is autocoupled.
4. Read the rest of this section before you start any of the tests, and make a copy of the Performance Verification Test Record described in "Recording the Test Results."

### Test Equipment You'll Need

Table 4-3 lists the recommended test equipment for the performance tests. The table also lists recommended equipment for the analyzer's adjustment procedures which are located in the *HP 8593A Service Manual*. Any equipment that meets the critical specifications given in the table can be substituted for the recommended model(s).



## **Recording the Test Results**

A small test results table is provided at the end of each test procedure for your convenience in recording test results as you perform the procedure.

In addition, a complete Performance Verification Test Record, Table 4-30, has been provided at the end of the chapter. We recommend that you make a copy of the table, record the test results on the copy, and keep the copy for your calibration test record. This record could prove valuable in tracking gradual changes in test results over long periods of time.

## **If the Analyzer Doesn't Meet Specifications**

If the analyzer fails a test, rerun the **CAL FREQ & AMPTD** routine, press **CAL STORE**, and repeat the test. If the analyzer still fails one or more specifications, complete any remaining tests and record all test results on a copy of the test record. Then refer to "Problems" in Chapter 8, for instructions on how to solve the problem.

## **Periodically Verifying Operation**

The analyzer requires periodic verification of operation. Under most conditions of use, you should test the analyzer at least once a year with either Operation Verification or the complete set of Performance Verification tests.

**Table 4-3. Recommended Test Equipment**

Instrument	Critical Specifications for Equipment Substitution	Recommended Model	Use*
Synthesized † Sweeper	Frequency Range: 10 MHz to 22 GHz Frequency Accuracy (CW): ±0.02% Leveling Modes: Internal and External Modulation Modes: AM Power Level Range: -35 to +16 dBm (2 required)	HP 8340A/B	P,A,T
Synthesizer Function Generator	Frequency Range: 0.1 Hz to 500 Hz Frequency Accuracy: ±0.02% Waveform: Triangle	HP 3325B	P,T
Synthesizer/ Level Generator	Frequency Range: 500 Hz to 80 MHz Amplitude Range: +12 to -85 dBm Flatness: ±0.15 dB Attenuator Accuracy: ±0.09 dB	HP 3335A	P,A,T
AM/FM Signal Generator	Frequency Range: 1 MHz to 1000 MHz Amplitude Range: -35 to +16 dBm SSB Noise: <-120 dBc/Hz at 20 kHz offset	HP 8640B Option 002	P,A,T
Measuring Receiver	Compatible with Power Sensors dB Relative Mode Resolution: 0.01 dB Reference Accuracy: ±1.2%	HP 8902A	P,A,T
Power Meter	Power Range: Calibrated in dBm and dB relative to reference power -70 dBm to +44 dBm, sensor dependent	HP 436A	P,A,T
Power Sensor	Frequency Range: 1 MHz to 350 MHz Maximum SWR: 1.1 (1 MHz to 2.0 GHz) 1.30 (2.0 to 2.9 GHz)	HP 8482A	P,A,T
Low Power Sensor	Frequency Range: 300 MHz Amplitude Range: -20 dBm to -70 dBm Maximum SWR: 1.1 (300 MHz)	HP 8484A	P,T,A
Power Sensor	Frequency Range: 50 MHz to 26.5 GHz Maximum SWR: 1.15 (50 MHz to 100 MHz) 1.10 (100 MHz to 2 GHz) 1.15 (2.0 GHz to 12.4 GHz) 1.20 (12.4 GHz to 18.0 GHz) 1.25 (18 GHz to 26.5 GHz)	HP 8485A	P,A,T
Microwave Frequency Counter	Frequency Range: 9 MHz to 7 GHz Timebase Accy (Aging) <5 × 10 <sup>-10</sup> /day	HP 5343A	P,A,T

\* P = Performance Test, A = Adjustment, T = Troubleshooting

† Option 026 requires one synthesizer to go to 26.5 GHz

**4-4 Verifying Specified Operation for the HP 8593A**

**Table 4-3. Recommended Test Equipment (continued)**

Instrument	Critical Specifications for Equipment Substitution	Recommended Model	Use*
Spectrum Analyzer	Frequency Range: 10 MHz to 7 GHz	HP 8566A/B	A,T
Universal † Frequency Counter	Frequency: 10 MHz Resolution: ± 0.002 Hz External Timebase	HP 5334A/B	P,A,T
Frequency Standard	Frequency: 10 MHz Timebase Accy. (Aging): <math>1 \times 10^{-9}</math>/day	HP 5061B	P,A
Oscilloscope	Bandwidth: dc to 100 MHz Vertical Scale Factor of 0.5 V to 5 V/Div External Trigger Mode	HP 1741A	T
Digital Voltmeter	Input Resistance: ≥10 megohms Accuracy: ±10 mV on 100 V range	HP 3456A	P,A,T
DVM Test Leads	For use with HP 3456A	HP 34118	A,T
Power † Splitter	Frequency Range: 50 kHz to 22 GHz Insertion Loss: 6 dB (nominal) Output Tracking: <math>0.25</math> dB Equivalent Output SWR: <math>1.22:1</math>	HP 11667B	P,A
Directional Bridge	Frequency Range: 0.1 to 110 MHz Directivity: >40 dB Maximum VSWR: 1.1:1 Transmission Arm Loss: 6 dB (nominal) Coupling Arm Loss: 6 dB (nominal)	HP 8721A	P,T
Directional Coupler	Frequency Range: 1.7 GHz to 8 GHz Coupling: 16 dB (nominal) Max. Coupling Deviation: ± 1 dB Directivity: 14 dB minimum Flatness: 0.75 dB maximum VSWR: <math>1.45</math> Insertion Loss: <math>1.3</math> dB	0955-0125	P,T
Low Pass Filter	Cutoff Frequency: 300 MHz Bandpass Insertion Loss: <math>0.9</math> dB at 300 MHz Stopband Insertion Loss: >40 dB at 435 MHz	0955-0455	P,A,T
* P = Performance Test, A = Adjustment, T=Troubleshooting			
† Option 004			
‡ Option 026 Frequency Range: 50 kHz to 26.5 GHz			

**Table 4-3. Recommended Test Equipment (continued)**

Instrument	Critical Specifications for Equipment Substitution	Recommended Model	Use*
10 dB Attenuator	Type N (m to f) Frequency: 300 MHz	HP 8491A Option 010	
20 dB Attenuator	Type N (m to f) Attenuation: 20 dB Frequency: dc to 12.4 GHz	HP 8491A Option 020	A
1 dB Step Attenuator	Attenuation Range: 0 to 12 dB Frequency Range: 50 MHz Connectors: BNC female	HP 355C	P,A
10 dB Step Attenuator	Attenuation Range 0 to 30 dB Frequency Range: 50 MHz Connectors: BNC female	HP 355D	P,A
Low Pass Filter	Cutoff Frequency: 4.4 GHz Rejection at 5.5 GHz: >40 dB	HP 11689A	P,T
Low Pass Filter	Cutoff Frequency: 50 MHz Rejection at 80 MHz: >50 dB	0955-0306	P,T
Termination	Impedance: 50 ohms (nominal)	HP 909D	P,T
Logic Pulser	TTL voltage and current drive levels	HP 546A	T
Digital Current Tracer	Sensitivity: 1 mA to 500 mA Frequency Response Pulse trains to 10 MHz Minimum Pulse Width: 50 ns Pulse Rise Time: <200 ns	HP 547A	T
Logic Clip	TTL voltage and current drive levels	HP 548A	T
Cable †	Frequency Range: 10 MHz to 22 GHz Maximum SWR: <1.4 at 22 GHz Length: ≥91 cm (36 in) Connectors: APC 3.5 (m) both ends Maximum Insertion Loss 2 dB (2 required)	8120-4921	P,A
Cable	Frequency Range: 50 MHz to 7 GHz Length: ≥91 cm (36 in) Connectors: SMA (m) both ends	5061-5458	P,A,T
Cable	Frequency Range: dc to 1 GHz Length: ≥91 cm (36 in) Connectors: BNC (m) both ends (4 required)	HP 10503A	P,A,T
* P = Performance Test, A = Adjustment, T=Troubleshooting			
† Option 026 Frequency Range: 10 MHz to 26.5 GHz			

**4-6 Verifying Specified Operation for the HP 8593A**

**Table 4-3. Recommended Test Equipment (continued)**

Instrument	Critical Specifications for Equipment Substitution	Recommended Model	Use*
Cable	Frequency Range: dc to 310 MHz Length: 20 cm (9 in) Connectors: BNC (m) both ends	HP 10502A	P,A,T
Test Cable	Length: $\geq 91$ cm (36 in) Connectors SMB (f) to BNC (m) (2 required)	85680-60093	A,T
Cable Assembly	Length: approximately 15 cm (6 in) Connectors: BNC (f) to Alligator Clips	8120-1292	A
Cable Assembly	Length: $\geq 91$ cm (36 in) Connectors: Banana Plug to Alligator Clips	HP 11102A	A
Adapter	Type N (f) to Type N (f)	1250-1472	P,A,T
Adapter	Type N (m) to BNC (f) (4 required)	1250-1476	P,A,T
Adapter	Type N (m) to BNC (m)	1250-1473	P,A,T
Adapter	Type N (f) to BNC (m)	1250-1477	P,A,T
Adapter	Type N (f) to SMA (f)	1250-1772	P,A,T
Adapter	Type N (m) to APC 3.5 (m)	1250-1743	P,A,T
Adapter	Type N (f) to APC 3.5 (f)	1250-1745	P,A,T
Adapter	APC 3.5 (f) to APC 3.5 (f)	5061-5311	P,A,T
Adapter	Type N (m) to APC 3.5 (f)	1250-1744	P,A,T
Adapter	SMA (f) to SMA (f)	1250-1158	P,A,T
Adapter	SMA (m) to SMA (m)	1250-1159	P,A,T
Adapter	SMB (m) to SMB (m)	1250-0813	A,T
Adapter	BNC (m) to BNC (m)	1250-0216	P,A,T
Adapter	SMC (m) to SMC (m)	1250-0827	A,T
Adapter	BNC tee (m)(f)(f)	1250-0781	T
Adapter	BNC (f) to SMB (m)	1250-1237	A,T

\* P = Performance Test, A = Adjustment, T=Troubleshooting

---

# 1. 10 MHz Reference Accuracy (Standard Timebase)

## Specification

Frequency:

$<\pm 1 \times 10^{-7}/\text{day}$ .

Stability:

$<\pm 0.5 \times 10^{-6}$ .

## Related Adjustment

10 MHz Reference Adjustment (Standard Reference).

---

### Note



If the spectrum analyzer has Option 004, Precision Frequency Reference installed, perform verification test number 20, "10 MHz Reference Output Accuracy (Option 004)," instead.

---

## Description

A frequency counter, which is locked to a 10 MHz reference, is connected to the CAL OUT. This yields better effective resolution. Two frequency measurements are made 24 hours apart. The difference between the two frequencies is calculated and compared to specification.

The stability is measured by changing the setting of the digital-to-analog converter (DAC) which controls the frequency of the timebase. The frequency difference per DAC step is calculated and compared to the specification.

## Equipment

Frequency Counter ..... HP 5343A  
Frequency Standard: any 10 MHz Frequency Standard with aging rate  
of  $<\pm 1 \times 10^{-9}$  per day, such as the HP 5061B

### Cable

BNC Cable, 122 cm (48 in) (2 required) ..... HP 10503A

---

### Note



The spectrum analyzer must have been stored at room temperature for at least two hours and then allowed to warm up for at least 30 minutes at room temperature before performing this test. Also, the analyzer must remain on at room temperature for the duration of this test.

---

### Note



The test results will be invalid if REF UNLK is displayed at any time during this test. REF UNLK will be displayed if the internal reference oscillator is unlocked to the 10 MHz reference. A REF UNLK might occur if there is a hardware failure or if the jumper between 10 MHz REF OUTPUT and EXT REF IN on the rear panel is removed.

---

## 1. 10 MHz Reference Accuracy (Standard Timebase)

### Procedure

1. Connect the equipment as shown in Figure 4-1.

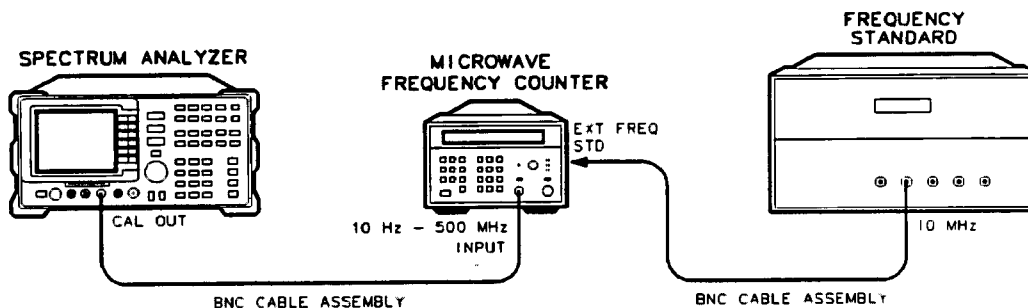

**Figure 4-1. 10 MHz Reference Accuracy Test Setup (Standard Reference)**

2. Set the frequency counter controls as follows:

SAMPLE RATE .....	Midrange
50Ω/1Ω SWITCH .....	50Ω
10Hz-500MHz/500MHz-26.5GHz SWITCH .....	10Hz-500MHz
FREQUENCY STANDARD (Rear panel) .....	EXTERNAL

3. Wait for the frequency counter reading to settle. Record the frequency counter reading here to one Hz resolution:

Reading 1 \_\_\_\_\_ Hz

4. Wait 24 hours before proceeding with the next step. Other performance tests may be run during this 24 hour period under the following conditions:
  - a. The analyzer is powered on at all times.
  - b. The analyzer is always at room temperature.
  - c. The jumper between 10 MHz REF OUTPUT and EXT REF IN on the rear panel is always present.

The CAL OUT may be disconnected from the frequency counter during the 24 hour waiting period.

5. Reconnect the CAL OUT to the 10Hz-500MHz input of the frequency counter, if necessary, and wait for the reading to settle. Record the frequency counter reading here to one Hz resolution.

Reading 2 \_\_\_\_\_ Hz

**1. 10 MHz Reference Accuracy (Standard Timebase)**

6. Subtract Reading 2 (step 5) from Reading 1 (step 3) and record the result below as the Frequency Drift.

Frequency Drift \_\_\_\_\_ Hz

7. Calculate the aging by dividing the frequency drift by 300 MHz. The aging should be less than  $\pm 1 \times 10^{-7}$ .

$$\text{Aging} = \text{Frequency Drift} / 300 \times 10^6$$

Aging \_\_\_\_\_

8. On the spectrum analyzer, press:

**FREQUENCY** -37 **Hz**

**CAL** MORE 1 of 3 MORE 2 of 3 **VERIFY TIMEBASE**.

9. Record the number in the active function block here.

Timebase DAC Setting \_\_\_\_\_

10. Add one to the Timebase DAC Setting recorded in step 9 and enter this number using the number keypad. For example, if the timebase DAC setting is 105, press 1, 0, 6, **Hz**. Wait for the frequency counter reading to settle and record the reading here to one Hertz resolution.

Reading 3 \_\_\_\_\_ Hz

11. Subtract one from the Timebase DAC Setting recorded in step 9 and enter this number using the number keypad. For example, if the timebase DAC setting is 105, press 1, 0, 4, **Hz**. Wait for the frequency counter reading to settle and record the reading here to one Hertz resolution.

Reading 4 \_\_\_\_\_ Hz

12. Calculate the frequency difference between Reading 3 and Reading 2 and between Reading 4 and Reading 2. Record the difference with the greatest absolute value below as the frequency settability.

Frequency Settability \_\_\_\_\_ Hz



**1. 10 MHz Reference Accuracy (Standard Timebase)**

13. Calculate the settability by dividing the frequency settability by 300 MHz and record the result below. The settability should be less than  $\pm 0.5 \times 10^{-6}$ .

$$\text{Settability} = \text{Frequency Settability} / 300 \times 10^{-6}.$$

Settability \_\_\_\_\_

Press **PRESET** on the spectrum analyzer. The timebase DAC will be reset automatically to the value recorded in step 9.

## 2. Comb Generator Frequency Accuracy

### Specification

$<\pm 0.007\%$ .

### Related Adjustment

Comb Generator Frequency Adjustment.

### Description

A 100 MHz signal from a synthesized source and the output from a comb generator are applied to the input of the HP 8593A. The source frequency is adjusted until the two signals appear at the same frequency. The frequency setting of the source is then equal to the comb generator frequency and this frequency is compared to the specification.

### Equipment

Synthesized Sweeper ..... HP 8340A/B  
Power Splitter ..... HP 11667B

### Cables

APC mm (m) 91 cm (36 in) ..... 8120-4921  
SMA Cable 61 cm (18 in) (m) to (m) ..... 8120-1578

### Adapters

Type N (m) to APC 3.5 (m) ..... 1250-1743  
3.5 mm (f) to 3.5 mm (f) ..... 5061-5311

### Procedure

1. Connect the equipment as shown in Figure 4-2. *Option 026:* Omit the Type N to APC adapter.

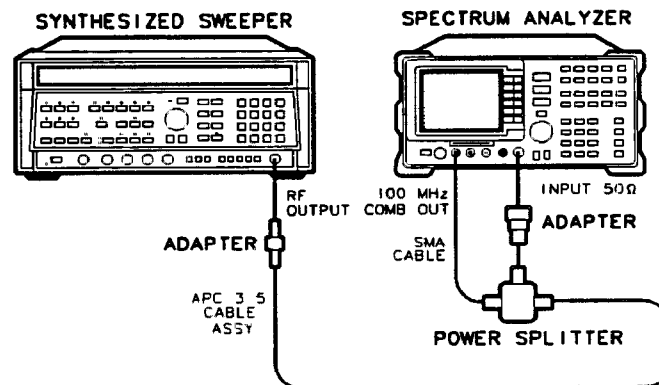

Figure 4-2. Comb Generator Frequency Accuracy Test Setup

## 2. Comb Generator Frequency Accuracy

2. Press **INSTR PRESET** on the HP 8340A/B and set the controls as follows:  
CW ..... 100.025 MHz  
POWER LEVEL ..... 0 dBm  
RF ..... OFF
3. Press **PRESET** on the HP 8593A (wait for PRESET to complete) and set the center frequency as follows:  
CENTER FREQUENCY ..... 100 MHz  
Press **AUX CTRL**, and set the controls as follows:  
COMB GEN ..... ON  
SPAN ..... 10 MHz  
REF LEVEL ..... +10 dB  
RES BW ..... 10 kHz
4. On the HP 8593A, press **PEAK SEARCH**, **SIGNAL TRACK** (ON), **SPAN**, 100 **kHz**. Press **AMPLITUDE** and adjust the reference level setting until the signal peak is 10 dB below the reference level.
5. Set the HP 8340A/B RF on. Adjust the HP 8340A/B power level until the two signals are the same amplitude.
6. Set the HP 8593A LOG dB/DIV to 2 dB.
7. If necessary, readjust the HP 8340A/B power level until the two signals are the same amplitude.
8. Set the HP 8340A/B CW to 100 MHz. A very unstable signal will probably appear. The peak amplitude should be at least 3 dB greater in amplitude than either of the individual signals.
9. Adjust the HP 8340A/B CW setting until a single signal appears to rise and fall in amplitude at the slowest rate (1 Hz frequency resolution will be necessary). The signal peak should be displayed approximately 6 dB above the amplitude of the individual signals.
10. Record the HP 8340A/B CW frequency setting. The frequency should be between 99.993 MHz and 100.007 MHz.

Comb Generator Frequency \_\_\_\_\_ MHz

---

### 3. Frequency Readout Accuracy and Marker Count Accuracy

#### Specification

Frequency Readout Accuracy:

$\pm(\text{Frequency Readout} \times \text{Frequency Reference Accuracy} + 3\% \text{ of SPAN setting} + 20\% \text{ of RES BW setting} + 1.5 \text{ kHz}).$

Marker Count Accuracy:

Spans  $\leq 10$  MHz

$\pm(\text{Marker Frequency} \times \text{Frequency Reference Accuracy} + \text{Counter Resolution} + 100 \text{ Hz}).$

Spans  $> 10$  MHz

$\pm(\text{Marker Frequency} \times \text{Frequency Reference Accuracy} + \text{Counter Resolution} + 1000 \text{ Hz}).$

#### Related Adjustment

Sampler Match Adjustment.

Frequency Reference Adjustment.

#### Description

The frequency readout accuracy of the HP 8593A is tested with an input signal of known frequency. By using the same frequency standard for the analyzer and the synthesized sweeper, the frequency reference error is eliminated.

#### Equipment

Synthesized Sweeper ..... HP 8340A/B

#### Adapters

Type N (m) to APC 3.5 (f) ..... 1250-1744  
3.5 mm (f) to 3.5 mm (f) ..... 5061-5311

#### Cables

APC 3.5, 91 cm (36 in) ..... 8120-4921  
BNC, 122 cm (48 in) ..... HP 10503A

#### Additional Equipment for Option 026

Adapter, 3.5 mm (f) to 3.5 mm (f) ..... 5061-5311

### 3. Frequency Readout Accuracy and Marker Count Accuracy

#### Procedure

#### Frequency Readout Accuracy

1. Connect the equipment as shown in Figure 4-3. Connect the 10 MHz REF OUT of the HP 8340A/B to the EXT REF IN of the analyzer. *Option 026:* Use the 3.5 mm adapter to connect the cable to the analyzer input.

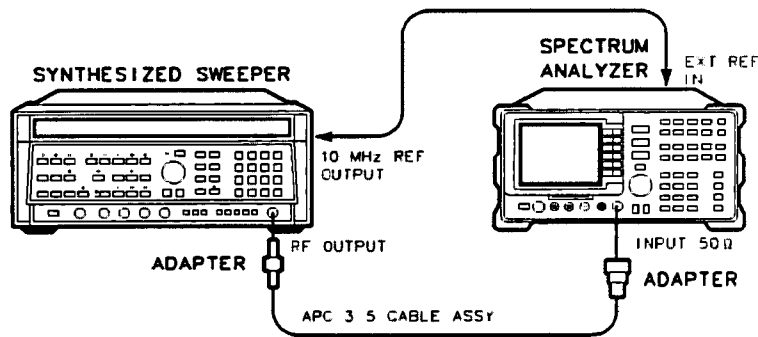

Figure 4-3. Frequency Readout Accuracy Test Setup

2. Press **INSTR PRESET** on the HP 8340A/B and set the controls as follows:  
CW ..... 1.5 GHz  
POWER LEVEL ..... -10 dBm
3. Press **PRESET** on the HP 8593A and wait for the preset to finish. Set the controls as follows:  
CENTER FREQUENCY ..... 1.5 GHz  
SPAN ..... 20 MHz
4. On the HP 8593A, press **PEAK SEARCH**. Record the MKR frequency reading in Table 4-4. The reading should be within the limits shown.
5. Repeat step 4 for the HP 8340A/B CW and HP 8593A center frequency and span combinations listed in Table 4-4.

### 3. Frequency Readout Accuracy and Marker Count Accuracy

Table 4-4. Frequency Readout Accuracy

8340A/B CW Frequency (MHz)	HP 8593A Span (MHz)	HP 8593A Center Frequency (GHz)	Min Frequency (GHz)	Actual Frequency (GHz)	Max Frequency (GHz)
1500	20	1.5	1.49940		1.50060
1500	10	1.5	1.49970		1.50030
1500	1	1.5	1.499967		1.500034
4000	20	4.0	3.99940		4.00060
4000	10	4.0	3.99970		4.00030
4000	1	4.0	3.999967		4.000034
9000	20	9.0	8.99940		9.00060
9000	10	9.0	8.99970		9.00030
9000	1	9.0	8.999967		9.000034
16000	20	16.0	15.99940		16.00060
16000	10	16.0	15.99970		16.00030
16000	1	16.0	15.999967		16.000034
21000	20	21.0	20.99940		21.00060
21000	10	21.0	20.99970		21.00030
21000	1	21.0	20.999967		21.000034

#### Marker Count Accuracy

- On the HP 8593A, press **(MKR)**, MKR CNT ON OFF (ON), MORE 1 of 2, CNT RES AUTO MAN, 10 **(Hz)**.
- Set the HP 8593A resolution bandwidth to 300 kHz.
- Key in the 8340A/B CW frequencies and HP 8593A CENTER FREQUENCIES as indicated in Table 4-5. For each pair of settings, press **(PEAK SEARCH)** and wait for the count to be taken (it may take several seconds). Record the CNT frequency in Table 4-5. The CNT frequency reading should be within the limits shown.

### 3. Frequency Readout Accuracy and Marker Count Accuracy

Table 4-5. Marker Count Accuracy

HP 8340A/B CW Frequency	HP 8593A Center Frequency	HP 8593A Span	CNT MKR Frequency		
			Min (GHz)	Actual (GHz)	Max (GHz)
1500	1.5	20	1.49999899		1.50000101
1500	1.5	1	1.49999989		1.50000011
4000	4.0	20	3.99999899		4.00000101
4000	4.0	1	3.99999989		4.00000011
9000	9.0	20	8.99999899		9.00000101
9000	9.0	1	8.99999989		9.00000011
16000	16.0	20	15.99999899		16.00000101
16000	16.0	1	15.99999989		16.00000011
21000	21.0	20	20.99999899		21.00000101
21000	21.0	1	20.99999989		21.00000011

## 4. Noise Sidebands

### Specification

$< -95 \text{ dBc/Hz} + 20 \log N$  at  $>30 \text{ kHz}$  offset from CW signal, where  $N$  is the desired harmonic of the 1st LO.

### Description

A 500 MHz CW signal is applied to the input of the spectrum analyzer. The marker functions are used to measure the amplitude of the carrier and the noise level 30 kHz above and below the carrier. The difference between these two measurements is compared to specification.

### Equipment

Signal Generator ..... HP 8640B

#### Cable

Type N, 183 cm (72 in) ..... HP 11500A

### Additional Equipment for Option 026

Adapter, APC 3.5 (f) to N (f) ..... 1250-1745

### Procedure

1. Set the HP 8640B controls as follows:

FREQUENCY .....	500 MHz
OUTPUT LEVEL .....	0 dBm
AM .....	OFF
FM .....	OFF
COUNTER .....	INT
RF .....	ON

2. Connect the equipment as shown in Figure 4-4. *Option 026:* Use the APC adapter to connect the cable to the analyzer input.

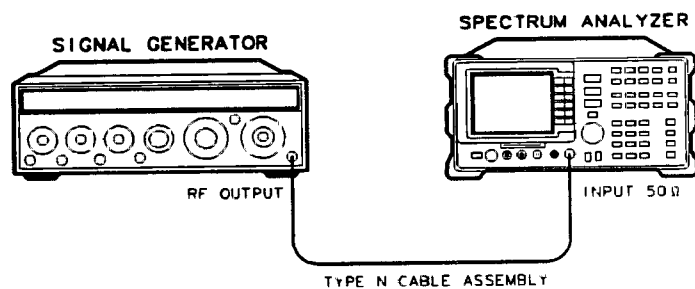

Figure 4-4. Noise Sidebands Test Setup



#### 4. Noise Sidebands

3. Press **PRESET** on the HP 8593A and wait for the preset to finish. Set the controls as follows:

CENTER FREQUENCY ..... 500 MHz  
SPAN ..... 10 MHz

4. On the 8593A, press the following analyzer keys:

**PEAK SEARCH** **SIGNAL TRACK** (ON)  
**SPAN** 200 **kHz**  
**BW** RES BW AUTO MAN 1 **kHz**  
VID BW AUTO MAN 30 **Hz**  
**SIGNAL TRACK** (OFF) **SGL SWP** **PEAK SEARCH**.

5. Record the MKR amplitude reading as the Carrier Amplitude.

Carrier Amplitude \_\_\_\_\_ dBm

6. Press the following analyzer keys:

**MARKER DELTA** 30 **kHz**  
**MKR** **MARKER NORMAL**.

Record the MKR amplitude reading as the Noise Sideband Level at +30 kHz.

Noise Sideband Level at +30 kHz \_\_\_\_\_ dBm

7. Press **PEAK SEARCH**, **MARKER DELTA**, -30 **kHz**, **MKR**, **MARKER NORMAL**. Record the MKR amplitude reading as the Noise Sideband Level at -30 kHz.

Noise Sideband Level at -30 kHz \_\_\_\_\_ dBm

8. Record the more positive value from steps 6 and 7 above and record as the Maximum Noise Sideband Level.

Maximum Noise Sideband Level \_\_\_\_\_ dBm

9. Subtract the Carrier Amplitude (step 5) from the Maximum Noise Sideband Level (step 8) and record as the Noise Sideband Suppression. The suppression should be <-65 dBc.

Noise Sideband Suppression = Maximum Noise Sideband Level - Carrier Amplitude

Noise Sideband Suppression \_\_\_\_\_ dBc

#### 4. Noise Sidebands

---

**Note**

The resolution bandwidth is normalized to 1 Hz as follows: 1 Hz noise-power = (noise-power in dBc) - (10 × log(RBW)).

For example, -65 dBc in a 1 kHz resolution bandwidth is normalized to -95 dBc/Hz.

---

## 5. System Related Sidebands

### Specification

$< -65 \text{ dBc/Hz} + 20 \log N$  at  $>30 \text{ kHz}$  from CW signal, where  $N$  is the desired harmonic of the 1st LO.

### Description

A 500 MHz CW signal is applied to the input of the spectrum analyzer. The marker functions are used to measure the amplitude of the carrier and the amplitude of any system related sidebands 30 kHz above and below the carrier. System related sidebands are any internally generated, line related, power supply related or local oscillator related sidebands.

### Equipment

Signal Generator ..... HP 8640B

### Cable

Cable, Type N, 183 cm (72 in) ..... HP 11500A

### Additional Equipment for Option 026

Adapter, APC 3.5 (f) to N (f) ..... 1250-1745

### Procedure

1. Set the HP 8640B controls as follows:

FREQUENCY .....	500 MHz
OUTPUT LEVEL .....	0 dBm
AM .....	OFF
FM .....	OFF
COUNTER .....	INT
RF .....	ON

2. Connect the equipment as shown in Figure 4-5. *Option 026:* Use the APC adapter to connect the cable to the analyzer input.

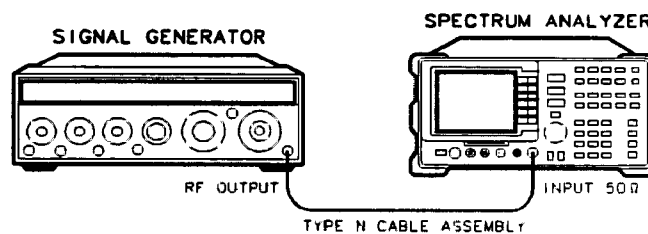

Figure 4-5. System Related Sidebands Test Setup

## 5. System Related Sidebands

3. Press **PRESET** on the analyzer and wait for the preset to finish. Set the controls as follows:

CENTER FREQUENCY ..... 500 MHz  
SPAN ..... 10 MHz

4. On the analyzer, press the following analyzer keys:

**PEAK SEARCH** **SIGNAL TRACK** (ON)  
**SPAN** 200 (kHz)  
**BW** 1 (kHz)  
VID BW AUTO MAN 30 (Hz)  
**SIGNAL TRACK** (OFF)  
**FREQUENCY** CF STEP AUTO MAN 130 (kHz).

5. On the analyzer, press **SGL SWP** and wait for the completion of the sweep. Press **PEAK SEARCH**, **MARKER DELTA**.

6. On the analyzer, press the following analyzer keys:

**FREQUENCY** **▲** (step-up key) **SGL SWP**.

7. Wait for the completion of a new sweep. Press **PEAK SEARCH**. Record the Marker  $\Delta$  Amplitude.

Marker  $\Delta$  Amplitude \_\_\_\_\_ dBc

The marker  $\Delta$  amplitude above the signal should be  $< -65$  dB.

8. On the analyzer, press the following analyzer keys:

**▼** (step-down key) **▼** (step-down key)  
**SGL SWP**.

9. Wait for the completion of a new sweep. Press **PEAK SEARCH**. Record the Marker  $\Delta$  Amplitude.

Marker  $\Delta$  Amplitude \_\_\_\_\_ dBc

The marker  $\Delta$  amplitude below the signal should be  $< -65$  dB.

## 6. Residual FM

### Specification

<400 Hz × N peak to peak in 100 ms.

### Description

This test measures the inherent short-term instability of the spectrum analyzer's LO system. With the analyzer in zero span, a stable signal is applied to the input and slope-detected on the linear portion of the IF bandwidth filter skirt. Any instability in the LO transfers to the IF signal in the mixing process. The test determines the slope of the IF filter in Hz/dB and then measures the signal amplitude variation caused by the residual FM. Multiplying these two values yields the residual FM in Hz.

### Equipment

Synthesized Signal Generator ..... HP 8640B

### Cable

Type N, 183 cm (72 in) ..... HP 11500A

### Additional Equipment for Option 026

Adapter, APC 3.5 (f) to N (f) ..... 1250-1745

### Procedure

#### Determining the IF Filter Slope

1. Connect the equipment as shown in Figure 4-6. *Option 026:* Use the APC adapter to connect the cable to the analyzer input.

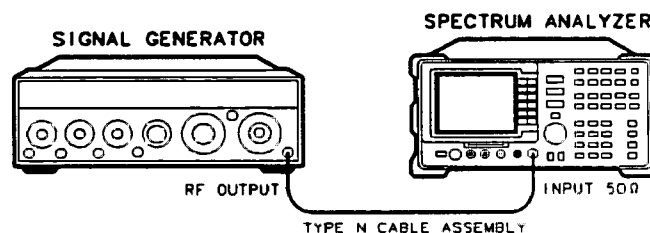

Figure 4-6. Residual FM Test Setup

## 6. Residual FM

2. Set the HP 8640B controls as follows:

FREQUENCY ..... 500 MHz  
CW OUTPUT ..... -10 dBm

3. Press **PRESET** on the HP 8593A and wait for the preset to finish. Set the controls as follows:

CENTER FREQUENCY ..... 500 MHz  
SPAN ..... 1 MHz  
REF LEVEL ..... -9 dBm  
LOG dB/DIV ..... 1 dB  
RES BW ..... 1 kHz

4. On the HP 8593A, press the following keys:

**PEAK SEARCH**  
**SIGNAL TRACK** (ON)  
**SPAN** 10 **kHz**.

Wait for the AUTO ZOOM message to disappear. Press the following analyzer keys:

**MKR ->** **MARKER -> CF**, **MARKER -> REF LVL**  
**SIGNAL TRACK** (OFF)  
**MKR** **MARKERS OFF**.

5. On the HP 8593A, press **SGL SWP**, **PEAK SEARCH**, **MARKER DELTA**.
6. Rotate the HP 8593A knob counterclockwise until the MKR  $\Delta$  amplitude reads -1 dB  $\pm$ 0.1 dB. Press **MARKER DELTA**. Rotate the knob counterclockwise until the MKR  $\Delta$  amplitude reads -4 dB  $\pm$ 0.1 dB.
7. Divide the MKR  $\Delta$  frequency in Hertz by the MKR  $\Delta$  amplitude in dB to obtain the slope of the resolution bandwidth filter. For example, if the MKR  $\Delta$  frequency is 1.08 kHz and the MKR  $\Delta$  amplitude is 3.92 dB, the slope would be equal to 275.5 Hz/dB. Record the result below:

Slope \_\_\_\_\_ Hz/dB

### Measuring the Residual FM

8. On the HP 8593A, press **MKR**, **MARKERS OFF**, **PEAK SEARCH**, and **MARKER DELTA**. Rotate the knob counterclockwise until the MKR  $\Delta$  amplitude reads -3 dB  $\pm$ 0.1 dB.

9. On the HP 8593A, press the following keys:

**MKR** MARKER NORMAL **MKR ->**  
 MARKER -> CF **SGL SWP**  
**SPAN** 0 **Hz**  
**SWEEP** 100 **ms**.

Press **SGL SWP**.

---

**Note**



The displayed trace should be about three divisions below the reference level. If it is not, press **TRIG**, **SWEEP CONT SGL (CONT)**, **FREQUENCY**, and use the knob to place the displayed trace about three divisions below the reference level. Press **SGL SWP**.

---

10. On the HP 8593A, press **MKR**, **MORE 1 of 2**, **PK - PK MEAS**. Read the MKR  $\Delta$  amplitude, take its absolute value, and record the result as the Deviation.

Deviation \_\_\_\_\_ dB

11. Calculate the Residual FM by multiplying the Slope recorded in step 7 by the Deviation recorded in step 10. The residual FM should be less than 400 Hz.

Residual FM \_\_\_\_\_ Hz

---

## 7. Frequency Span Readout Accuracy

### Specification

- ±2% of span, span ≤10 MHz.
- ±3% of span, span >10 MHz, in single band span.

### Related Adjustment

Comb Generator Adjustment.

### Description

For testing spans between 100 kHz and 200 MHz, two synthesized sources are used to provide two precisely-spaced signals. The analyzer's marker functions are used to measure this frequency difference and the marker reading is compared to the specification.

For spans greater than 200 MHz, the analyzer's internal comb generator provides the precisely-spaced signals. Again, the analyzer's marker functions are used to measure the separation of the signals and the marker reading is compared to the specification.

### Equipment

Synthesized Sweeper .....	HP 8340A/B
Synthesizer/Level Generator .....	HP 3335A
Power Splitter .....	HP 11667B

### Adapters

Type N (m) to APC 3.5 (m) .....	1250-1743
3.5 mm (f) to 3.5mm (f) .....	5061-5311
BNC (f) to SMA (m) .....	1250-1200

### Cables

BNC, 122 cm (48 in) .....	HP 10503A
APC 3.5, 91 cm (36 in) .....	8120-4921
Type N (m) to SMA (m) .....	8120-5148

### Additional Equipment for Option 026

Cable, Cal Comb .....	08592-60061
-----------------------	-------------

### Procedure

#### Spans ≥500 MHz

1. Connect the equipment as shown in Figure 4-7. *Option 026:* Use the cal comb with the 3.5 mm adapter.



## 7. Frequency Span Readout Accuracy

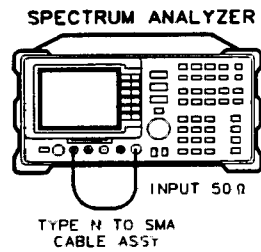

**Figure 4-7. Frequency Span Accuracy Test Setup (Spans  $\geq 500$  MHz)**

2. Press **PRESET** on the HP 8593A and wait for the preset to finish. Set the controls as follows:

CENTER FREQUENCY ..... 10 GHz  
SPAN ..... 500 MHz  
COMB GEN ..... ON

3. Adjust the analyzer's center frequency, if necessary, to place the left-most comb tooth on the second vertical graticule line (one division from the left-most graticule line).
4. Press **PEAK SEARCH**. If necessary, continue pressing **NEXT PEAK** until the marker is on the comb tooth at the second vertical graticule line. This is the "marked" comb tooth.
5. Press **MARKER DELTA** and continue pressing **NEXT PK RIGHT** until the active marker is on the fourth comb tooth to the right of the marked comb tooth.
6. Record the MKR  $\Delta$  frequency reading in Table 4-6. The MKR reading should be within the limits shown.
7. Repeat steps 3 through 6 for the remaining Span settings listed in Table 4-6. For each setting, the right-most marker should be on the Nth comb tooth to the right of the marked comb tooth, where N is given in Table 4-6.

## 7. Frequency Span Readout Accuracy

Table 4-6. Frequency Span Readout Accuracy, Spans  $\geq 500$  MHz

Span Setting	N	MKR $\Delta$ Frequency Reading		
		Min	Actual	Max
500 MHz	4	385.00 MHz	_____	415.00 MHz
1000 MHz	8	770.00 MHz	_____	830.00 MHz
2000 MHz	16	1446.00 MHz	_____	1554.00 MHz

### Spans < 500 MHz

8. Connect the equipment as shown in Figure 4-8. Note that the power splitter is used as a combiner. *Option 026:* Omit the adapter and connect the splitter directly to the analyzer input.

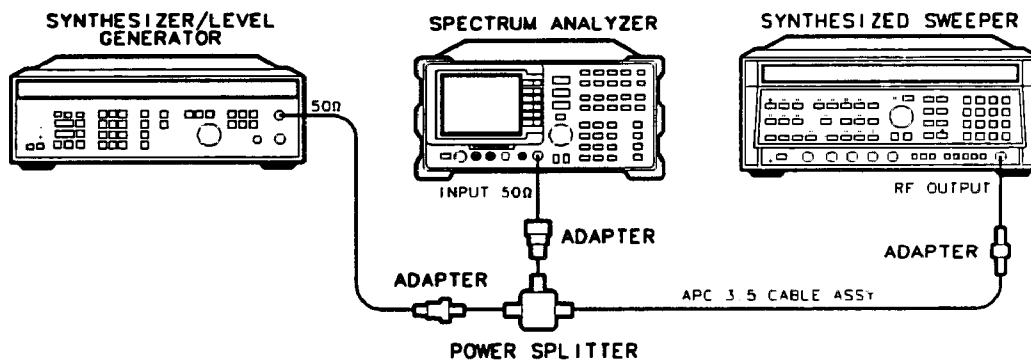

Figure 4-8. Frequency Span Accuracy Test Setup (Spans < 500 MHz)

9. Press **PRESET** on the HP 8593A and wait for the PRESET to finish. Set the control as follows:
- CENTER FREQUENCY ..... 70 MHz  
SPAN ..... 100 MHz
10. Press **INSTR PRESET** on the HP 8340A/B and set the controls as follows:
- CW ..... 110 MHz  
POWER LEVEL ..... -5 dBm
11. Set the HP 3335A controls as follows:
- FREQUENCY ..... 30 MHz  
AMPLITUDE ..... 0 dBm

## 7. Frequency Span Readout Accuracy

12. If necessary, adjust the HP 8593A Center Frequency to center the two signals on the display.
13. On the HP 8593A, press the following keys:

**PEAK SEARCH** **MARKER DELTA** **MARKER DELTA** **NEXT PEAK** .

The two markers should be on the signals near the second and tenth vertical graticule lines (the first graticule line is the left-most).

14. Record the MKR  $\Delta$  frequency reading in Table 4-7. The MKR  $\Delta$  frequency reading should be within the limits shown.
15. Repeat steps 12 through 14 for the remaining Span settings listed in Table 4-7, setting the HP 8340A/B CW and HP 3335A frequency as shown in the table.

**Table 4-7. Frequency Span Readout Accuracy, Spans < 500 MHz**

HP 3335A Frequency	HP 8340A/B Span Setting	HP 8593A Span Setting	MKR $\Delta$ Reading		
			Min	Actual	Max
30.0	110.0	100 MHz	77.0 MHz	_____	83.0 MHz
50.0	90.0	50 MHz	38.5 MHz	_____	41.5 MHz
62.0	78.0	20 MHz	15.40 MHz	_____	16.60 MHz
66.0	74.0	10 MHz	7.80 MHz	_____	8.20 MHz
68.0	72.0	5 MHz	3.900 MHz	_____	4.100 MHz
69.2	70.8	2 MHz	1.560 MHz	_____	1.640 MHz
69.6	70.4	1 MHz	780.0 kHz	_____	820.0 kHz
69.8	70.2	500 kHz	390.0 kHz	_____	410.0 kHz
69.92	70.08	200 kHz	156.0 kHz	_____	164.0 kHz
69.96	70.04	100 kHz	78.0 kHz	_____	82.0 kHz

---

## 8. Sweep Time Accuracy

### Specification

20 ms to 100 s  $\pm 3\%$ .

### Description

This test uses a synthesizer function generator to amplitude modulate a 500 MHz CW signal from another signal generator. The analyzer demodulates this signal in zero span to display the response in the time domain. The marker delta frequency function on the analyzer is used to read out the sweep time.

### Equipment

Synthesizer/Function Generator ..... HP 3325A  
Signal Generator ..... HP 8640B

### Cables

Type N Cable, 152 cm (60 in) ..... HP 11500D  
BNC, 120 cm (48 in.) ..... HP 10503A

### Additional Equipment for Option 026

Adapter, APC 3.5 (f) to N (f) ..... 1250-1745

### Procedure

---

#### Note



For Option 101: Perform verification test number 21, "Fast Time Domain Sweeps (Option 101)," in addition to this test.

---

1. Set the signal generator to output a 500 MHz,  $-10$  dBm, CW signal. Set the AM and FM controls to off.
2. Set the synthesizer function generator to output a 500 Hz,  $+5$  dBm triangle waveform signal.
3. Connect the equipment as shown in Figure 4-9. *Option 026:* Use the APC adapter to connect the cable to the analyzer input.

## 8. Sweep Time Accuracy

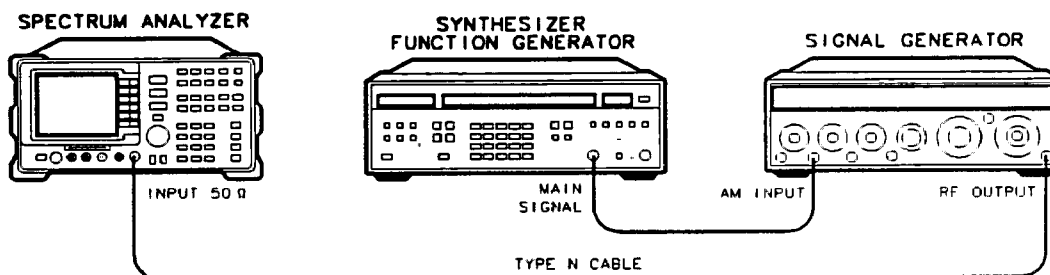

**Figure 4-9. Sweep Time Accuracy Test Setup**

4. Press **PRESET** on the analyzer and wait for the preset to finish. Set the controls as follows:

CENTER FREQUENCY ..... 500 MHz  
SPAN ..... 10 MHz

- Press **PEAK SEARCH**. Set the controls as follows:

SIGNAL TRACK ..... ON  
SPAN ..... 50 kHz

- Wait for the AUTO ZOOM routine to finish. Press **SPAN**, ZERO SPAN.

- Set the controls as follows:

BW ..... 3 MHz  
AMPLITUDE SCALE ..... LINEAR  
SWEEP TIME ..... 20 ms

Adjust signal amplitude for a mid-screen display.

5. Set the signal generator AM switch to the AC position.
6. On the analyzer, press the following keys:  
**TRIG** **VIDEO**.
- Adjust the video trigger so that the analyzer is sweeping.
7. Press **SGL SWP**. After the completion of the sweep, press **PEAK SEARCH**. If necessary, press **NEXT PEAK** until the marker is on the left most signal. This is the "marked signal."
8. Press **MARKER DELTA**, **MARKER DELTA** and press **NEXT PK RIGHT** until the marker delta is on the eighth signal peak. Record the marker  $\Delta$  reading in Table 4-8.
9. Repeat steps 6 through 9 for the remaining sweep time settings listed in Table 4-8.

## 8. Sweep Time Accuracy

Table 4-8. Sweep Time Accuracy

HP 8593A Sweep Time Setting	HP 3325A Frequency	Minimum Reading	MKR $\Delta$	Maximum Reading
20 ms	500 Hz	15.4 ms	_____	16.6 ms
50 ms	200 Hz	38.5 ms	_____	41.5 ms
100 ms	100 Hz	77.0 ms	_____	83.0 ms
500 ms	20 Hz	385.0 ms	_____	415.0 ms
1 s	10 Hz	770.0 ms	_____	830.0 ms
10 s	1 Hz	7.7 s	_____	8.3 s
50 s	0.2 Hz	38.5 s	_____	41.5 s
100 s	0.1 Hz	77.0 s	_____	83.0 s

## 9. Scale Fidelity

### Specification

#### Log Mode:

- ±0.2 dB/2 dB, 0 to -70 dB from Reference Level range.
- ±0.75 dB maximum over 0 to -60 dB from Reference Level.
- ±1.0 dB maximum over 0 to -70 dB from Reference Level.

#### Linear Mode:

- <±3% of Reference Level.

#### Log to Linear Switching Uncertainty:

- ±0.25 dB at the Reference Level.

### Related Adjustment

- A12 Cal Attenuator Error Correction Adjustment.
- Log and Linear Amplitude Adjustment.

### Description

A 50 MHz CW signal is applied to the INPUT 50Ω of the analyzer through two step attenuators. The attenuators increase the effective amplitude range of the source. The amplitude of the source is decreased in 10 dB steps and the analyzer marker functions are used to measure the amplitude difference between steps. The source's internal attenuator is used as the reference standard. The test is performed in both log and linear amplitude scales.

### Equipment

- Synthesizer/Level Generator ..... HP 3335A
- Step Attenuator, 1 dB steps ..... HP 355C
- Step Attenuator, 10 dB steps ..... HP 355D

#### Cables

- BNC Cable 23 cm (9 in) ..... HP 10502A
- BNC Cable 122 cm (48 in) (2 required) ..... HP 10503A

#### Adapter

- Type N (m) to BNC (f) ..... 1250-1476

### Additional Equipment for Option 026

- Adapter, 3.5 mm (f) to 3.5 mm (f) ..... 5061-5311
- Adapter, BNC (f) to SMA (m) ..... 1250-1200

## 9. Scale Fidelity

### Procedure

#### Log Scale

1. Set the HP 3335A controls as follows:

FREQUENCY ..... 50 MHz  
AMPLITUDE ..... +10 dBm  
AMPTD INCR ..... 0.05 dB  
OUTPUT ..... 50Ω

2. Connect the equipment as shown in Figure 4-10. (*Option 026*: use the BNC to SMA and 3.5 mm adapters instead of the type N to BNC adapter). Set the HP 355D to 10 dB attenuation and the 355C to 0 dB attenuation.

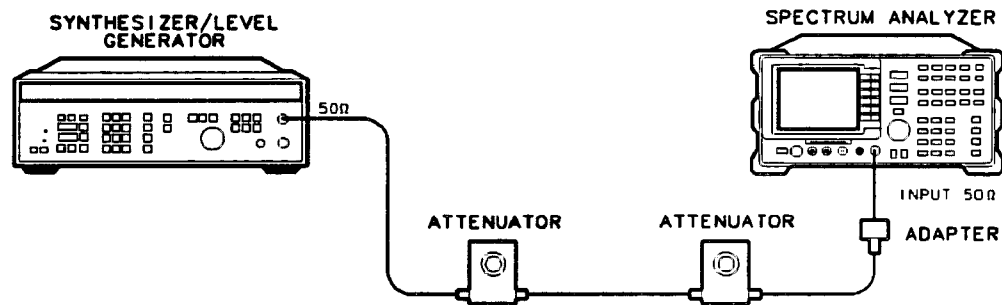

Figure 4-10. Scale Fidelity Test Setup

3. Press **PRESET** on the analyzer and wait for the preset to finish. Set the controls as follows:

CENTER FREQUENCY ..... 50 MHz  
SPAN ..... 10 MHz

4. On the analyzer, press the following keys:

**PEAK SEARCH** **SIGNAL TRACK** (ON)  
**SPAN** 50 **kHz**.

After the auto zoom procedure is finished, set the resolution bandwidth to 3 kHz and the video bandwidth to 30 Hz.

5. If necessary, adjust the HP 355C attenuation until the MKR amplitude reads between 0 dBm and -1 dBm.
6. On the HP 3335A, press **AMPLITUDE** and use the INCR keys to adjust the amplitude until the analyzer MKR amplitude reads 0 dBm  $\pm$ 0.05 dB.



**Note**

It may be necessary to decrease the resolution of the amplitude increment of the HP 3335A to 0.01 dB to obtain a MKR reading of 0 dBm  $\pm$ 0.05 dB.

7. On the analyzer, press **PEAK SEARCH**, **MARKER DELTA**.
8. Set the HP 3335A AMPTD INCR to 2 dB.
9. On the HP 3335A, press **AMPLITUDE** and **INCR** (down) to step the HP 3335A to the next lowest nominal amplitude listed in Table 4-9. Record the MKR  $\Delta$  amplitude reading in Table 4-9. The MKR amplitude should be within the limits shown.
10. Repeat step 9 for the remaining HP 3335A Nominal Amplitudes listed in Table 4-9.
11. For each MKR  $\Delta$  reading, subtract the previous MKR  $\Delta$  reading. Add 2 dB to the number and record the result as the incremental error in Table 4-9. The incremental error should not exceed 0.2 dB/2 dB.

**Table 4-9. Incremental Error, Log Mode**

HP 3335A Nominal Amplitude	dB from Ref Level (nominal)	MKR $\Delta$ Reading			Incremental Error (dB)
		Min (dB)	Actual (dB)	Max (dB)	
+10 dBm	0	0 (Ref)	0 (Ref)	0 (Ref)	0 (Ref)
+8 dBm	-2	-2.2	_____	-1.8	_____
+6 dBm	-4	-4.4	_____	-3.6	_____
+4 dBm	-6	-6.6	_____	-5.4	_____
+2 dBm	-8	-8.75	_____	-7.25	_____
0 dBm	-10	-10.75	_____	-9.25	_____

**Scale Fidelity, Log Mode**

12. Set the HP 3335A AMPTD INCR to 10 dB.
13. On the HP 3335A, press **INCR** (up).
14. On the HP 3335A, press **INCR** (down) to step the HP 3335A to the next lowest nominal amplitude listed in Table 4-10. Record the MKR  $\Delta$  amplitude reading in Table 4-10. The MKR amplitude should be within the limits shown.
15. Repeat step 14 for the remaining HP 3335A Nominal Amplitudes listed in Table 4-10.

9. Scale Fidelity

Table 4-10. Scale Fidelity, Log Mode

HP 3335A Nominal Amplitude	dB From Reference Level (nominal)	MKR Δ Reading		
		Min (dB)	Actual (dB)	Max (dB)
+10 dBm	0	0 (Ref)	0 (Ref)	0 (Ref)
0 dBm	-10	-10.75	_____	-9.25
-10 dBm	-20	-20.75	_____	-19.25
-20 dBm	-30	-30.75	_____	-29.25
-30 dBm	-40	-40.75	_____	-39.25
-40 dBm	-50	-50.75	_____	-49.25
-50 dBm	-60	-60.75	_____	-59.25
-60 dBm	-70	-71.00	_____	-69.00

Linear Scale

16. Set the HP 3335A controls as follows:

AMPLITUDE ..... +10 dBm  
 AMPTD INCR ..... 0.05 dB

17. Set the 355C to 0 dB attenuation.

18. Press **PRESET** on the analyzer and wait for the preset to finish. Press **AMPLITUDE**,  
 SCALE LOG LIN (LIN).

Set the controls as follows:

FREQUENCY ..... 50 MHz  
 SPAN ..... 10 MHz

19. On the analyzer, press the following keys:

**PEAK SEARCH** **SIGNAL TRACK** (ON)  
**SPAN** 50 **kHz**.

After the auto zoom procedure is finished, set the resolution bandwidth to 3 kHz and video bandwidth to 30 Hz.

20. If necessary, adjust the HP 355C attenuation until the MKR reads approximately 223.6 mV.

**Note**



It may be necessary to decrease the resolution of the amplitude increment of the HP 3335A to 0.01 dB to obtain a MKR reading of 223.6 mV ± 0.4 mV.

21. On the HP 3335A, press **AMPLITUDE** and use the INCR keys to adjust the amplitude until the analyzer MKR amplitude reads 223.6 mV ±0.4 mV.
22. On the analyzer, press **PEAK SEARCH**.
23. Set the HP 3335A amplitude increment to 3 dB.
24. On the HP 3335A, press **AMPLITUDE** and **INCR ▼** (step-down key) to step the HP 3335A to the next lowest Nominal Amplitude listed in Table 4-11.  
Record the MKR amplitude reading in Table 4-11. The MKR amplitude should be within the limits shown.
25. Repeat step 9 for the remaining HP 3335A Nominal Amplitudes listed in Table 4-11.

**Table 4-11. Scale Fidelity, Linear Mode**

HP 3335A Nominal Amplitude	% of Ref Level (nominal)	MKR Reading		
		Min (mV)	Actual (mV)	Max (mV)
+10 dBm	100	0 (Ref)	0 (Ref)	0 (Ref)
+7 dBm	70.7	150.98	_____	165 20
+4 dBm	50	104.69	_____	118 91
+1 dBm	35.48	72.22	_____	86.44
-2 dBm	25	48.79	_____	63.01

**Log to Linear Switching**

26. Set the HP 355D to 10 dB attenuation and the HP 355C to 0 dB attenuation.
27. Set the synthesizer controls as follows:  
 FREQUENCY ..... 50 MHz  
 AMPLITUDE ..... +6 dBm
28. On the spectrum analyzer, press **PRESET** and wait for the preset to complete. Set the control as follows:  
 CENTER FREQ ..... 50 MHz  
 SPAN ..... 10 MHz  
 RES BW ..... 300 kHz
29. On the spectrum analyzer, press **PEAK SEARCH**, **MKR ->**, MKR -> REF LVL ,  
**PEAK SEARCH**, **MARKER DELTA** .
30. Press **AMPLITUDE**, **SCALE LOG LIN (LIN)**, **MORE 1 of 2**, **AMPTD UNITS** , dBm to change the scale to linear and set the amplitude units to dBm.

## 9. Scale Fidelity

31. If the MKR  $\Delta$  amplitude is less than 0 dB, record the MKR  $\Delta$  amplitude reading here. The absolute value of the reading should be less than 0.25 dB. If the MKR  $\Delta$  amplitude is greater than 0 dB, continue with step 32 below.

Log-to-Lin Switching Uncertainty \_\_\_\_\_ dB

32. Press **MKR ->**, MKR -> REF LVL, **PEAK SEARCH**, and MARKER DELTA .
33. Press **AMPLITUDE**, and SCALE LOG LIN to change the scale to LOG 10 dB/DIV.
34. Record the MKR  $\Delta$  amplitude reading here. The absolute value of the reading should be less than 0.25 dB.

Log-to-Lin Switching Uncertainty \_\_\_\_\_ dB

## 10. Input Attenuator Accuracy

### Specification

#### Range:

0 to 70 dB in 10 dB steps.

#### Accuracy:

0 to 60 dB  $\pm 0.5$  dB at 50 MHz referred to 10 dB attenuation.  
70 dB  $\pm 1.2$  dB at 50 MHz referred to 10 dB attenuation.

### Description

The input attenuator's switching accuracy is tested over the full 0 dB to 70 dB range. Switching accuracy is referenced to the 10 dB attenuator setting. The attenuator in the synthesizer/level generator is used as the measurement standard.

### Equipment

Synthesizer/Level Generator .....	HP 3335A
Step Attenuator, 1 dB steps .....	HP 355C
Step Attenuator, 10 dB steps .....	HP 355D

### Cables

BNC Cable 23 cm (9 in) .....	HP 10502A
BNC Cable, 120 cm (48 in) (2 required) .....	HP 10503A

### Adapter

Type N (m) to BNC (f) .....	1250-1476
-----------------------------	-----------

### Additional Equipment for Option 026

Adapter, 3.5 mm (f) to 3.5 mm (f) .....	5061-5311
Adapter, BNC (f) to SMA (m) .....	1250-1200

### Procedure

1. Connect the equipment as shown in Figure 4-11. *Option 026*: Use the BNC to SMA and 3.5 mm adapters instead of the Type N to BNC adapter. Set the HP 355D to 20 dB attenuation and the HP 355C to 0 dB attenuation.

## 10. Input Attenuator Accuracy

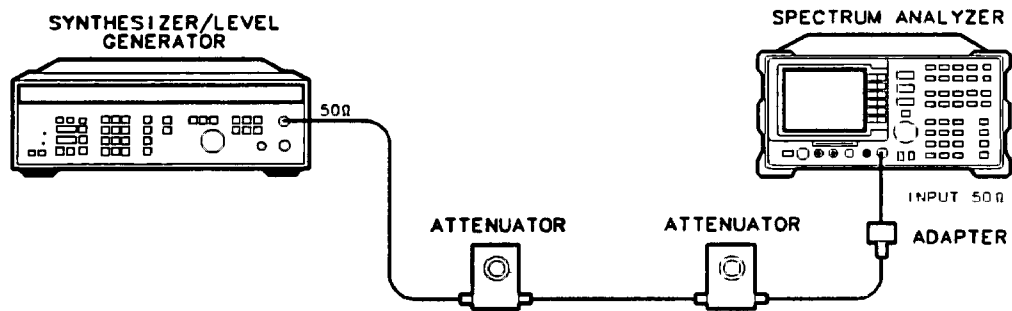

Figure 4-11. Input Attenuator Accuracy Test Setup

2. Set the HP 3335A controls as follows:

FREQUENCY ..... 50 MHz  
 AMPLITUDE ..... -50 dBm  
 AMPTD INCR ..... 10 dB  
 OUTPUT ..... 50Ω

3. On the HP 8593A, press **PRESET** and wait for the preset to finish. Set the controls as follows:

CENTER FREQUENCY ..... 50 MHz  
 SPAN ..... 100 kHz  
 REF LEVEL ..... -70 dBm  
 LOG dB/DIV ..... 1 dB  
 RES BW ..... 10 kHz  
 VIDEO BW ..... 100 Hz

4. Set the HP 355C attenuation to place the signal peak two to three dB (two to three divisions) below the reference level.

5. On the HP 8593A, press the following keys:

**SGL SWP** **PEAK SEARCH** **MARKER DELTA** .

6. Set the HP 3335A amplitude to -60 dBm as indicated in row 2 of Table 4-12.

7. Set the HP 8593A reference level to -80 dBm and attenuation to 0 dB as indicated in row 2 of Table 4-12.

8. On the HP 8593A, press **SGL SWP**, and wait for a new sweep to finish. Press **PEAK SEARCH** and record the MKR Δ amplitude in Table 4-12 as the Actual MKR Δ Reading. The MKR Δ amplitude reading should be within the limits shown.

9. Repeat steps 7 through 10 using the HP 3335A amplitude and HP 8593A ref level and attenuation settings listed in Table 4-12.

10. Input Attenuator Accuracy

Table 4-12. Input Attenuator Accuracy

HP 3335A Amplitude	HP 8593A Reference Level	HP8593A Attenuation (dB)	MKR $\Delta$ Min (dB)	MKR $\Delta$ Actual (dB)	MKR $\Delta$ Max (dB)
-50	-70	10	0 (Ref)	0 (Ref)	0 (Ref)
-60	-80	0	-0.5	_____	+0.5
-40	-60	20	-0.5	_____	+0.5
-30	-50	30	-0.5	_____	+0.5
-20	-40	40	-0.5	_____	+0.5
-10	-30	50	-0.5	_____	+0.5
0	-20	60	-0.5	_____	+0.5
10	-10	70	-1.2	_____	+1.2

---

## 11. Reference Level Accuracy

### Specification

Accuracy Referred to -20 dBm Reference Level:

- 0 to -59.9 dBm  $\pm(0.5 \text{ dB} + \text{Input Attenuator Accuracy at 50 MHz})$ .
- 60 to -112 dBm  $\pm(1.25 \text{ dB} + \text{Input Attenuator Accuracy at 50 MHz})$ .

### Related Adjustment

A12 Cal Attenuator Error Correction Adjustment.

### Description

A 50 MHz CW signal is applied to the INPUT 50 $\Omega$  of the HP 8593A through two step attenuators. The attenuators increase the effective amplitude range of the source. The amplitude of the source is decreased in 10 dB steps and the HP 8593A marker functions are used to measure the amplitude difference between steps. The source's internal attenuator is used as the reference standard. The test is performed in both log and linear amplitude scales.

It is only necessary to test reference levels as low as -90 dBm (with 10 dB ATTEN) since lower reference levels are a function of the HP 8593A's microprocessor manipulating the trace data. There is no error associated with the trace data manipulation.

### Equipment

Synthesizer/ Level Generator .....	HP 3335A
Step Attenuator, 10 dB steps .....	HP 355D
Step Attenuator, 1 dB steps .....	HP 355C

#### Cables

BNC Cable, 23 cm (9 in) .....	HP 10502A
BNC Cable, 122 cm (48 in) (2 required) .....	HP 10503A

#### Adapter

Type N (m) to BNC (f) .....	1250-1476
-----------------------------	-----------

#### Additional Equipment for Option 026

Adapter, 3.5 mm (f) to 3.5 mm (f) .....	5061-5311
Adapter, BNC (f) to SMA (m) .....	1250-1200



**Procedure**

**Log Scale**

1. Set the HP 3335A controls as follows:

FREQUENCY ..... 50 MHz  
 AMPLITUDE ..... -10 dBm  
 AMPTD INCR ..... 10 dB  
 OUTPUT ..... 50Ω

2. Connect the equipment as shown in Figure 4-12. *Option 026:* Use the BNC to SMA and 3.5 mm adapters instead of the Type N to BNC adapter. Set the HP 355D to 10 dB attenuation and the 355C to 0 dB attenuation.

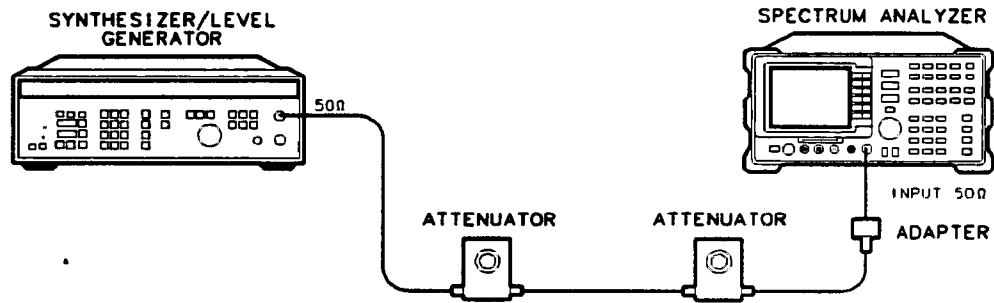

**Figure 4-12. Reference Level Accuracy Test Setup**

3. Press **PRESET** on the HP 8593A and wait for the preset to finish. Set the controls as follows:

CENTER FREQUENCY ..... 50 MHz  
 SPAN ..... 50 kHz  
 REFERENCE LEVEL ..... -20 dBm  
 LOG dB/DIV ..... 1 dB  
 RES BW ..... 3 kHz  
 VIDEO BW ..... 30 Hz

4. Set the HP 355C attenuation to place the signal peak one to two dB (one to two divisions) below the reference level.

5. On the HP 8593A, press the following keys:

**SGL SWP**  
**PEAK SEARCH** MARKER DELTA .

6. Set the HP 3335A amplitude and HP 8593A reference level according to Table 4-13. At each setting, press **SGL SWP** **PEAK SEARCH** on the HP 8593A. Record the MKR Δ amplitude reading in Table 4-13. The MKR Δ reading should be within the limits shown.

11. Reference Level Accuracy

Table 4-13. Reference Level Accuracy, Log Mode

HP 3335A Amplitude (dBm)	HP 8593A Ref Level (dBm)	MKR Δ Reading		
		Min (dB)	Actual (dB)	Max (dB)
-10	-20	0 (Ref)	0 (Ref)	0 (Ref)
0	-10	-0.5	_____	+0.5
+10	0	-0.5	_____	+0.5
-20	-30	-0.5	_____	+0.5
-30	-40	-0.5	_____	+0.5
-40	-50	-0.5	_____	+0.5
-50	-60	-1.25	_____	+1.25
-60	-70	-1.25	_____	+1.25
-70	-80	-1.25	_____	+1.25
-80	-90	-1.25	_____	+1.25

Linear Scale

7. Set the HP 3335A amplitude to -10 dBm.
8. Set the 355C to 0 dB attenuation.
9. Set the HP 8593A controls as follows:
  - REF LEVEL ..... -20 dBm
  - AMPLITUDE SCALE ..... LINEAR
  - AMPTD UNITS ..... dBm
  - SWEEP ..... CONT
10. Set the HP 355C attenuation to place the signal peak one to two divisions below the reference level.
11. On the HP 8593A, press **MKR**, **MARKERS OFF**, **SGL SWP**, **PEAK SEARCH**, **MARKER DELTA**.
12. Set the HP 3335A amplitude and HP 8593A reference level according to Table 4-14. At each setting, press **SGL SWP**, **PEAK SEARCH** on the HP 8593A. Record the MKR Δ amplitude reading in Table 4-14. The MKR Δ reading should be within the limits shown.

## 11. Reference Level Accuracy

13. In Table 4-13, locate the Actual MKR  $\Delta$  Amplitude Reading for the 0 to -50 dBm reference level settings with the greatest deviation (positive or negative) from 0 dB and record below.

Log Mode Reference Level Accuracy \_\_\_\_\_ dB  
(0 to -50 dBm reference level settings)

14. In Table 4-13, locate the Actual MKR  $\Delta$  Amplitude Reading for the 0 to -90 dBm reference level settings with the greatest deviation (positive or negative) from 0 dB and record below.

Log Mode Reference Level Accuracy \_\_\_\_\_ dB  
(0 to -90 dBm reference level settings)

15. In Table 4-14, locate the Actual MKR  $\Delta$  Amplitude Reading for the 0 to -50 dBm reference level settings with the greatest deviation (positive or negative) from 0 dB and record below.

Linear Mode Reference Level Accuracy \_\_\_\_\_ dB  
(0 to -50 dBm reference level settings)

16. In Table 4-14, locate the Actual MKR  $\Delta$  Amplitude Reading for the 0 to -90 dBm reference level settings with the greatest deviation (positive or negative) from 0 dB and record below.

Linear Mode Reference Level Accuracy \_\_\_\_\_ dB  
(0 to -90 dBm reference level settings)

## 11. Reference Level Accuracy

**Table 4-14. Reference Level Accuracy, Linear Mode**

HP 3335A Amplitude (dBm)	HP 8593A Ref Level (dBm)	MKR $\Delta$ Reading		
		Min (dB)	Actual (dB)	Max (dB)
-10	-20	0 (Ref)	0 (Ref)	0 (Ref)
0	-10	-0.5	_____	+0.5
10	0	-0.5	_____	+0.5
-20	-30	-0.5	_____	+0.5
-30	-40	-0.5	_____	+0.5
-40	-50	-0.5	_____	+0.5
-50	-60	-1.25	_____	+1.25
-60	-70	-1.25	_____	+1.25
-70	-80	-1.25	_____	+1.25
-80	-90	-1.25	_____	+1.25

## 12. Resolution Bandwidth Switching Uncertainty

### Specification

$\pm 0.4$  dB for 3 kHz to 3 MHz RES BW settings, referred to 3 kHz RES BW setting.

$\pm 0.5$  dB for 1 kHz RES BW settings, referred to 3 kHz RES BW setting.

### Related Adjustments

Crystal and LC Bandwidth Filter Adjustment.

### Description

For this test, the CAL OUT signal is used as the input signal. An amplitude reference is taken with the resolution bandwidth set to 1 kHz using the marker delta function. The resolution bandwidth is changed to settings between 3 MHz and 1 kHz and the amplitude variation is measured at each setting and compared to the specification. The Span is changed as necessary to maintain approximately the same aspect ratio.

### Equipment

#### Cable

BNC, 23 cm (9 in) ..... HP 10502A

#### Adapter

Type N (m) to BNC (f) ..... 1250-1476

### Additional Equipment for Option 026

Adapter, 3.5 mm (f) to 3.5 mm (f) ..... 5061-5311

Adapter, BNC (f) to SMA (m) ..... 1250-1200

### Procedure

1. Connect the CAL OUT to the spectrum analyzer input using the BNC cable and adapter, as shown in Figure 4-13. *Option 026:* Use the BNC to SMA and 3.5 mm adapters to connect the cable to the analyzer input.

## 12. Resolution Bandwidth Switching Uncertainty

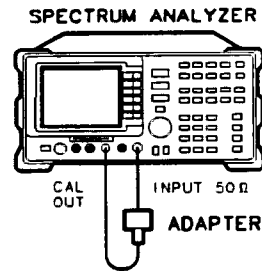

Figure 4-13. Resolution Bandwidth Switching Uncertainty Test Setup

2. Press **PRESET** on the analyzer and wait for the preset to finish. Set the controls as follows:

CENTER FREQUENCY ..... 300 MHz  
SPAN ..... 10 MHz

Press **PEAK SEARCH** and **SIGNAL TRACK** (ON).

Set the controls as follows:

SPAN ..... 50 kHz  
REF LEVEL ..... -20 dBm  
LOG dB/DIV ..... 1 dB  
RES BW ..... 3 kHz  
VIDEO BW ..... 1 kHz

3. Press **AMPLITUDE** and use the knob to adjust the REF LEVEL until the signal appears one division below the reference level. Press **PEAK SEARCH**, **MARKER DELTA**, **SIGNAL TRACK** (ON).
4. Set the resolution bandwidth and span according to Table 4-15.
5. Press **PEAK SEARCH**, then record the MKR  $\Delta$ -TRK amplitude reading in Table 4-15.  
The amplitude reading should be within the limits shown.
6. Repeat steps 4 and 5 for each of the remaining resolution bandwidth and span settings listed in Table 4-15.

## 12. Resolution Bandwidth Switching Uncertainty

**Table 4-15. Resolution Bandwidth Switching Uncertainty**

RES BW Setting	Span Setting	MKR Δ-TRK Amplitude Reading		
		Min (dB)	Actual (dB)	Max (dB)
3 kHz	50 kHz	0 (Ref)	0 (Ref)	0 (Ref)
1 kHz	50 kHz	-0.5	_____	+0.5
10 kHz	50 kHz	-0.4	_____	+0.4
30 kHz	500 kHz	-0.4	_____	+0.4
100 kHz	500 kHz	-0.4	_____	+0.4
300 kHz	5 MHz	-0.4	_____	+0.4
1 MHz	10 MHz	-0.4	_____	+0.4
3 MHz	10 MHz	-0.4	_____	+0.4

---

## 13. Calibrator Amplitude Accuracy

### Specification

Amplitude:

-20 dBm  $\pm$ 0.4 dB

### Related Adjustment

CAL AMPTD Adjustment.

### Description

This test measures the accuracy of the analyzer's CAL OUT signal. The first part of the test characterizes the insertion loss of a Low Pass Filter (LPF) and 10 dB Attenuator. The harmonics of the CAL OUT signal are suppressed with the LPF before the amplitude accuracy is measured using a power meter.

Calibrator Frequency is not included in this procedure because it is a function of the Frequency Reference (CAL OUT Frequency = 300 MHz  $\pm$ (300 MHz  $\times$  Frequency Reference)). Perform the Frequency Reference Accuracy test to verify the CAL OUT frequency.

### Equipment

Synthesized Sweeper .....	HP 8340A/B
Measuring Receiver (used as a power meter) .....	HP 8902A
Power Meter .....	HP 436A
Low Power Sensor with a 50 MHz reference attenuator .....	HP 8484A
Power Sensor .....	HP 8482A
Power Splitter .....	HP 11667A
10 dB Attenuator, Type N (m to f), dc-12.4 GHz Opt 010.....	HP 8491A
Low Pass Filter .....	0955-0455

### Cables

Type N, 152 cm (60 in) .....	HP 11500D
------------------------------	-----------

### Adapters

APC 3.5 (f) to Type N (f) .....	1250-1745
Type N (f) to BNC (m) (2 required) .....	1250-1477
Type N (m) to BNC (f) .....	1250-1476

### Procedure

#### LPF, Attenuator and Adapter Insertion Loss Characterization

1. Zero and calibrate the HP 8902A and HP 8482A in LOG mode as described in the *HP 8902A Operation Manual*.



### 13. Calibrator Amplitude Accuracy

2. Zero and calibrate the HP 436A and HP 8484A, as described in the *HP 436A Operation Manual*.

**Caution**



Do not attempt to calibrate the HP 8484A without the reference attenuator or damage to the HP 8484A will occur.

3. Press **INSTR PRESET** on the HP 8340A/B. Set the controls as follows:

CW .....300 MHz  
 POWER LEVEL ..... -15 dBm

4. Connect the equipment as shown in Figure 4-14. Connect the HP 8484A directly to the power splitter (bypass the LPF, attenuator and adapters).

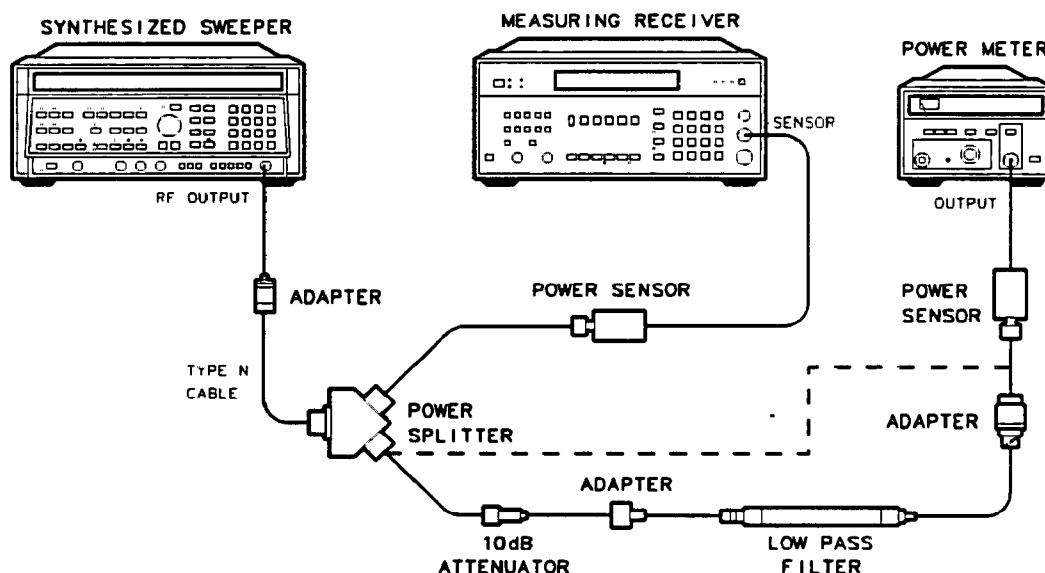

**Figure 4-14. LPF Characterization**

**Note**



Allow the power sensors to settle before proceeding.

5. On the HP 8902A, press **RATIO** mode. Power indication should be zero dB.
6. On the HP 436A, press dB [REF] mode. Power indication should be zero dB.
7. Connect the LPF, attenuator and adapters as shown in Figure 4-14.
8. Record the HP 8902A reading in dB. This is the relative error due to mismatch.

Mismatch Error \_\_\_\_\_dB

### 13. Calibrator Amplitude Accuracy

- Record the HP 436A reading in dB. This is the relative uncorrected insertion loss of the LPF, attenuator and adapters.

Uncorrected Insertion Loss \_\_\_\_\_ dB

- Subtract the Mismatch Error (Step 8) from the Uncorrected Insertion Loss (Step 9). This is the Corrected Insertion Loss.

Corrected Insertion Loss \_\_\_\_\_ dB

Example: If the Mismatch Error is +0.3 dB and the Uncorrected Insertion Loss is -10.2 dB, subtract the Mismatch Error from the insertion loss to yield a corrected reading of -10.5 dB.

### Calibrator Amplitude Accuracy

- Connect the equipment as shown in Figure 4-15. The analyzer should be positioned so that the setup of the adapters, LPF and attenuator do not bind. It may be necessary to support the center of gravity of the devices.

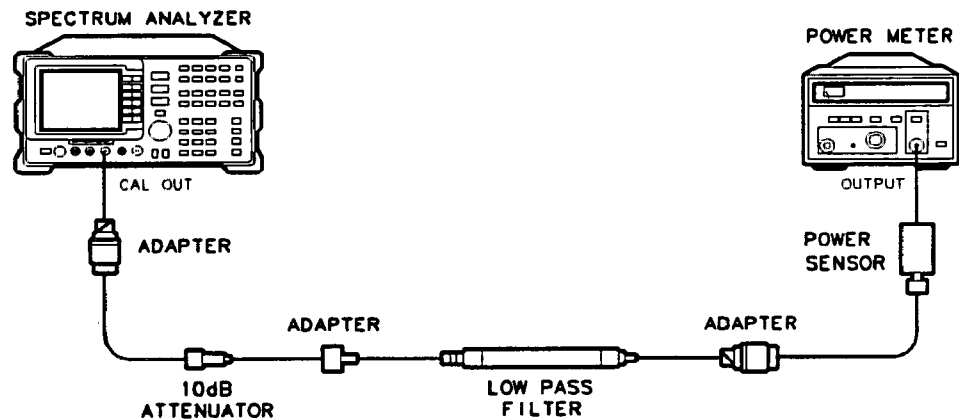

Figure 4-15. Calibrator Amplitude Accuracy Test Setup

- On the HP 436A, press the dBm mode key. Record the HP 436A reading in dBm.

HP 436A Reading \_\_\_\_\_ dBm

- Subtract the Corrected Insertion Loss (step 10) from the HP 436A Reading (step 12) and record as the CAL OUT power. The CAL OUT should be -20 dBm  $\pm$ 0.4 dB.

$$\text{CAL OUT Power} = \text{HP 436A Reading} - \text{Corrected Insertion Loss}$$

### 13. Calibrator Amplitude Accuracy

Example: If the Corrected Insertion Loss is  $-10.0$  dB, and the HP 8902A reading is  $-30$  dB, then  $-30$  dB  $- (-10.0$  dB) =  $-20$  dB

CAL OUT Power \_\_\_\_\_ dBm

---

## 14. Frequency Response

### Specification

Frequency Response

(10 dB input attenuation)

	Preselector	
	Peaked	Unpeaked
<b>Absolute</b>		
9 kHz to 2.9 GHz	N/A	±1.5 dB
2.75 GHz to 6.4 GHz	±2.0 dB	±3.0 dB
6.0 GHz to 12.8 GHz	±2.5 dB	±3.0 dB
12.4 GHz to 19.4 GHz	±3.0 dB	±4.0 dB
19.1 GHz to 22 GHz	±3.0 dB	±4.0 dB
19.1 GHz to 26.5 GHz ( <i>Option 026</i> )	±5.0 dB	±5.0 dB
<b>Relative Flatness</b>		
9 kHz to 2.9 GHz	N/A	±1.0 dB
2.75 GHz to 6.4 GHz	±1.5 dB	N/A
6.0 GHz to 12.8 GHz	±2.0 dB	N/A
12.4 GHz to 19.4 GHz	±2.0 dB	N/A
19.1 GHz to 22 GHz	±2.0 dB	N/A
19.1 GHz to 26.5 GHz ( <i>Option 026</i> )	±2.0 dB	N/A

### Related Adjustment

YTF Adjustment.

Dual Mixer Bias Adjustment.

Frequency Response Adjustment.

### Description

The output of the synthesized sweeper is fed through a power splitter to a power sensor and the HP 8593A. The synthesized sweeper's power level is adjusted at 300 MHz to place the displayed signal at the analyzer's center horizontal graticule line. The measuring receiver, used as a power meter, is placed in **RATIO** mode. At each new sweeper frequency and analyzer center frequency setting, the sweeper's power level is adjusted to place the signal at the center horizontal graticule line. The measuring receiver displays the inverse of the frequency response relative to 300 MHz (**CAL OUT** frequency).

For bands 1 through 4 two measurements are taken, one with the preselector peaked, one with the preselector unpeaked (default).

**Equipment**

Synthesized Sweeper .....	HP 8340A/B
Measuring Receiver (used as a power meter) .....	HP 8902A
Frequency Synthesizer .....	HP 3335A
Power Sensor .....	HP 8485A
Power Splitter .....	HP 11667B
50Ω Termination .....	HP 909D

**Adapters**

Type N (m) to APC 3.5 (m) .....	1250-1743
Type N (f) to BNC (f) .....	1250-1474
3.5 mm (f) to 3.5mm (f) .....	5061-5311

**Cables**

BNC, 122 cm (48 in) .....	HP 10503A
APC 3.5, 91 cm (36 in) .....	8120-4921

**Procedure**

1. Zero and calibrate the HP 8902A and HP 8485A in log mode as described in the *HP 8902A Operation Manual*.
2. Connect the equipment as shown in Figure 4-16. *Option 026*: Connect the output of the power splitter to the analyzer input directly.

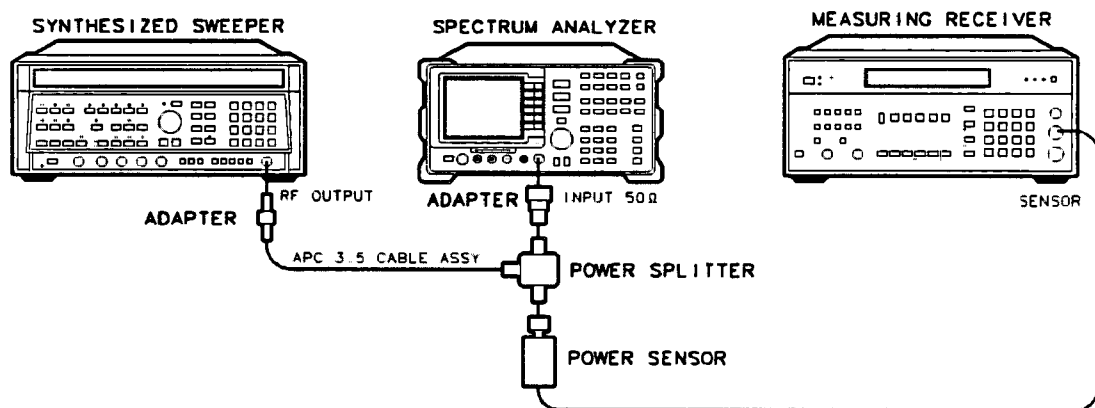

**Figure 4-16. Frequency Response Test Setup,  $\geq 50$  MHz**

3. Press **INSTR PRESET** on the HP 8340A/B. Set the HP 8340A/B controls as follows:
 

CW .....	300 MHz
FREQ STEP .....	100 MHz
POWER LEVEL .....	-8 dBm

#### 14. Frequency Response

4. On the HP 8593A, press **PRESET** and wait for the preset to finish. Press the following analyzer keys:

**SPAN** BAND LOCK 0 - 2.9 Gz BAND 0 .

Set the analyzer's controls as follows:

CENTER FREQUENCY .....	300 MHz
CF STEP .....	100 MHz
SPAN .....	5 MHz
REF LEVEL .....	-10 dBm
LOG dB/DIV .....	1 dB
RES BW .....	1 MHz
VIDEO BW .....	10 kHz

5. On the HP 8593A, press **PEAK SEARCH**, **SIGNAL TRACK** (ON).
6. Adjust the HP 8340A/B power level for a MKR-TRK amplitude reading of -14 dBm  $\pm 0.1$  dB.
7. Press RATIO on the HP 8902A.

#### Frequency Response, Band 0 ( $\geq 50$ MHz)

8. Set the HP 8340A/B CW to 50 MHz.
9. Set the HP 8593A Center Frequency to 50 MHz.
10. Adjust the HP 8340A power level for an HP 8593A MKR-TRK amplitude reading of -14 dBm  $\pm 0.1$  dB.
11. Record the power ratio displayed on the HP 8902A here. Record the negative of the power ratio in Table 4-16.

HP 8902A Reading at 50 MHz \_\_\_\_\_ dB

12. Set the HP 8340A/B CW to 100 MHz.
13. Set the HP 8593A Center Frequency to 100 MHz.
14. Adjust the HP 8340A/B power level for an HP 8593A MKR-TRK amplitude reading of -14 dBm  $\pm 0.1$  dB.
15. Record the negative of the power ratio displayed on the HP 8902A in Table 4-16 as the HP 8902A Reading.
16. On the HP 8340A/B, press **CW**, and **▲** (step up) key and on the HP 8593A, press **FREQUENCY**, **▲** (step up) key to step through the remaining frequencies listed in Table 4-16. At each new frequency repeat steps 13 through 15, entering the power sensor's Cal Factor into the HP 8902A as indicated in Table 4-16.

**Frequency Response, Band 1**

17. Press the following analyzer keys:

**SPAN** BAND LOCK 2.75 - 6.4 BAND 1

Set the controls as follows:

CENTER FREQUENCY ..... 2.75 GHz  
 SPAN ..... 5 MHz  
 RES BW ..... 1 MHz  
 VIDEO BW ..... 10 kHz

Press **PEAK SEARCH**, **SIGNAL TRACK** (ON).

18. Set the HP 8340A/B CW to 2.75 GHz.
19. On the HP 8593A, press **AMPLITUDE**, PRESEL PEAK .
20. Adjust the HP 8340A/B power level for an HP 8593A MKR-TRK amplitude reading of -10 dBm ±0.1 dB.
21. Record the negative of the power ratio displayed on the HP 8902A in Table 4-17, column 2.
22. On the HP 8593A, press **AMPLITUDE**, PRESEL DEFAULT .
23. Adjust the HP 8340A/B power level for an HP 8593A MKR-TRK amplitude reading of -10 dBm ± 0.1 dB.
24. Record the negative of the power ratio displayed on the HP 8902A in Table 4-17, column 3.
25. Set the HP 8340A/B CW and the HP 8593A Center Frequency to 2.8 GHz. Repeat steps 19 through 24.
26. On the HP 8340A/B, press **CW**, and **▲** (step up) key and on the HP 8593A, press **FREQUENCY**, **▲** (step up) key to step through the remaining frequencies listed in Table 4-17. At each new frequency repeat steps 19 through 24, entering the power sensor's Cal Factor into the HP 8902A as indicated in Table 4-17.

**Frequency Response, Band 2**

27. Press the following analyzer keys:

**SPAN** BAND LOCK 6.0 -12.8 BAND 2 .

Set the controls as follows:

CENTER FREQUENCY ..... 6.0 GHz  
 CF STEP ..... 200 MHz  
 SPAN ..... 5 MHz  
 RES BW ..... 1 MHz  
 VIDEO BW ..... 10 kHz

#### 14. Frequency Response

Press **PEAK SEARCH**, **SIGNAL TRACK** (ON).

28. Set the HP 8340A/B CW to 6.0 GHz.
29. On the HP 8593A, press **AMPLITUDE** PRESEL PEAK .
30. Adjust the HP 8340A/B power level for an HP 8593A MKR-TRK amplitude reading of  $-10 \text{ dBm} \pm 0.1 \text{ dB}$ .
31. Record the negative of the power ratio displayed on the HP 8902A in Table 4-18, column 2.
32. On the HP 8593A, press **AMPLITUDE**, PRESEL DEFAULT .
33. Adjust the HP 8340A/B power level for an HP 8593A MKR-TRK amplitude reading of  $-10 \text{ dBm} \pm 0.1 \text{ dB}$ .
34. Record the negative of the power ratio displayed on the HP 8902A in Table 4-18, column 3.
35. On the HP 8340A/B, press **CW**, and **▲** (step up) key and on the HP 8593A, press **FREQUENCY**, and **▲** (step up) key to step through the remaining frequencies listed in Table 4-18.

At each new frequency repeat steps 29 through 34, entering the power sensor's Cal Factor into the HP 8902A as indicated in Table 4-18.

#### Frequency Response, Band 3

36. On the HP 8593A, press the following keys:

**SPAN** BAND LOCK 12.4-19. BAND 3 .

Set the controls as follows:

CENTER FREQUENCY .....	12.4 GHz
SPAN .....	5 MHz
RES BW .....	1 MHz
VIDEO BW .....	10 kHz

Press **PEAK SEARCH**, **SIGNAL TRACK** (ON).

37. Set the HP 8340A/B CW to 12.4 GHz.
38. On the HP 8593A, press **AMPLITUDE**, PRESEL PEAK .
39. Adjust the HP 8340A/B power level for an HP 8593A MKR-TRK amplitude reading of  $-10 \text{ dBm} \pm 0.1 \text{ dB}$ .
40. Record the negative of the power ratio displayed on the HP 8902A in Table 4-19, column 2.
41. On the HP 8593A, press **AMPLITUDE**, PRESEL DEFAULT .
42. Adjust the HP 8340A/B power level for an HP 8593A MKR-TRK amplitude reading of  $-10 \text{ dBm} \pm 0.1 \text{ dB}$ .
43. Record the negative of the power ratio displayed on the HP 8902A in Table 4-19, column 3.



## 14. Frequency Response

44. On the HP 8340A/B, press **CW**, and **▲** (step up) key and on the HP 8593A, press **FREQUENCY**, **▲** (step up) key to step through the remaining frequencies listed in Table 4-19. At each new frequency repeat steps 38 through 43, entering the power sensor's Cal Factor into the HP 8902A as indicated in Table 4-19.

### Frequency Response, Band 4

45. On the HP 8593A, press the following keys:

**SPAN** **BAND LOCK 19.1-22** **BAND 4**.

Set the controls as follows:

CENTER FREQUENCY .....	19.1 GHz
CF STEP .....	100 MHz
CF STEP ( <i>Option 026</i> ) .....	200 MHz
SPAN .....	5 MHz
RES BW .....	1 MHz
VIDEO BW .....	10 kHz

Press **PEAK SEARCH**, **SIGNAL TRACK** (ON).

46. Set the HP 8340A/B CW to 19.1 GHz.
47. On the HP 8593A, press **AMPLITUDE**, **PRESEL PEAK**.
48. Adjust the HP 8340A/B power level for an HP 8593A MKR-TRK amplitude reading of  $-10 \text{ dBm} \pm 0.1 \text{ dB}$ .
49. Record the negative of the power ratio displayed on the HP 8902A in Table 4-20, column 2 (*Option 026*: Table 4-21, column 2.)
50. On the HP 8593A, press **AMPLITUDE**, **PRESEL DEFAULT**.
51. Adjust the HP 8340A/B power level for an HP 8593A MKR-TRK amplitude reading of  $-10 \text{ dBm} \pm 0.1 \text{ dB}$ .
52. Record the negative of the power ratio displayed on the HP 8902A in Table 4-20 column 3. (*Option 026*: Table 4-21 column 3.)
53. On the HP 8340A/B, press **CW**, and **▲** (step up) key and on the HP 8593A, press **FREQUENCY**, **▲** (step up) key to step through the remaining frequencies listed in Table 4-20. At each new frequency repeat steps 47 through 52, entering the power sensor's Cal Factor into the HP 8902A as indicated in Table 4-20, column 2.

### Frequency Response, Band 0 (<50 MHz)

54. On the HP 8593A, press **MKR**, **MARKERS OFF**, **SPAN**, **BAND LOCK**, and **BND LOCK ON OFF** (OFF). Set the controls as follows:

CENTER FREQUENCY .....	50 MHz
SPAN .....	100 kHz
RES BW .....	10 kHz

**14. Frequency Response**

55. Connect the equipment as shown in Figure 4-17, with the power sensor connected to power splitter. *Option 026:* Connect the power splitter to the analyzer input directly.

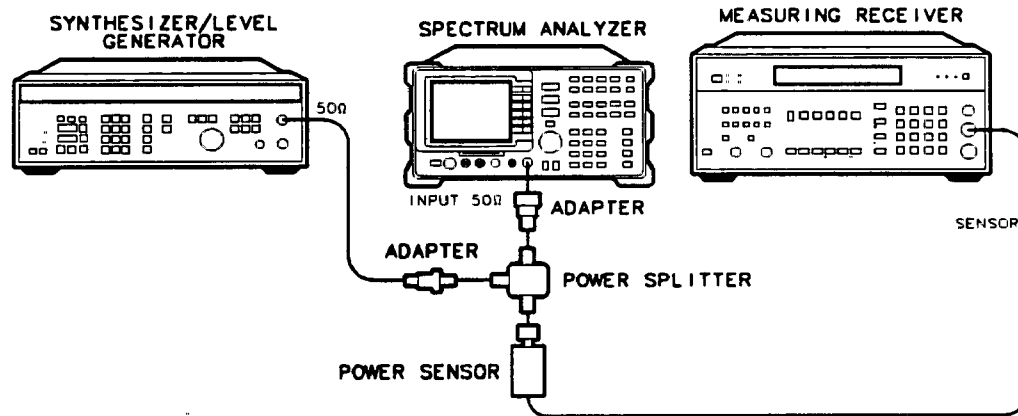

**Figure 4-17. Frequency Response Test Setup (<50 MHz)**

Set the HP 3335A controls as follows:

FREQUENCY ..... 50 MHz  
 AMPLITUDE ..... -8 dBm  
 AMPTD INCR ..... 0.05 dB

56. Enter the power sensor's 50 MHz Cal Factor into the HP 8902A.  
 57. Adjust the HP 3335A amplitude until the HP 8902A display reads the same value as recorded in step 11. Record the HP 3335A amplitude here and in Table 4-22.

HP 3335A Amplitude Setting (50 MHz) \_\_\_\_\_ dBm

58. Replace the HP 8485A Power Sensor with the HP 909D 50Ω termination.  
 59. On the HP 8593A, press **PEAK SEARCH**, **SIGNAL TRACK** (ON), **MARKER DELTA**.  
 60. Set the HP 8593A Center Frequency and the HP 3335A Frequency to the frequencies listed in Table 4-22. At each frequency, adjust the HP 3335A amplitude for a MKR Δ-TRK amplitude reading of 0.00 ±0.05 dB. Record the HP 3335A Amplitude Setting in Table 4-22 as the HP 3335A Amplitude.  
 61. For each of the frequencies in Table 4-22, subtract the HP 3335A Amplitude Reading (column 2) from the HP 3335A Amplitude Setting (50 MHz) recorded in step 57. Record the result as the Response Relative to 50 MHz (column 3) of Table 4-22.  
 62. Add to each of the Response Relative to 50 MHz entries in Table 4-22 the HP 8902A Reading for 50 MHz listed in Table 4-16. Record the results as the Response Relative to 300 MHz (column 4) in Table 4-22.

Test Results

63. Frequency Response, Band 0

- a. Enter most positive number from Table 4-22, column 4: \_\_\_\_\_ dB
- b. Enter most positive number from Table 4-16, column 2: \_\_\_\_\_ dB
- c. Enter more positive of numbers from (a) and (b): \_\_\_\_\_ dB  
(absolute referenced to 300 MHz).
- d. Enter most negative number from Table 4-22, column 4: \_\_\_\_\_ dB
- e. Enter most negative number from Table 4-16, column 2: \_\_\_\_\_ dB
- f. Enter more negative of numbers from (d) and (e): \_\_\_\_\_ dB
- g. Subtract (f) from (c): \_\_\_\_\_ dB  
(relative flatness).

The result should be less than 2.0 dB.

h. The absolute values in (c) and (f) should be less than 1.0 dB.

64. Frequency Response, Band 1 (Preselector Peaked)

- a. Enter most positive number from Table 4-17, column 2: \_\_\_\_\_ dB  
The absolute value of this number should be less than 2.0 dB.
- b. Enter most negative number from Table 4-17, column 2: \_\_\_\_\_ dB  
The absolute value of this number should be less than 2.0 dB.
- c. Subtract (b) from (a): \_\_\_\_\_ dB  
The result should be less than 3.0 dB (relative flatness).

65. Frequency Response, Band 1 (Preselector Unpeaked)

- a. Enter most positive number from Table 4-17, column 3: \_\_\_\_\_ dB  
The absolute value of this number should be less than 3.0 dB.
- b. Enter most negative number from Table 4-17, column 3: \_\_\_\_\_ dB  
The absolute value of this number should be less than 3.0 dB.

66. Frequency Response, Band 2 (Preselector Peaked)

- a. Enter most positive number from Table 4-18, column 2: \_\_\_\_\_ dB  
The absolute value of this number should be less than 2.5 dB.
- b. Enter most negative number from Table 4-18, column 2: \_\_\_\_\_ dB  
The absolute value of this number should be less than 2.5 dB.
- c. Subtract (b) from (a): \_\_\_\_\_ dB  
The result should be less than 4.0 dB (relative flatness).

67. Frequency Response, Band 2 (Preselector Unpeaked)

- a. Enter most positive number from Table 4-18, column 3: \_\_\_\_\_ dB  
The absolute value of this number should be less than 3.0 dB.
- b. Enter most negative number from Table 4-18, column 3: \_\_\_\_\_ dB  
The absolute value of this number should be less than 3.0 dB.

## 14. Frequency Response

### 68. Frequency Response, Band 3 (Preselector Peaked)

- a. Enter most positive number from Table 4-19, column 2: \_\_\_\_\_ dB  
The absolute value of this number should be less than 3.0 dB.
- b. Enter most negative number from Table 4-19, column 2: \_\_\_\_\_ dB  
The absolute value of this number should be less than 3.0 dB.
- c. Subtract (b) from (a): \_\_\_\_\_ dB  
The result should be less than 4.0 dB (relative flatness).

### 69. Frequency Response, Band 3 (Preselector Unpeaked)

- a. Enter most positive number from Table 4-19, column 3: \_\_\_\_\_ dB  
The absolute value of this number should be less than 4.0 dB.
- b. Enter most negative number from Table 4-19, column 3: \_\_\_\_\_ dB  
The absolute value of this number should be less than 4.0 dB.

### 70. Frequency Response, Band 4 (Preselector Peaked)

*(Proceed to step 72 if spectrum analyzer has Option 026 installed.)*

- a. Enter most positive number from Table 4-20, column 2: \_\_\_\_\_ dB  
The absolute value of this number should be less than 3.0 dB.
- b. Enter most negative number from Table 4-20, column 2: \_\_\_\_\_ dB  
The absolute value of this number should be less than 3.0 dB.
- c. Subtract (b) from (a): \_\_\_\_\_ dB  
The result should be less than 4.0 dB (relative flatness).

### 71. Frequency Response, Band 4 (Preselector Unpeaked)

- a. Enter most positive number from Table 4-20, column 3: \_\_\_\_\_ dB  
The absolute value of this number should be less than 4.0 dB.
- b. Enter most negative number from Table 4-20, column 3: \_\_\_\_\_ dB  
The absolute value of this number should be less than 4.0 dB.

### 72. Frequency Response, Band 4 (Preselector Peaked), Option 026

- a. Enter most positive number from Table 4-21, column 2: \_\_\_\_\_ dB  
The absolute value of this number should be less than 5.0 dB.
- b. Enter most negative number from Table 4-21, column 2: \_\_\_\_\_ dB  
The absolute value of this number should be less than 5.0 dB.
- c. Subtract (b) from (a): \_\_\_\_\_ dB  
The result should be less than 4.0 dB (relative flatness).

### 73. Frequency Response, Band 4 (Preselector Unpeaked), Option 026

- a. Enter most positive number from Table 4-21, column 3: \_\_\_\_\_ dB  
The absolute value of this number should be less than 5.0 dB.
- b. Enter most negative number from Table 4-21, column 3: \_\_\_\_\_ dB  
The absolute value of this number should be less than 5.0 dB.

14. Frequency Response

Table 4-16. Frequency Response Band 0 ( $\geq 50$  MHz)

Column 1 Frequency (MHz)	Column 2 HP 8902A Reading (dB)	Column 3 CAL FACTOR Frequency (GHz)	Column 4 Measurement Uncertainty
50	_____	0.05	+0.29/-0.31 dB
100	_____	0.05	+0.29/-0.31 dB
200	_____	0.05	+0.29/-0.31 dB
300	_____	0.05	0 (Reference)
400	_____	0.05	+0.29/-0.31 dB
500	_____	0.05	+0.29/-0.31 dB
600	_____	0.05	+0.29/-0.31 dB
700	_____	0.05	+0.29/-0.31 dB
800	_____	0.05	+0.29/-0.31 dB
900	_____	0.05	+0.29/-0.31 dB
1000	_____	0.05	+0.29/-0.31 dB
1100	_____	2.0	+0.29/-0.31 dB
1200	_____	2.0	+0.29/-0.31 dB
1300	_____	2.0	+0.29/-0.31 dB
1400	_____	2.0	+0.29/-0.31 dB
1500	_____	2.0	+0.29/-0.31 dB
1600	_____	2.0	+0.29/-0.31 dB
1700	_____	2.0	+0.29/-0.31 dB
1800	_____	2.0	+0.29/-0.31 dB
1900	_____	2.0	+0.29/-0.31 dB
2000	_____	2.0	+0.29/-0.31 dB
2100	_____	2.0	+0.29/-0.31 dB
2200	_____	2.0	+0.29/-0.31 dB
2300	_____	2.0	+0.29/-0.31 dB
2400	_____	2.0	+0.29/-0.31 dB
2500	_____	3.0	+0.29/-0.31 dB
2600	_____	3.0	+0.29/-0.31 dB
2700	_____	3.0	+0.29/-0.31 dB
2800	_____	3.0	+0.29/-0.31 dB
2900	_____	3.0	+0.29/-0.31 dB

## 14. Frequency Response

**Table 4-17. Frequency Response Band 1**

Column 1 Frequency (GHz)	Column 2 HP 8902A Preselector Peaked Reading (dB)	Column 3 HP 8902A Preselector Unpeaked Reading (dB)	Column 4 CAL FACTOR Frequency (GHz)	Column 5 Measurement Uncertainty
2.75	_____	_____	3.0	+0.43/-0.47 dB
2.8	_____	_____	3.0	+0.43/-0.47 dB
2.9	_____	_____	3.0	+0.43/-0.47 dB
3.0	_____	_____	3.0	+0.43/-0.47 dB
3.1	_____	_____	3.0	+0.43/-0.47 dB
3.2	_____	_____	3.0	+0.43/-0.47 dB
3.3	_____	_____	3.0	+0.43/-0.47 dB
3.4	_____	_____	3.0	+0.43/-0.47 dB
3.5	_____	_____	4.0	+0.43/-0.47 dB
3.6	_____	_____	4.0	+0.43/-0.47 dB
3.7	_____	_____	4.0	+0.43/-0.47 dB
3.8	_____	_____	4.0	+0.43/-0.47 dB
3.9	_____	_____	4.0	+0.43/-0.47 dB
4.0	_____	_____	4.0	+0.43/-0.47 dB
4.1	_____	_____	4.0	+0.43/-0.47 dB
4.2	_____	_____	4.0	+0.43/-0.47 dB
4.3	_____	_____	4.0	+0.43/-0.47 dB
4.4	_____	_____	4.0	+0.43/-0.47 dB
4.5	_____	_____	5.0	+0.43/-0.47 dB
4.6	_____	_____	5.0	+0.43/-0.47 dB
4.7	_____	_____	5.0	+0.43/-0.47 dB
4.8	_____	_____	5.0	+0.43/-0.47 dB
4.9	_____	_____	5.0	+0.43/-0.47 dB
5.0	_____	_____	5.0	+0.43/-0.47 dB
5.1	_____	_____	5.0	+0.43/-0.47 dB
5.2	_____	_____	5.0	+0.43/-0.47 dB

14. Frequency Response

Table 4-17. Frequency Response Band 1 (continued)

Column 1 Frequency (GHz)	Column 2 HP 8902A Reading (dB) Preselector Peaked	Column 3 HP 8902A Reading (dB) Preselector Unpeaked	Column 4 CAL FACTOR Frequency (GHz)	Column 5 Measurement Uncertainty
5.3	_____	_____	5.0	+0.43/-0.47 dB
5.4	_____	_____	5.0	+0.43/-0.47 dB
5.5	_____	_____	6.0	+0.43/-0.47 dB
5.6	_____	_____	6.0	+0.43/-0.47 dB
5.7	_____	_____	6.0	+0.43/-0.47 dB
5.8	_____	_____	6.0	+0.43/-0.47 dB
5.9	_____	_____	6.0	+0.43/-0.47 dB
6.0	_____	_____	6.0	+0.43/-0.47 dB
6.1	_____	_____	6.0	+0.43/-0.47 dB
6.2	_____	_____	6.0	+0.43/-0.47 dB
6.3	_____	_____	6.0	+0.43/-0.47 dB
6.4	_____	_____	6.0	+0.43/-0.47 dB

14. Frequency Response

Table 4-18. Frequency Response Band 2

Column 1 Frequency (GHz)	Column 2 HP 8902A Reading (dB) Preselector Peaked	Column 3 HP 8902A Reading (dB) Preselector Unpeaked	Column 4 CAL FACTOR Frequency (GHz)	Column 5 Measurement Uncertainty
6.0	_____	_____	6.0	+0.43/-0.48 dB
6.2	_____	_____	6.0	+0.43/-0.48 dB
6.4	_____	_____	6.0	+0.43/-0.48 dB
6.6	_____	_____	7.0	+0.43/-0.48 dB
6.8	_____	_____	7.0	+0.43/-0.48 dB
7.0	_____	_____	7.0	+0.43/-0.48 dB
7.2	_____	_____	7.0	+0.43/-0.48 dB
7.4	_____	_____	7.0	+0.43/-0.48 dB
7.6	_____	_____	8.0	+0.43/-0.48 dB
7.8	_____	_____	8.0	+0.43/-0.48 dB
8.0	_____	_____	8.0	+0.43/-0.48 dB
8.2	_____	_____	8.0	+0.43/-0.48 dB
8.4	_____	_____	8.0	+0.43/-0.48 dB
8.6	_____	_____	9.0	+0.43/-0.48 dB
8.8	_____	_____	9.0	+0.43/-0.48 dB
9.0	_____	_____	9.0	+0.43/-0.48 dB
9.2	_____	_____	9.0	+0.43/-0.48 dB
9.4	_____	_____	9.0	+0.43/-0.48 dB
9.6	_____	_____	10.0	+0.43/-0.48 dB
9.8	_____	_____	10.0	+0.43/-0.48 dB
10.0	_____	_____	10.0	+0.43/-0.48 dB
10.2	_____	_____	10.0	+0.43/-0.48 dB
10.4	_____	_____	10.0	+0.43/-0.48 dB
10.6	_____	_____	11.0	+0.43/-0.48 dB
10.8	_____	_____	11.0	+0.43/-0.48 dB
11.0	_____	_____	11.0	+0.43/-0.48 dB
11.2	_____	_____	11.0	+0.43/-0.48 dB
11.4	_____	_____	11.0	+0.43/-0.48 dB



14. Frequency Response

Table 4-18. Frequency Response Band 2 (continued)

Column 1 Frequency (GHz)	Column 2 HP 8902A Reading (dB) Preselector Peaked	Column 3 HP 8902A Reading (dB) Preselector Unpeaked	Column 4 CAL FACTOR Frequency (GHz)	Column 5 Measurement Uncertainty
11.6	_____	_____	12.0	+0.43/-0.48 dB
11.8	_____	_____	12.0	+0.43/-0.48 dB
12.0	_____	_____	12.0	+0.43/-0.48 dB
12.2	_____	_____	12.0	+0.43/-0.48 dB
12.4	_____	_____	12.0	+0.43/-0.48 dB
12.6	_____	_____	13.0	+0.43/-0.48 dB
12.8	_____	_____	13.0	+0.43/-0.48 dB

## 14. Frequency Response

**Table 4-19. Frequency Response Band 3**

Column 1 Frequency (GHz)	Column 2 HP 8902A Reading (dB) Preselector Peaked	Column 3 HP 8902A Reading (dB) Preselector Unpeaked	Column 4 CAL FACTOR Frequency (GHz)	Column 5 Measurement Uncertainty
12.4	_____	_____	12.0	+0.43/-0.48 dB
12.6	_____	_____	13.0	+0.43/-0.48 dB
12.8	_____	_____	13.0	+0.43/-0.48 dB
13.0	_____	_____	13.0	+0.43/-0.48 dB
13.2	_____	_____	13.0	+0.43/-0.48 dB
13.4	_____	_____	13.0	+0.43/-0.48 dB
13.6	_____	_____	14.0	+0.43/-0.48 dB
13.8	_____	_____	14.0	+0.43/-0.48 dB
14.0	_____	_____	14.0	+0.43/-0.48 dB
14.2	_____	_____	14.0	+0.43/-0.48 dB
14.4	_____	_____	14.0	+0.43/-0.48 dB
14.6	_____	_____	15.0	+0.43/-0.48 dB
14.8	_____	_____	15.0	+0.43/-0.48 dB
15.0	_____	_____	15.0	+0.43/-0.48 dB
15.2	_____	_____	15.0	+0.43/-0.48 dB
15.4	_____	_____	15.0	+0.43/-0.48 dB
15.6	_____	_____	16.0	+0.43/-0.48 dB
15.8	_____	_____	16.0	+0.43/-0.48 dB
16.0	_____	_____	16.0	+0.43/-0.48 dB
16.2	_____	_____	16.0	+0.43/-0.48 dB
16.4	_____	_____	16.0	+0.43/-0.48 dB
16.6	_____	_____	17.0	+0.43/-0.48 dB
16.8	_____	_____	17.0	+0.43/-0.48 dB
17.0	_____	_____	17.0	+0.43/-0.48 dB
17.2	_____	_____	17.0	+0.43/-0.48 dB

14. Frequency Response

Table 4-19. Frequency Response Band 3 (continued)

Column 1 Frequency (GHz)	Column 2 HP 8902A Reading (dB) Preselector Peaked	Column 3 HP 8902A Reading (dB) Preselector Unpeaked	Column 4 CAL FACTOR Frequency (GHz)	Column 5 Measurement Uncertainty
17.4	_____	_____	17.0	+0.43/-0.48 dB
17.6	_____	_____	18.0	+0.43/-0.48 dB
17.8	_____	_____	18.0	+0.43/-0.48 dB
18.0	_____	_____	18.0	+0.43/-0.48 dB
18.2	_____	_____	18.0	+0.43/-0.48 dB
18.4	_____	_____	18.0	+0.43/-0.48 dB
18.6	_____	_____	19.0	+0.43/-0.48 dB
18.8	_____	_____	19.0	+0.43/-0.48 dB
19.0	_____	_____	19.0	+0.43/-0.48 dB
19.2	_____	_____	19.0	+0.43/-0.48 dB
19.4	_____	_____	19.0	+0.43/-0.48 dB

14. Frequency Response

Table 4-20. Frequency Response Band 4

Column 1 Frequency GHz	Column 2 HP 8902A Reading (dB) Preselector Peaked	Column 3 HP 8902A Reading (dB) Preselector Unpeaked	Column 4 CAL FACTOR Frequency (GHz)	Column 5 Measurement Uncertainty
19.1	_____	_____	19.0	+0.55/-0.59 dB
19.2	_____	_____	19.0	+0.55/-0.59 dB
19.3	_____	_____	19.0	+0.55/-0.59 dB
19.4	_____	_____	19.0	+0.55/-0.59 dB
19.5	_____	_____	20.0	+0.55/-0.59 dB
19.6	_____	_____	20.0	+0.55/-0.59 dB
19.7	_____	_____	20.0	+0.55/-0.59 dB
19.8	_____	_____	20.0	+0.55/-0.59 dB
19.9	_____	_____	20.0	+0.55/-0.59 dB
20.0	_____	_____	20.0	+0.55/-0.59 dB
20.1	_____	_____	20.0	+0.55/-0.59 dB
20.2	_____	_____	20.0	+0.55/-0.59 dB
20.3	_____	_____	20.0	+0.55/-0.59 dB
20.4	_____	_____	20.0	+0.55/-0.59 dB
20.5	_____	_____	21.0	+0.55/-0.59 dB
20.6	_____	_____	21.0	+0.55/-0.59 dB
20.7	_____	_____	21.0	+0.55/-0.59 dB
20.8	_____	_____	21.0	+0.55/-0.59 dB
20.9	_____	_____	21.0	+0.55/-0.59 dB
21.0	_____	_____	21.0	+0.55/-0.59 dB
21.1	_____	_____	21.0	+0.55/-0.59 dB
21.2	_____	_____	21.0	+0.55/-0.59 dB
21.3	_____	_____	21.0	+0.55/-0.59 dB
21.4	_____	_____	21.0	+0.55/-0.59 dB
21.5	_____	_____	22.0	+0.55/-0.59 dB
21.6	_____	_____	22.0	+0.55/-0.59 dB

14. Frequency Response

Table 4-20. Frequency Response Band 4 (continued)

Column 1 Frequency GHz	Column 2 HP 8902A Reading (dB) Preselector Peaked	Column 3 HP 8902A Reading (dB) Preselector Unpeaked	Column 4 CAL FACTOR Frequency (GHz)	Column 5 Measurement Uncertainty
21.7	_____	_____	22.0	+0.55/-0.59 dB
21.8	_____	_____	22.0	+0.55/-0.59 dB
21.9	_____	_____	22.0	+0.55/-0.59 dB
22.0	_____	_____	22.0	+0.55/-0.59 dB

14. Frequency Response

Table 4-21. Frequency Response Band 4, Option 026

Column 1 Frequency (GHz)	Column 2 HP 8902A Reading (dB) Preselector Peaked	Column 3 HP 8902A Reading (dB) Preselector Unpeaked	Column 4 CAL FACTOR Frequency (GHz)	Column 5 Measurement Uncertainty
19.1	_____	_____	19.0	+0.55/-0.59 dB
19.3	_____	_____	19.0	+0.55/-0.59 dB
19.5	_____	_____	20.0	+0.55/-0.59 dB
19.7	_____	_____	20.0	+0.55/-0.59 dB
19.9	_____	_____	20.0	+0.55/-0.59 dB
20.1	_____	_____	20.0	+0.55/-0.59 dB
20.3	_____	_____	20.0	+0.55/-0.59 dB
20.5	_____	_____	21.0	+0.55/-0.59 dB
20.7	_____	_____	21.0	+0.55/-0.59 dB
20.9	_____	_____	21.0	+0.55/-0.59 dB
21.1	_____	_____	21.0	+0.55/-0.59 dB
21.3	_____	_____	21.0	+0.55/-0.59 dB
21.5	_____	_____	22.0	+0.55/-0.59 dB
21.7	_____	_____	22.0	+0.55/-0.59 dB
21.9	_____	_____	22.0	+0.55/-0.59 dB
22.1	_____	_____	22.0	+0.55/-0.59 dB
22.3	_____	_____	22.0	+0.55/-0.59 dB
22.5	_____	_____	23.0	+0.55/-0.59 dB
22.7	_____	_____	23.0	+0.55/-0.59 dB
22.9	_____	_____	23.0	+0.55/-0.59 dB
23.1	_____	_____	23.0	+0.55/-0.59 dB
23.3	_____	_____	23.0	+0.55/-0.59 dB
23.5	_____	_____	24.0	+0.55/-0.59 dB
23.7	_____	_____	24.0	+0.55/-0.59 dB
23.9	_____	_____	24.0	+0.55/-0.59 dB
24.1	_____	_____	24.0	+0.55/-0.59 dB
24.3	_____	_____	24.0	+0.55/-0.59 dB
24.5	_____	_____	25.0	+0.55/-0.59 dB
24.7	_____	_____	25.0	+0.55/-0.59 dB

14. Frequency Response

Table 4-21. Frequency Response Band 4, Option 026 (continued)

Column 1 Frequency (GHz)	Column 2 HP 8902A Reading (dB) Preselector Peaked	Column 3 HP 8902A Reading (dB) Preselector Unpeaked	Column 4 CAL FACTOR Frequency (GHz)	Column 5 Measurement Uncertainty
24.9	_____	_____	25.0	+0.55/-0.59 dB
25.1	_____	_____	25.0	+0.55/-0.59 dB
25.3	_____	_____	25.5	+0.55/-0.59 dB
25.5	_____	_____	25.5	+0.55/-0.59 dB
25.7	_____	_____	25.5	+0.55/-0.59 dB
25.9	_____	_____	26.0	+0.55/-0.59 dB
26.1	_____	_____	26.0	+0.55/-0.59 dB
26.3	_____	_____	26.5	+0.55/-0.59 dB
26.5	_____	_____	26.5	+0.55/-0.59 dB

Table 4-22. Frequency Response Band 0 (<50 MHz)

Column 1 HP 8593A HP 3335A Frequency	Column 2 HP 3335A Amplitude (dBm)	Column 3 Response Relative to 50 MHz	Column 4 Response Relative to 300 MHz	Column 5 Measurement Uncertainty
50 MHz	_____	0 (Reference)	_____	+0.34/-0.37
20 MHz	_____	_____	_____	+0.34/-0.37
10 MHz	_____	_____	_____	+0.34/-0.37
5 MHz	_____	_____	_____	+0.34/-0.37
1 MHz	_____	_____	_____	+0.34/-0.37
200 kHz	_____	_____	_____	+0.34/-0.37
50 kHz	_____	_____	_____	+0.34/-0.37

---

## 15. Other Input Related Spurious

### Specification

- <-70 dBc for applied frequencies  $\leq 18$  GHz.
- <-60 dBc for applied frequencies  $\leq 22$  GHz.

### Description

A synthesized source and the spectrum analyzer are set to the same frequency and the amplitude of the source is set to 0 dBm. A marker amplitude reference is set on the analyzer. The source is then tuned to several different frequencies which should generate image, multiple, and out-of-band responses. At each source frequency, the source amplitude is set to 0 dBm and the amplitude of the response, if any, is measured using the analyzer's marker function. The marker amplitude difference is then compared to the specification.

### Equipment

Synthesized Sweeper .....	HP 8340A/B
Measuring Receiver (or Power Meter) .....	HP 8902A
Power Sensor .....	HP 8485A
Power Splitter .....	HP 11667B

### Adapters

Type N (m) to APC 3.5 (m) .....	1250-1743
APC 3.5 (f) to APC 3.5 (f) .....	5061-5311

### Cable

APC 3.5 male connectors, 91 cm (36 in) .....	8120-4921
--	-----------

### Procedure

#### Band 0

1. Zero and calibrate the HP 8902A and HP 8485A in log mode (power reads out in dBm). Enter the power sensor's 2 GHz Cal Factor into the HP 8902A.
2. Press **INSTR PRESET** on the HP 8340A/B and set the controls as follows:

CW .....	2000 MHz
POWER LEVEL .....	-4 dBm
3. Connect the equipment as shown in Figure 4-18. *Option 026:* Connect the power splitter to the analyzer input directly.



## 15. Other Input Related Spurious

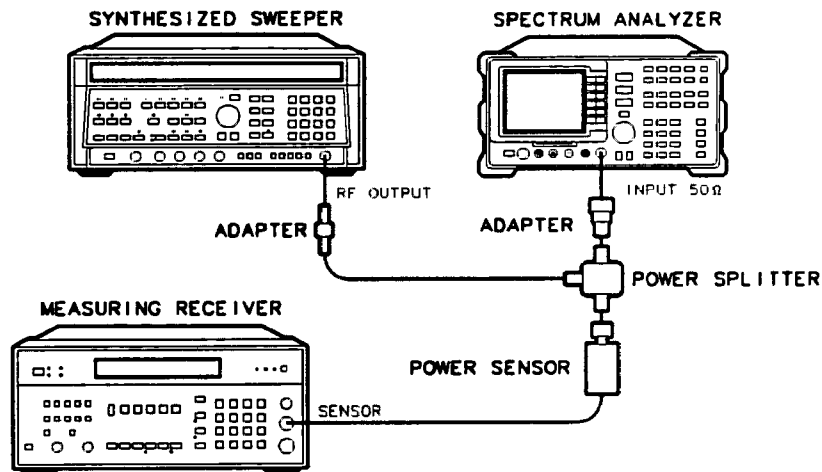

Figure 4-18. Other Input Related Spurious Test Setup

4. On the HP 8593A, press **PRESET** and wait for the preset to finish. Set the controls as follows:

CENTER FREQUENCY ..... 2.0 GHz  
 SPAN ..... 1 MHz  
 REF LEVEL ..... -10 dBm  
 ATTEN ..... 0 dB

5. Adjust the HP 8340A/B power level for a  $-10 \text{ dBm} \pm 0.1 \text{ dB}$  reading on the HP 8902A.  
 6. On the HP 8593A, press the following keys:

**PEAK SEARCH**  
**SIGNAL TRACK** (ON)  
**SPAN** 200 **kHz**.

Wait for the AUTO ZOOM message to disappear. Press the following analyzer keys:

**PEAK SEARCH** **MKR ->** **MARKER ->** **REF LVL**  
**SIGNAL TRACK** (OFF) **PEAK SEARCH** **MARKER DELTA** **AMPLITUDE** **▼** (step-down key)  
**SGL SWP**.

7. For each of the frequencies listed in Table 4-23 for Band 0, do the following:
- Set the HP 8340A/B to the listed CW frequency.
  - Enter the appropriate power sensor Cal Factor into the HP 8902A.
  - Set the HP 8340A/B power level for a  $-10 \text{ dBm}$  reading on the HP 8902A.
  - Press **SGL SWP** and wait for completion of a new sweep.
  - On the HP 8593A, press **PEAK SEARCH** and record the MKR  $\Delta$  amplitude reading in Table 4-23 as the Actual MKR  $\Delta$  Amplitude.

The Actual MKR  $\Delta$  Amplitude should be less than the Max MKR  $\Delta$  Amplitude listed in the table.

## 15. Other Input Related Spurious

### Note



The Max MKR  $\Delta$  Amplitude is 10 dB more positive than the specification. This is due to the 10 dB change in reference level made in step 6.

8. On the HP 8593A, press **MKR** and **MARKERS OFF**, **HOLD**, **AUTO COUPLE** AUTO ALL .

Set the controls as follows:

SPAN	.....	1 MHz
REF LEVEL	.....	-10 dBm
ATTEN	.....	0 dB
SWEEP	.....	CONT

### Band 1

9. Set the HP 8593A Center Frequency to 4 GHz.  
10. Set the HP 8340A/B CW to 4 GHz.  
11. Enter the power sensor's 4 GHz Cal Factor into the HP 8902A.  
12. On the HP 8593A, press the following keys:

**PEAK SEARCH** **AMPLITUDE** **PRESEL PEAK** .

Wait for the **CAL: PEAKING** message to disappear. Press **MKR**, **MARKERS OFF** .

13. Repeat steps 5 through 8 for the HP 8340A/B CW frequencies listed in Table 4-23 for Band 1.

### Band 2

14. Set the HP 8593A Center Frequency to 9 GHz.  
15. Set the HP 8340A/B CW to 9 GHz.  
16. Enter the power sensor's 9 GHz Cal Factor into the HP 8902A.  
17. On the HP 8593A, press **PEAK SEARCH**, **AMPLITUDE**, **PRESEL PEAK** .

Wait for the **CAL: PEAKING** message to disappear. Press **MKR**, **MARKERS OFF** .

18. Repeat steps 5 through 8 for the HP 8340A/B CW frequencies listed in Table 4-23 for Band 2.

### Band 3

19. Set the HP 8593A Center Frequency to 15 GHz.  
20. Set the HP 8340A/B CW to 15 GHz.  
21. Enter the power sensor's 15 GHz Cal Factor into the HP 8902A.

## 15. Other Input Related Spurious

22. On the HP 8593A, press **PEAK SEARCH**, **AMPLITUDE**, PRESEL PEAK . Wait for the CAL: PEAKING message to disappear. Press **MKR**, MARKERS OFF .
23. Repeat steps 5 through 8 for the HP 8340A/B CW frequencies listed in Table 4-23 for Band 3.

### Band 4

24. Set the HP 8593A Center Frequency to 21 GHz.
25. Set the HP 8340A/B CW to 21 GHz.
26. Enter the power sensor's 21 GHz Cal Factor into the HP 8902A.
27. On the HP 8593A, press **PEAK SEARCH**, **AMPLITUDE**, PRESEL PEAK .  
Wait for the CAL: PEAKING message to disappear. Press **MKR**, MARKERS OFF .
28. Repeat steps 5 through 8 for the HP 8340A/B CW frequencies listed in Table 4-23 for Band 4.

### Band 4, Option 026 Only

29. Set the HP 8593A Center Frequency to 24 GHz.
30. Set the HP 8340A/B CW to 24 GHz.
31. Enter the power sensor's 24 GHz Cal Factor into the HP 8902A.
32. On the HP 8593A, press **PEAK SEARCH**, **AMPLITUDE**, PRESEL PEAK .  
Wait for the CAL: PEAKING message to disappear. Press **MKR**, MARKERS OFF .
33. Repeat steps 5 through 8 for the HP 8340A/B CW frequencies listed in Table 4-23 for band 4, Option 026.

### Specification Summary

34. Record the maximum Actual MKR  $\Delta$  Amplitude from Table 4-23 for Band 0.

Maximum Response Amplitude  
50 kHz to 2.9 GHz \_\_\_\_\_ dBc

35. Record the maximum Actual MKR  $\Delta$  Amplitude from Table 4-23 for Bands 1, 2 and 3.

Maximum Response Amplitude, 2.75 to 22 GHz,  
Applied Frequency  $\leq$  18 GHz \_\_\_\_\_ dBc

**15. Other Input Related Spurious**

36. Record the maximum Actual MKR  $\Delta$  Amplitude from Table 4-23 for Band 4.

Maximum Response Amplitude, 2.75 to 22 GHz,  
Applied Frequency  $\leq$  22 GHz \_\_\_\_\_ dBc

37. *For Option 026 only:* Record the maximum Actual MKR  $\Delta$  Amplitude from Table 4-23  
band 4, Option 026.

Maximum Response Amplitude, 2.75 GHz to 26.5 GHz,  
Applied Frequency  $\leq$  22 GHz \_\_\_\_\_ dBc.

15. Other Input Related Spurious

Table 4-23. Other Input Related Spurious

Band	HP 8593A	HP 8340A/B	MKR $\Delta$ Amplitude	
	Center Frequency	CW Frequency	Actual (dBc)	Max (dBc)
	GHz	MHz		
0	2.0	2042.8 (1)	_____	-70
	2.0	2642.8 (1)	_____	-70
	2.0	9821.4 (2)	_____	-70
	2.0	7331.9 (2)	_____	-70
	2.0	1820.8 (3)	_____	-70
	2.0	278.5 (3)	_____	-70
1	4.0	4042.8 (1)	_____	-70
	4.0	4642.8 (1)	_____	-70
	4.0	8963.9 (2)	_____	-70
	4.0	3742.9 (3)	_____	-70
2	9.0	9042.8 (1)	_____	-70
	9.0	9642.8 (1)	_____	-70
	9.0	4682.05 (2)	_____	-70
	9.0	9942.5 (3)	_____	-70
3	15.0	15042.8 (1)	_____	-70
	15.0	15642.8 (1)	_____	-70
	15.0	4785.8 (2)	_____	-70
	15.0	14700.1 (3)	_____	-70
4	21.0	21042.8 (1)	_____	-60
	21.0	21642.8 (1)	_____	-60
	21.0	5009.025 (2)	_____	-70
	21.0	20007.1 (3)	_____	-60
4, Option 26	24	24042.8 (1)	_____	-60
	24	24642.8 (1)	_____	-60
	24	10682.1 (2)	_____	-70
	24	20019.65 (3)	_____	-60
(1) Image Response				
(2) Out-of-Band Response				
(3) Multiple Response				

---

## 16. Spurious Response

### Specification

#### Second Harmonic Distortion:

10 MHz to 2.9 GHz	< -70 dBc for -40 dBm tone at mixer power.
>2.75 GHz	< -100 dBc for -10 dBm tone at mixer power. (or below average noise level)

#### Third Order Intermodulation Distortion:

>10 MHz	< -70 dBc for two -30 dBm tones at mixer power and 50 kHz spacing.
---------	--

### Description

This test is performed in two parts. The first part measures second harmonic distortion; the second part measures third order intermodulation distortion. Second harmonic distortion and third order intermodulation distortion is checked in both low band (50 kHz to 2.9 GHz) and high band (2.75 to 22 GHz).

To test second harmonic distortion, 50 MHz and 4.4 GHz low pass filters are used to filter the source output, ensuring that harmonics read by the analyzer are internally generated and not coming from the source. The distortion products are measured using the analyzer's marker functions.

For third order intermodulation distortion, two signals are combined in a directional coupler (for isolation) and are applied to the analyzer input. The power level of the two signals is 8 dB higher than specified, so the distortion products should be suppressed by 16 dB less than specified. In this manner, the equivalent Third Order Intercept (TOI) is measured.

With two -30 dBm signals at the input mixer and the distortion products suppressed by 70 dBc, the equivalent TOI is +5 dBm (-30 dBm + 70 dBc/2). However, if two -22 dBm signals are present at the input mixer and the distortion products are suppressed by 54 dBc, the equivalent TOI is also +5 dBm (-22 dBm + 54 dBc/2).

Performing the test with a higher power level maintains the measurement integrity while reducing both test time and the dependency upon the source's noise sideband performance.

### Equipment

Synthesized Sweeper (2 required)	HP 8340A/B
Measuring Receiver (or Power Meter)	HP 8902A
Power Sensor, 50 MHz to 26.5 GHz	HP 8485A
Power Splitter	HP 11667B
50 MHz Low Pass Filter	0955-0306
4.4 GHz Low Pass Filter (2 required)	HP 11689A
Directional Coupler	0955-0125

### Cables

APC 3.5 Cable 91 cm (36 in)	8120-4921
-----------------------------	-----------

BNC Cable 120 cm (48 in) ..... HP 10503A

**Adapters**

Type N (m) to APC 3.5 (m) ..... 1250-1743  
 APC 3.5 (f) to APC 3.5 (f)(2 required) ..... 5061-5311  
 Type N (f) to APC 3.5 (f) ..... 1250-1745  
 Type N (m) to BNC (f) (2 required) ..... 1250-1476  
 Type N (m) to APC 3.5 (f) ..... 1250-1744  
 Type N (f) to BNC (m) ..... 1250-1477

**Additional Equipment for Option 026**

Adapter, APC 3.5 (f) to Type N (m) ..... 1250-1745

**Procedure**

**Second Harmonic Distortion, <2.9 GHz**

1. Press **PRESET** on the HP 8340A/B and set the controls as follows:

CW ..... 30 MHz  
 POWER LEVEL ..... -30 dBm

2. Connect the equipment as shown in Figure 4-19. *Option 026:* Use the APC to Type N adapter.

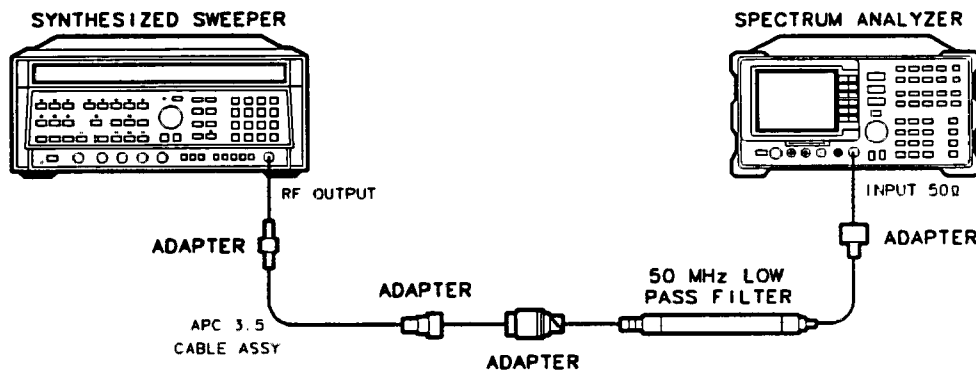

**Figure 4-19. Second Harmonic Distortion Test Setup**

3. Press **PRESET** on the HP 8593A and wait for the preset to finish. Set the controls as follows:

CENTER FREQUENCY ..... 30 MHz  
 SPAN ..... 1 MHz  
 REF LEVEL ..... -30 dBm  
 RES BW ..... 30 kHz

## 16. Spurious Response

4. Adjust the HP 8340A/B power level to place the peak of the signal at the reference level (-30 dBm).

5. Set the HP 8593A control as follows:

RES BW ..... 1 kHz  
VIDEO BW ..... 100 Hz

6. Wait for two sweeps to finish. On the HP 8593A, press **PEAK SEARCH**, **MKR ->**, **MKR -> CF STEP**, **MKR**, **MARKER DELTA**, **FREQUENCY**.

7. Press the **▲** (step up) key on the HP 8593A to step to the second harmonic (at 60 MHz). Set the reference level to -50 dBm. Press **PEAK SEARCH**.

Record the MKR  $\Delta$  Amplitude reading in Table 4-24. The MKR  $\Delta$  Amplitude reading should be less than the specified limit.

### Note



The Max MKR  $\Delta$  Amplitude Reading is 20 dB higher than the specification. This is a result of changing the reference level from -30 dBm to -50 dBm.

## Second Harmonic Distortion, >2.9 GHz

8. Zero and calibrate the HP 8902A and HP 8485A combination in log mode (RF Power readout in dBm). Enter the power sensor's 3 GHz Cal Factor into the HP 8902A.

9. Measure the noise level at 5.6 GHz as follows:

a. Remove any cable or adapters from the HP 8593A INPUT 50 $\Omega$ .

b. Press **PRESET** on the HP 8593A and set the controls as follows:

CENTER FREQUENCY ..... 5.6 GHz  
SPAN ..... 0 Hz  
REF LEVEL ..... -40 dBm  
RES BW ..... 1 kHz  
VID BW ..... 30 Hz  
VIDEO AVERAGE ..... 10  
SWEEP TIME ..... 5.0 s

c. Press **SGL SWP**. Wait until AVG 10 is displayed along the left side of the CRT display. Press **PEAK SEARCH** on the HP 8593A and record the marker amplitude reading as the noise level at 5.6 GHz:

Noise Level at 5.6 GHz \_\_\_\_\_ dBm

10. Press **PRESET** on the HP 8593A. Set the controls as follows:

BAND LOCK ..... 2.75 - 6.4 BAND 1  
CENTER FREQUENCY ..... 2.8 GHz  
SPAN ..... 10 MHz



## 16. Spurious Response

- Connect equipment as shown in Figure 4-20, with the output of the HP 8340A/B connected to the input of the power splitter, and the power splitter outputs connected to the HP 8593A and the Power Sensor. *Option 026:* Use the APC to Type N adapter.

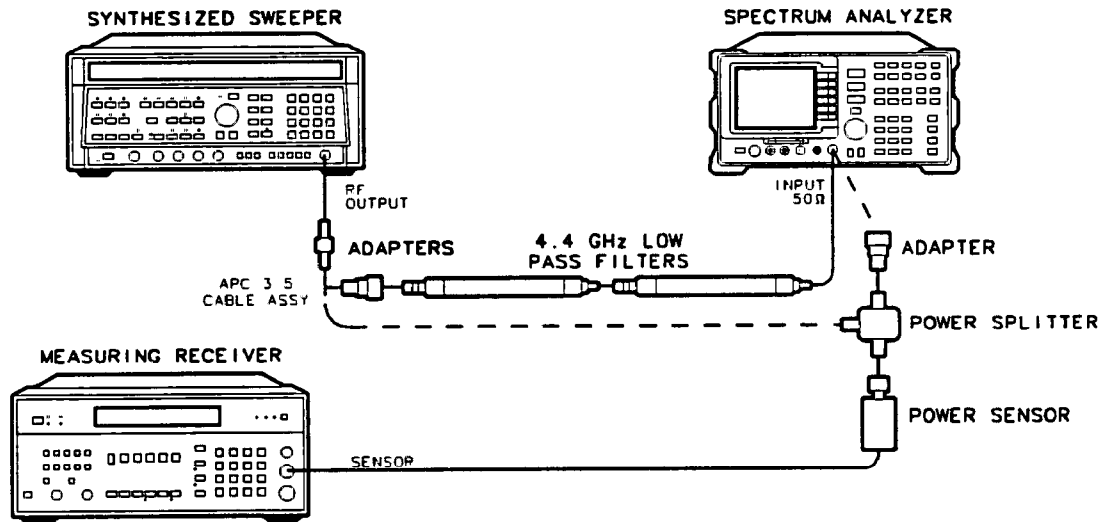

**Figure 4-20. Second Harmonic Distortion Test Setup, >2.9 GHz**

- On the HP 8340A/B, press **PRESET** and set the controls as follows:
 

CW .....	2.8 GHz
POWER LEVEL .....	0 dBm
- On the HP 8593A, press **PEAK SEARCH**, **AMPLITUDE**, **PRESEL PEAK**.  
Wait for the CAL: PEAKING message to disappear. Press **PEAK SEARCH**, **MARKER DELTA**.
- Note the power meter reading:
 

Power Meter Reading at 2.8 GHz \_\_\_\_\_ dBm
- Set the HP 8340A/B CW to 5.6 GHz.
- Set the HP 8593A Center Frequency to 5.6 GHz. Press **PEAK SEARCH**, **AMPLITUDE**, **PRESEL PEAK**. Wait for the CAL: PEAKING message to disappear. Press **PEAK SEARCH**, **SIGNAL TRACK** (ON).
- Adjust the HP 8340A/B power level until the Marker  $\Delta$  Amplitude reads 0 dB  $\pm$ 0.20 dB.
- Enter the power sensor's 6 GHz Cal Factor into the power meter. Note the power meter reading:

Power Meter Reading at 5.6 GHz \_\_\_\_\_ dBm

**16. Spurious Response**

19. Subtract the reading in step 18 from the reading in step 13 and record as the Frequency Response Error. For example, if the reading in step 18 is -6.45 dBm and the reading in step 13 is -7.05 dBm, the Frequency Response Error would be  $-7.05 \text{ dBm} - (-6.45 \text{ dBm}) = -0.60 \text{ dB}$ .

Frequency Response Error (FRE) \_\_\_\_\_ dB

20. Calculate the desired maximum marker amplitude reading as follows:
- a. Add Frequency Response Error, FRE, (step 19) to -60 dBc (specification is -100 dBc, but reference level will be changed by 40 dB to yield the required dynamic range) and record below:

$$\text{Distortion-limited Specification} = -60 \text{ dBc} + \text{FRE}$$

Distortion-limited Specification \_\_\_\_\_ dBc

- b. Subtract -40 dBm (reference level setting) from Noise Level at 5.6 GHz (step 9) and record below:

$$\text{Noise-limited Specification} = \text{Noise Level at 5.6 GHz} + 40 \text{ dBm}$$

Noise-limited Specification \_\_\_\_\_ dBc

- c. Record the more positive of the values recorded in a and b above. For example, if the value in a is -59 dBc and the value in b is -61 dBc, record -59 dBc.

Specification \_\_\_\_\_ dBc

21. Connect the equipment as shown in Figure 4-20 with the filters in place.
22. Set the HP 8340A/B controls as follows:
- CW ..... 2.8 GHz  
POWER LEVEL ..... 0 dBm
23. On the HP 8593A, set the Center Frequency to 2.8 GHz. Press **MKR**, **MARKERS OFF**, **PEAK SEARCH**, **AMPLITUDE**, **PRESEL PEAK**. Wait for the CAL: PEAKING message to disappear. Press **SIGNAL TRACK** (ON), **SPAN** 100 **kHz**.
24. Adjust the HP 8340A/B power level for an HP 8593A marker amplitude reading of 0 dBm  $\pm 0.2$  dB.
25. On the HP 8593A, press **SIGNAL TRACK** (OFF), **PEAK SEARCH**, **MARKER DELTA**. Set controls as follows:

CENTER FREQUENCY ..... 5.6 GHz  
SPAN ..... 10 MHz

## 16. Spurious Response

26. Remove the filters and connect the HP 8340A/B output directly to the HP 8593A INPUT 50Ω.
27. On the HP 8593A, press **PEAK SEARCH**, **AMPLITUDE**, **PRESEL PEAK**. Wait for the **CAL: PEAKING** message to disappear. Press **SIGNAL TRACK** (ON), **SPAN** 100 (kHz).
28. Reinstall the filters between the HP 8340A/B output and the HP 8593A INPUT 50Ω.
29. Set the HP 8593A controls as follows:

REF LEVEL ..... -40 dBm  
 VID BW ..... 30 Hz  
 VIDEO AVERAGE ..... 10

Press **SGL SWP**. Wait until **AVG 10** is displayed along the left side of the CRT display.  
 Press **PEAK SEARCH**. Record the Marker Amplitude Reading below:

Marker Amplitude Reading \_\_\_\_\_ dBc

30. The Marker Amplitude Reading should be more negative than the Specification recorded in step 20c. Record both the Specification from step 20c and the Marker Amplitude Reading in step 29 in Table 4-24. Also record the Specification from step 20c in the Performance Test Record.

**Table 4-24. Second Harmonic Distortion**

Input CW Frequency	MKR Δ Reading	
	Actual (dBc)	Max (dBc)
30	_____	-50
2800	_____	_____ (from Step 20c)

### Third Order Intermodulation Distortion, <2.9 GHz

31. Zero and calibrate the HP 8902A and HP 8485A combination in log mode (RF power readout in dBm). Enter the power sensor's 3 GHz Cal Factor into the HP 8902A.
32. Connect the equipment as shown in Figure 4-21 with the input of the directional coupler connected to the power sensor.

## 16. Spurious Response

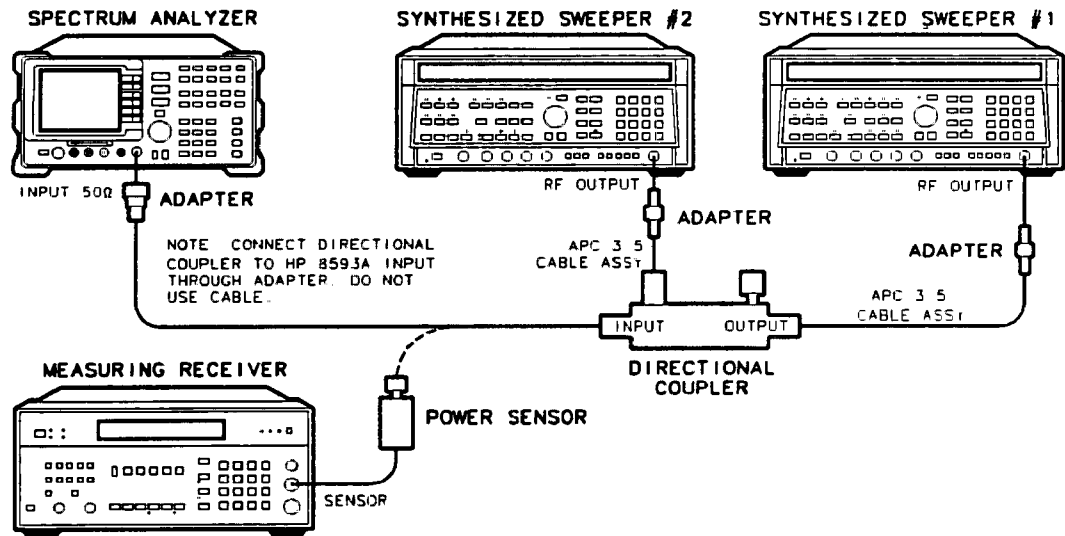

Figure 4-21. Third-Order Intermodulation Distortion Test Setup

33. Press **INSTR PRESET** on each HP 8340A/B. Set each of the HP 8340A/B controls as follows:

POWER LEVEL ..... -15 dBm  
 CW (HP 8340A/B #1) ..... 2.800 GHz  
 CW (HP 8340A/B #2) ..... 2.80005 GHz  
 RF ..... OFF

34. On the HP 8593A, press **PRESET** and wait until the preset is finished. Set the controls as follows:

CENTER FREQUENCY ..... 2.8 GHz  
 SPAN ..... 1 MHz  
 REF LEVEL ..... -10 dBm

Press the following analyzer keys:

**PEAK SEARCH**, **PEAK EXCURSN 3 dB**  
**DISPLAY THRESHLD ON OFF (ON)** **-** 90 **dBm**.

35. On HP 8340A/B #1, set RF on. Adjust the power level until the HP 8902A reads -12 dBm  $\pm$ 0.05 dB.
36. Disconnect the power sensor from the directional coupler. Connect the directional coupler directly to the HP 8593A INPUT 50 $\Omega$  using an adapter (do not use a cable).
37. On the HP 8593A, press **PEAK SEARCH**, **SIGNAL TRACK (ON)**, **SPAN**, 200 **kHz**.  
 Wait for the AUTO ZOOM message to disappear. Press **SIGNAL TRACK (OFF)**, **FREQUENCY**, **▲** (step-up key), **PEAK SEARCH**, **MKR ->**, **MARKER -> REF LVL**.
38. On HP 8340A/B #2, set RF on. Adjust the power level until the two signals are displayed at the same amplitude.

## 16. Spurious Response

39. If necessary, adjust the HP 8593A Center Frequency until the two signals are centered on the display. Set the controls as follows:

RES BW ..... 1 kHz  
 VIDEO BW ..... 100 Hz

40. Press **PEAK SEARCH**, **MARKER DELTA**. Press the following analyzer keys: **DISPLAY**, **DSP LINE ON OFF (ON)**. Set the display line to a value 54 dB below the current reference level setting.
41. The third order intermodulation distortion products should appear 50 kHz below the lower frequency signal and 50 kHz above the higher frequency signal. Their amplitude should be less than the display line. See Figure 4-22.

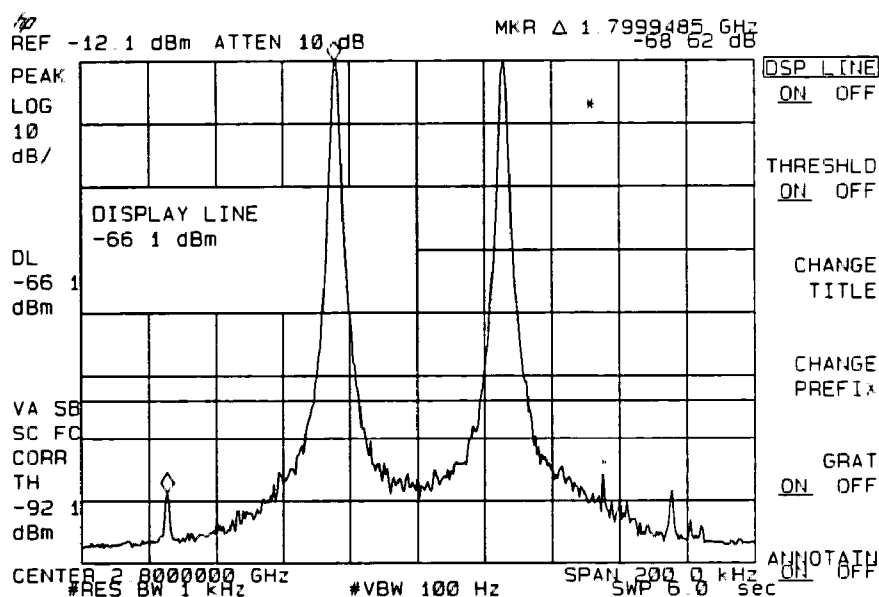

**Figure 4-22. Third Order Intermodulation Distortion**

42. If the distortion products can be seen, proceed as follows:
- On the HP 8593A, press **MKR ->** and **PEAK MENU**.
  - Repeatedly press **NEXT PEAK** until the active marker is on the desired distortion product.
  - Record the MKR Δ amplitude reading in Table 4-25. The MKR Δ reading should be less than the specified limit.
43. If the distortion products cannot be seen, proceed as follows:
- On each HP 8340A/B, increase the power level by 5 dB. Distortion products should now be visible at this higher power level.
  - On the HP 8593A, press **MKR ▶** and **PEAK MENU**.
  - Repeatedly press **NEXT PEAK** until the active marker is on one of the distortion products.

## 16. Spurious Response

- d. On each HP 8340A/B, reduce the power level by 5 dB and wait for completion of a new sweep.
- e. Record the MKR  $\Delta$  amplitude reading in Table 4-25. The MKR  $\Delta$  reading should be less than the specified limit.

### Third Order Intermodulation Distortion, >2.9 GHz

44. Enter the Power Sensor's 4 GHz Cal Factor into the HP 8902A.
45. Disconnect the directional coupler from the HP 8593A and connect the power sensor to the output of the directional coupler.
46. Set each of the HP 8340A/B controls as follows:  
POWER LEVEL ..... -15 dBm  
CW (HP 8340A/B #1) ..... 4.000 GHz  
CW (HP 8340A/B #2) ..... 4.00005 GHz  
RF ..... OFF
47. On the HP 8593A, press **PRESET** and wait until the preset is finished. Set the controls as follows:  
CENTER FREQUENCY ..... 4.0 GHz  
SPAN ..... 1 MHz  
REF LEVEL ..... -10 dBm  
PEAK EXCURSION ..... 3 dB  
THRESHOLD ..... -90 dBm
48. On HP 8340A/B #1, set RF on. Adjust the power level until the HP 8902A reads -12 dBm  $\pm$ 0.05 dB.
49. Disconnect the power sensor from the directional coupler. Connect the directional coupler directly to the HP 8593A INPUT 50 $\Omega$  using an adapter (do not use a cable).
50. On the HP 8593A, press **PEAK SEARCH**, **AMPLITUDE**, **PRESEL PEAK**. Wait for the CAL: PEAKING message to disappear. Press the following keys:  
**SIGNAL TRACK** (ON)  
**SPAN** 200 **kHz**.  
Wait for the AUTO ZOOM message to disappear. Press **SIGNAL TRACK** (OFF), **FREQUENCY**, **▲** (step-up key), **PEAK SEARCH**, **MKR ->**, **MARKER -> REF LVL**.
51. On HP 8340A/B #2, set RF on. Adjust the power level until the two signals are displayed at the same amplitude.
52. If necessary, adjust the HP 8593A Center Frequency until the two signals are centered on the display. Set the controls as follows:  
RES BW ..... 1 kHz  
VIDEO BW ..... 100 Hz
53. Press **PEAK SEARCH**, **MARKER DELTA**. Set the DISPLAY LINE to a value 54 dB below the current reference level setting.

## 16. Spurious Response

54. The third order intermodulation distortion products should appear 50 kHz below the lower frequency signal and 50 kHz above the higher frequency signal. Their amplitude should be less than the display line. See Figure 4-22.
55. If the distortion products can be seen, proceed as follows:
  - a. On the HP 8593A, press **MKR ▸** and **PEAK MENU**.
  - b. Repeatedly press **NEXT PEAK** until the active marker is on the desired distortion product.
  - c. Record the MKR  $\Delta$  amplitude reading in Table 4-25. The MKR  $\Delta$  reading should be less than the specified limit.
56. If the distortion products cannot be seen, proceed as follows:
  - a. On each HP 8340A/B, increase the power level by 5 dB. Distortion products should now be visible at this higher power level.
  - b. On the HP 8593A, press **MKR ▸** and **PEAK MENU**.
  - c. Repeatedly press **NEXT PEAK** until the active marker is on one of the distortion products.
  - d. On each HP 8340A/B, reduce the power level by 5 dB and wait for completion of a new sweep.
  - e. Record the MKR  $\Delta$  amplitude reading in Table 4-25. The MKR  $\Delta$  reading should be less than the specified limit.

**Table 4-25. Third Order Intermodulation Distortion**

HP 8340A/B #1 CW Frequency	HP 8340A/B #2 CW Frequency	MKR $\Delta$ Amplitude Reading	
		(dBc)	(dBc)
2.80000	2.80005	_____	-54
4.00000	4.00005	_____	-54

---

## 17. Gain Compression

### Specification

>10 MHz  $\leq$ 0.5 dB for -10 dBm total power at input mixer.

### Description

This test measures gain compression in both low band and high band. Two signals, separated by 3 MHz, are used. First, the test places a -30 dBm signal at the input of the spectrum analyzer (the analyzer's reference level is also set to -30 dBm). Then, a 0 dBm signal is applied to the analyzer, overdriving its input. The decrease in the first signal's amplitude (gain compression) caused by the second signal is the measured gain compression.

### Equipment

Synthesized Sweeper (2 required) .....	HP 8340A/B
Measuring Receiver (used as a power meter) .....	HP 8902A
Power Sensor .....	HP 8485A
Directional Coupler .....	0955-0125

### Cables

APC 3.5, 91 cm (36 in) (2 required) .....	8120-4921
---	-----------

### Adapters

Type N (m) to APC 3.5 (m) .....	1250-1743
APC 3.5 (f) to APC 3.5 (f) (2 required) .....	5061-5311

### Procedure

#### <2.9 GHz

1. Zero and calibrate the HP 8902A and HP 8585A combination in log mode (power reads out in dBm). Enter the power sensor's 2 GHz Cal Factor into the HP 8902A.
2. Connect the equipment as shown in Figure 4-23, with the output of the directional coupler connected to the power sensor. *Option 026:* Connect the directional coupler to the analyzer input directly.



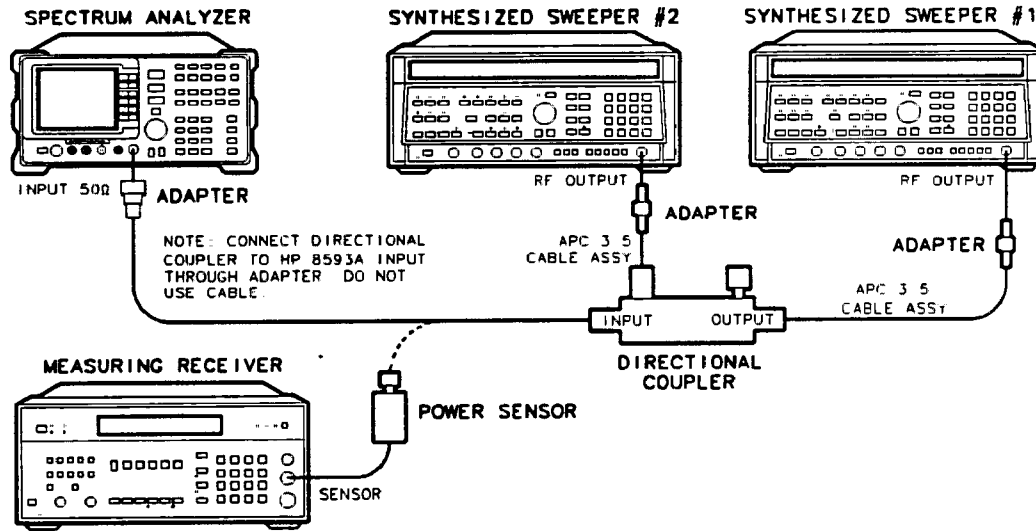

Figure 4-23. Gain Compression Test Setup

3. Press **INSTR PRESET** on each HP 8340A/B. Set the HP 8340A/B #1 controls as follows:
  - CW ..... 2.003 GHz
  - POWER LEVEL ..... 0 dBm
4. Set the HP 8340A/B #2 controls as follows:
  - CW ..... 2.0 GHz
  - POWER LEVEL ..... -14 dBm
5. On the HP 8593A, press **PRESET** and wait for the preset to finish. Set the controls as follows:
  - CENTER FREQUENCY ..... 2.0 GHz
  - SPAN ..... 20 MHz
  - REF LEVEL ..... -30 dBm
  - LOG dB/DIV ..... 1 dB
  - RES BW ..... 300 kHz
6. On HP 8340A/B #1, adjust the power level for a 0 dBm reading on the HP 8902A. Set RF to off.

---

**Note** The power level applied to the spectrum analyzer input is 10 dB greater than the specification to account for the 10 dB ATTEN setting. A power level of 0 dBm at the analyzer input yields -10 dBm at the input mixer.

---

7. Disconnect the power sensor from the directional coupler and connect the directional coupler to the INPUT 50Ω connector of the spectrum analyzer using an adapter. Do not use a cable.

## 17. Gain Compression

8. On the HP 8593A, press the following keys:

**PEAK SEARCH** **SIGNAL TRACK** (ON)  
**SPAN** 10 **MHz**.

Wait for the AUTO ZOOM message to disappear.

9. On HP 8340A/B #2, adjust the power level to place the signal 1 dB below the analyzer's reference level.
10. On the HP 8593A, press **PEAK SEARCH**, **MARKER DELTA**.
11. On HP 8340A/B #1, set RF to on.
12. On the HP 8593A, press **PEAK SEARCH**, **NEXT PEAK**. The active marker should be on the lower amplitude signal and not on the signal that is off the top of the screen. If it is not on the lower amplitude signal, reposition the marker to this peak using the analyzer's knob.
13. Read the MKR  $\Delta$  amplitude and record the amplitude in Table 4-26. The absolute value of this amplitude should be less than or equal to 0.5 dB.

### >2.9 GHz

14. Disconnect the directional coupler from the input to the spectrum analyzer and connect the directional coupler to the power sensor.
15. Set the HP 8593A controls as follows:  
CENTER FREQUENCY ..... 4.0 GHz  
SPAN ..... 20 MHz  
MKR ..... OFF
16. Set HP 8340A/B #1 controls as follows:  
CW ..... 4.003 GHz  
POWER LEVEL ..... 2 dBm
17. Set HP 8340A/B #2 controls as follows:  
CW ..... 4.0 GHz  
POWER LEVEL ..... -14 dBm
18. Enter the power sensor's 4 GHz Cal Factor into the HP 8902A.
19. Adjust HP 8340A/B #1 power level for a 0 dBm reading on the HP 8902A. Set RF to off.
20. Disconnect the power sensor from the directional coupler and connect the directional coupler to the input of the spectrum analyzer using an adapter. Do not use a cable.

21. On the HP 8593A, press the following keys:

**PEAK SEARCH** **SIGNAL TRACK** (ON).

Wait for the signal to be centered on screen. Press **AMPLITUDE**, **PRESEL PEAK** and wait for the **CAL: PEAKING** message to disappear.

Press **SPAN** 10 **MHz**. Wait for the **AUTO ZOOM** message to disappear.

22. On HP 8340A/B #2, adjust the power level to place the signal 1 dB below the analyzer's reference level.
23. On the HP 8593A, press **PEAK SEARCH**, **MARKER DELTA**.
24. Set HP 8340A/B #1 RF to on.
25. On the HP 8593A, press **PEAK SEARCH**, **NEXT PEAK**. The active marker should be on the lower amplitude signal and not on the signal that is off the top of the screen. If it is not on the lower amplitude signal, reposition the marker to this peak using the analyzer's knob.
26. Read the **MKR Δ** amplitude and record the amplitude in Table 4-26. The absolute value of this amplitude should be less than or equal to 0.5 dB.

**Table 4-26. Gain Compression**

Band	HP 8593A Center Frequency	HP 8340A/B #1 CW Frequency (GHz)	HP 8340A/B #2 CW Frequency (GHz)	Gain Compression (dB)
0	2.0 GHz	2.003	2.000	_____
1	4.0 GHz	4.003	4.000	_____

## 18. Displayed Average Noise Level

### Specification

#### Displayed Average Noise Level

400 kHz to 2.9 GHz	$\leq -112$ dBm
2.75 to 6.4 GHz	$\leq -114$ dBm
6.0 to 12.8 GHz	$\leq -102$ dBm
12.4 to 19.4 GHz	$\leq -98$ dBm
19.1 to 22 GHz	$\leq -92$ dBm
19.1 to 26.5 GHz ( <i>Option 026</i> )	$\leq -87$ dBm

### Description

This test measures the displayed average noise level in all five frequency bands. The analyzer's input is terminated in  $50\Omega$ . In Band 0 (9 kHz to 2.9 GHz), the test first measures the average noise at 400 kHz and 1 MHz in zero span. The LO feedthrough is used as a frequency reference for these measurements. For the rest of Band 0 and for all of the remaining bands, the test tunes the analyzer frequency across the band, uses the marker to locate the frequency with the highest response, and then reads the average noise in zero span.

To reduce measurement uncertainty due to input attenuator switching and resolution bandwidth switching, a reference level offset is added. The CAL OUT signal is used as the amplitude reference for determining the amount of offset required. The offset is removed at the end of the test by pressing **PRESET**.

### Equipment

#### Cable

BNC, 23 cm (9 in) ..... HP 10502A

#### Adapters

50 $\Omega$  Termination ..... HP 909D

Type N (m) to BNC (f) ..... 1250-1476

Type N (m) to APC 3.5 (f) ..... 1250-1744

#### Additional Equipment for Option 026

Adapter, APC 3.5 (f) to APC 3.5 (f) ..... 5061-5311

Adapter, BNC (m) to SMA (f) ..... 1250-1700

Cable, Cal Comb ..... 08592-60061

**Procedure**

1. Connect a cable from the CAL OUT to the INPUT 50Ω of the HP 8593A as shown in Figure 4-24. (*Option 026:* Use the BNC to SMA adapter to connect the cal comb cable to CAL OUT. Use the APC 3.5 adapter to connect the cal cable to the INPUT 50Ω.)

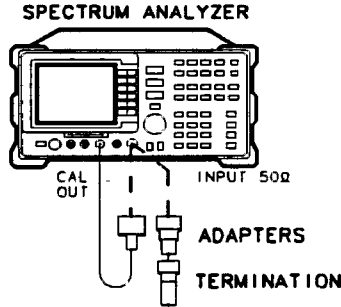

**Figure 4-24. Reference Offset Test Setup**

Press **PRESET** and wait for the preset to finish. Set the controls as follows:

CENTER FREQUENCY ..... 300 MHz  
 SPAN ..... 10 MHz  
 REF LEVEL ..... -20 dBm  
 ATTEN ..... 0 dB

2. Press the following analyzer keys:

**PEAK SEARCH** **SIGNAL TRACK** (ON)  
**SPAN** 100 (kHz).

Wait for the AUTO ZOOM message to disappear. Set the controls as follows:

VIDEO BW ..... 30 Hz  
 TRIGGER ..... SINGLE  
 SIGNAL TRACK ..... OFF

3. Press **SGL SWP** and wait for completion of a new sweep. Press the following analyzer keys:

**PEAK SEARCH** **AMPLITUDE** MORE 1 of 2  
 REF LVL OFFSET .

Subtract the MKR amplitude reading from -20 dBm and enter the result as the REF LVL OFFSET. For example, if the marker reads -20.21 dBm, enter +0.21 dB (-20 dBm - (-20.21 dBm) = +0.21 dB).

REF LVL OFFSET \_\_\_\_\_ dB

**18. Displayed Average Noise Level**

- 4. Disconnect the cable from the INPUT 50Ω connector of the HP 8593A. Connect the 50Ω termination to the analyzer INPUT 50Ω connector.

**400 kHz**

- 5. Press the following analyzer keys:

**VID BW AUTO MAN (AUTO).**

Set the analyzer's controls as follows:

CENTER FREQUENCY ..... 0 Hz  
SPAN ..... 10 MHz  
REF LEVEL ..... -10 dBm  
TRIGGER ..... CONT

- 6. Press the following analyzer keys:

**PEAK SEARCH** **SIGNAL TRACK** (on)  
**SPAN** 800 **kHz**.

Wait for the AUTO ZOOM message to disappear.

Press the following analyzer keys:

**SIGNAL TRACK** (OFF) **BW** 3 **kHz**  
**FREQUENCY**.

- 7. Adjust the Center Frequency until the LO feedthrough peak is on the left-most graticule line. Set the controls as follows:

SPAN ..... 50 kHz  
REF LEVEL ..... -50 dBm  
RES BW ..... 1 kHz  
VIDEO BW ..... 30 Hz  
SWEEP TIME ..... 5 s

- 8. Press **TRACE**, **MORE 1 of 3**, **DETECTOR SAMPL PK (SAMPL)**, **SGL SWP**.

Wait for completion of a new sweep.

- 9. Press the following analyzer keys:

**DISPLAY** **DSP LINE ON OFF (ON).**

Adjust the display line so that it is centered on the average noise trace, ignoring any residual responses (refer to Residual Response verification test for any suspected residuals).

Record the display line amplitude setting in Table 4-27 as the Noise Level at 400 kHz. The average noise level should be less than the specified limit.

## 18. Displayed Average Noise Level

1 MHz

10. Press the following analyzer keys:

**AUTO COUPLE** RES BW AUTO MAN (AUTO)  
VID BW AUTO MAN (AUTO)

Set the analyzer's controls as follows:

CENTER FREQUENCY ..... 0 MHz  
SPAN ..... 10 MHz  
REF LEVEL ..... -10 dBm  
TRIGGER ..... CONT

11. Press the following analyzer keys:

**PEAK SEARCH** **SIGNAL TRACK** (ON)  
**SPAN** 2 **MHz**.

Wait for the AUTO ZOOM message to disappear. Press the following analyzer key:

**SIGNAL TRACK** (OFF).

12. Press **FREQUENCY**, and adjust the center frequency until the LO feedthrough peak is on the left-most graticule line. Set the controls as follows:

SPAN ..... 50 kHz  
REF LEVEL ..... -50 dBm  
RES BW ..... 1 kHz  
VIDEO BW ..... 30 Hz

13. Press the following analyzer keys:

**SGL SWP**.

Wait for completion of a new sweep.

14. Press the following analyzer keys:

**DISPLAY** DSP LINE ON OFF (ON).

Adjust the display line so that it is centered on the average noise trace, ignoring any residual responses (refer to Residual Response verification test for any suspected residuals).

Record the display line amplitude setting in Table 4-27. The average noise level should be less than the specified limit.

## 18. Displayed Average Noise Level

1 MHz to 2.9 GHz

15. Press the following analyzer keys:

**SPAN** BAND LOCK 0-2.9 Gz BAND 0 .

Set the controls as follows:

RES BW ..... 1 MHz  
VIDEO BW ..... 10 kHz  
TRIGGER ..... CONT

16. Adjust the START FREQ setting, if necessary, to place the LO feedthrough just off-screen to the left.

17. Press the following analyzer keys:

**SGL SWP**

**TRACE** CLEAR WRITE A MORE 1 of 3

VID AVG ON OFF (ON) 10 **Hz**.

Wait until AVG 10 is displayed to the left of the graticule (the analyzer will take ten sweeps, then stop).

18. Press **PEAK SEARCH** and record the MKR frequency as the Measurement Frequency in the appropriate band under test.

19. Press the following analyzer keys:

**TRACE** MORE 1 of 3 VID AVG (OFF) **AUTO COUPLE** RES BW AUTO MAN (AUTO)

VID BW AUTO MAN (AUTO)

**SPAN** 50 **kHz** **FREQUENCY**.

Set the CENTER FREQ to the Measurement Frequency recorded in Table 4-27 for the appropriate band under test. Set the controls as follows:

RES BW ..... 1 kHz  
VIDEO BW ..... 30 Hz

20. Press **SGL SWP**.

Wait for a new sweep to finish. Press the following analyzer keys:

**DISPLAY** DSP LINE ON OFF (ON).

Adjust the display line so that it is centered on the average noise trace, ignoring any residual responses (refer to Residual Response verification test for any suspected residuals).

Record the display line amplitude setting in Table 4-27. The average noise level should be less than the specified limit.

21. Press **MARKERS OFF** .



2.75 to 6.4 GHz

22. Press the following analyzer keys:

**SPAN** BAND LOCK 2.75-6.4 BAND 1.

Set the controls as follows:

RES BW .....	1 MHz
VIDEO BW .....	10 kHz
TRIGGER .....	CONT

23. Repeat steps 17 through 21 above for Band 1 (2.75 to 6.4 GHz).

6.0 to 12.8 GHz

24. Press the following analyzer keys:

**SPAN** BAND LOCK 6.0-12.8 BAND 2.

Set the controls as follows:

RES BW .....	1 MHz
VIDEO BW .....	10 kHz
TRIGGER .....	CONT

25. Repeat steps 17 through 21 above for Band 2 (6.0 to 12.8 GHz).

12.4 to 19.4 GHz

26. Press the following analyzer keys:

**SPAN** BAND LOCK 12.4-19. BAND 3.

Set the controls as follows:

RES BW .....	1 MHz
VIDEO BW .....	10 kHz
TRIGGER .....	CONT

27. Repeat steps 17 through 21 above for Band 3 (12.4 to 19.4 GHz).

19.1 to 22 GHz

28. Press the following analyzer keys:

**SPAN** BAND LOCK 19.1-22 BAND 4.

**18. Displayed Average Noise Level**

Set the controls as follows:

RES BW ..... 1 MHz  
 VIDEO BW ..... 10 kHz  
 TRIGGER ..... CONT

29. Repeat steps 17 through 21 above for Band 4.

**22 GHz to 26.5 GHz (Option 026)**

30. Press the following analyzer keys:

**SPAN** BAND LOCK 19.1 - 22 BAND 4  
**FREQUENCY** START FREQ 22 **GHz**  
 STOP FREQ 26.5 **GHz**.

31. Set the controls as follows:

RES BW ..... 1 MHz  
 VIDEO BW ..... 10 kHz  
 TRIGGER ..... CONT

32. Repeat steps 17 through 21 for frequencies from 22 to 26.5 GHz.

33. Press **PRESET** on the 8593A and wait for the preset to finish.

**Table 4-27. Displayed Average Noise Level**

Frequency Range	Measurement Frequency	Displayed Average Noise Level (dBm)	Specification (dBm)
400 kHz	400 kHz	_____	-112 dBm
1 MHz	1 MHz	_____	-112 dBm
1 MHz to 2.9 GHz	_____	_____	-112 dBm
2.75 to 6.4 GHz	_____	_____	-114 dBm
6.0 to 12.8 GHz	_____	_____	-102 dBm
12.4 to 19.4 GHz	_____	_____	-98 dBm
19.1 to 22 GHz	_____	_____	-92 dBm
(Option 026: 19.1 to 26.5 GHz)	_____	_____	-87 dBm

## 19. Residual Responses

### Specification

With 0 dB INPUT ATTEN setting and no signal at input:

150 kHz to 2.9 GHz (band 0) < -90 dBm.

2.75 GHz to 6.4 GHz (band 1) < -90 dBm.

### Description

The spectrum analyzer's input is terminated in 50Ω and the analyzer is swept from 150 kHz to 5 MHz. Then the analyzer is swept in 10 MHz spans throughout the 5 MHz to 6.4 GHz range. Any responses above the specification are noted.

### Equipment

50Ω Termination ..... HP 909D

### Adapter

Type N (m) to APC 3.5 (f) ..... 1250-1744

### Additional Equipment for Option 026

Adapter, 3.5 mm (f) to 3.5 mm (f) ..... 5061-5311

### Procedure

#### 150 kHz to 5 MHz

1. Connect the 50Ω Termination to the analyzer's input using an adapter, as shown in Figure 4-25.

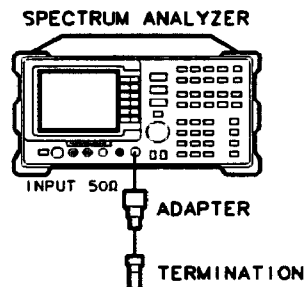

Figure 4-25. Residual Response Test Setup

2. Press **PRESET** on the analyzer and wait for the preset to finish. Press the following analyzer keys:

## 19. Residual Responses

**SPAN** BAND LOCK 0-2.9 Gz BAND 0  
**PEAK SEARCH** **SIGNAL TRACK** (ON) **SPAN** 6 **MHz**.

Wait for the AUTO ZOOM message to disappear.

Press **SIGNAL TRACK** (OFF).

3. Adjust the Center Frequency until the LO feedthrough peak is on the left-most vertical graticule line. Press the following analyzer keys: **PEAK SEARCH**. Set the controls as follows:

MARKER DELTA	.....	150 kHz
MARKER	.....	NORMAL
REF LVL	.....	-60 dBm
ATTEN	.....	0 dB
RES BW	.....	3 kHz
VID BW	.....	1 kHz
DISPLAY LINE	.....	-90 dBm

4. Press **SGL SWP** and wait for a new sweep to finish. Look for any residual responses at or above the display line, to the right of the marker. If a residual is suspected, press **SGL SWP** again. A residual response will persist on successive sweeps, but a noise peak will not. Note the frequency and amplitude of any residual responses above the display line and to the right of the marker in Table 4-28.

### 5 MHz to 2.75 GHz

5. Press **PRESET** on the HP 8593A and wait for the preset to finish. Set the controls as follows:

BAND LOCK	.....	0 - 2.9 Gz BAND 0
CENTER FREQUENCY	.....	10 MHz
SPAN	.....	10 MHz

6. Set the controls as follows:

SPAN	.....	10 MHz
CF STEP SIZE	.....	9.8 MHz
REF LEVEL	.....	-60 dBm
ATTEN	.....	0 dBm
RES BW	.....	10 kHz
VIDEO BW	.....	3 kHz
DISPLAY LINE	.....	-90 dBm

7. Press **SGL SWP** and wait for a new sweep to finish. Look for any residual responses at or above the display line. If a residual is suspected, press **SGL SWP** again. A residual response will persist on successive sweeps, but a noise peak will not. Note the frequency and amplitude of any residual responses above the display line in Table 4-28.
8. Press **FREQUENCY**, **▲** (step up) key to step to the next frequency and repeat step 7.

**19. Residual Responses**

9. Repeat steps 7 and 8 until the range from 5 MHz to 2.9 GHz has been checked. This requires 295 additional frequency steps. The test for this band requires about 15 minutes to complete if no residuals are found.

**2.75 GHz to 6.4 GHz**

10. Set the HP 8593A controls as follows:

BAND LOCK ..... 2.75-6.4 BAND 1  
 CENTER FREQUENCY ..... 2755 MHz  
 DISPLAY LINE ..... -90 dBm  
 SPAN ..... 10 MHz  
 RES BW ..... 10 kHz  
 VIDEO BW ..... 3 kHz

11. Repeat steps 7 and 8 until the range from 2.75 to 6.4 GHz has been checked. This requires 372 additional frequency steps and takes about 18 minutes to complete if no residuals are found.

**Table 4-28. Residual Responses Above Display Line**

Frequency (GHz)	Amplitude (dBm)
_____	_____
_____	_____
_____	_____
_____	_____
_____	_____

---

## 20. 10 MHz Reference Output Accuracy (Option 004)

### Specification

Aging:

$\pm 1 \times 10^{-7}$  per year

Warmup (Characteristic):

After 5 minutes from cold start \*,  $\pm 1 \times 10^{-7}$  of final stabilized frequency.†

After 30 minutes from cold start \*,  $\pm 1 \times 10^{-8}$  of final stabilized frequency.†

\* A cold start is defined as the analyzer being powered on after being off for at least 60 minutes.

†The final stabilized frequency is the frequency 60 minutes after being powered on.

### Related Adjustment

10 MHz Reference Adjustment (Option 004).

### Description

This test measures the warmup characteristics of the 10 MHz reference oscillator. The ability of the 10 MHz oscillator to meet its warmup characteristics gives a high level of confidence that it will also meet its yearly aging specification.

A frequency counter is connected to the 10 MHz REF OUTPUT. After the analyzer has been allowed to cool for at least 60 minutes, the analyzer is powered on. A frequency measurement is made 5 minutes after power is applied and the frequency is recorded. Another frequency measurement is made 25 minutes later (30 minutes after power is applied) and the frequency is recorded. A final frequency measurement is made 60 minutes after power is applied. The difference between each of the first two frequency measurements and the last frequency measurement is calculated and recorded.

### Equipment

Frequency Counter ..... HP 5334A/B  
Frequency Standard—any 10 MHz frequency standard with aging rate  
of  $< \pm 1 \times 10^{-10}$  per day such as the HP 5061B Cesium Beam Standard  
BNC Cable, 122 cm (48 in) (2 required) ..... HP 10503A

---

### Note



The spectrum analyzer must have been allowed to sit with the power off for at least 60 minutes before beginning this test. This adequately simulates a cold start.

---

## 20. 10 MHz Reference Output Accuracy (Option 004)

### Procedure

1. Allow the spectrum analyzer to sit with the power off for at least 60 minutes before proceeding. Connect the equipment as shown in Figure 4-26.

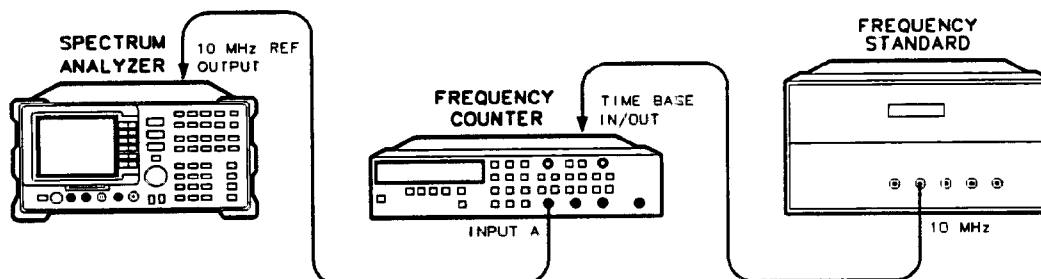

Figure 4-26. 10 MHz Reference Accuracy Test Setup, Option 004

2. Set the spectrum analyzer LINE switch on. Record the Power On Time below.

Power On Time \_\_\_\_\_

3. Set the counter controls as follows:

FUNCTION/DATA .....	FREQ A
INPUT A	
X10 ATTN .....	OFF
AC .....	OFF
50Ω Z .....	OFF
AUTO TRIG .....	ON
100 kHz FILTER A .....	OFF

4. On the frequency counter select a 10 second gate time by pressing **GATE TIME**, 10 **GATE TIME**. Offset the displayed frequency by -10.0 MHz by pressing **MATH SELECT/ENTER**, **CHS/EEX**, 10 **CHS/EEX**, 6 **SELECT/ENTER**, **SELECT ENTER**. The frequency counter should now display the difference between the INPUT A signal and 10.0 MHz with 0.001 Hz resolution.
5. Proceed with the next step 5 minutes after the Power On Time noted in step 2.
6. Wait at least two periods for the frequency counter to settle. Record the frequency counter reading below as Reading 1 with 0.001 Hz resolution.

Reading 1 \_\_\_\_\_ Hz

7. Proceed with the next step 15 minutes after the Power On Time noted in step 2.

**20. 10 MHz Reference Output Accuracy (Option 004)**

8. Record the frequency counter reading below as Reading 2 with 0.001 Hz resolution.

Reading 2 \_\_\_\_\_ Hz

9. Proceed with the next step 60 minutes after the Power On Time noted in step 2.

10. Wait at least two periods for the frequency counter to settle. Record the frequency counter reading below as Reading 3 with 0.001 Hz resolution.

Reading 3 \_\_\_\_\_ Hz

11. Calculate the 5 Minute Warmup Error by subtracting Reading 3 from Reading 1 and dividing the result by 10 MHz.

$$5 \text{ Minute Warmup Error} = (\text{Reading 1} - \text{Reading 3}) / (10.0 \times 10^6)$$

5 Minute Warmup Error \_\_\_\_\_

12. Calculate the 30 Minute Warmup Error by subtracting Reading 3 from Reading 2 and dividing the result by 10 MHz.

$$30 \text{ Minute Warmup Error} = (\text{Reading 2} - \text{Reading 3}) / (10.0 \times 10^6)$$

30 Minute Warmup Error \_\_\_\_\_



## 21. Fast Time Domain Sweeps (Option 101)

### Specification

From 20 Milliseconds to 20 Microseconds, Zero SPAN mode:

Sweep Time Accuracy:  $\pm 2\%$ .

Amplitude Resolution: 0.7% of reference level for linear scale.

### Description

The CAL OUT signal is used to compare the amplitude level of a normal sweep time (20 ms) to a fast sweep time (18 ms) using the marker delta function.

A synthesizer/level generator is used to amplitude modulate a 500 MHz, CW signal from another signal generator. The analyzer demodulates this signal in zero span to display the response in the time domain. The marker delta frequency function on the analyzer is used to read out the sweep time.

### Equipment

Synthesizer/Function Generator .....	HP 3335A
Signal Generator .....	HP 8640B

#### Cables

BNC, 122 cm (48 in) .....	HP 10503A
BNC, 23 cm (9 in) .....	HP 10502A
Type N Cable, 152 cm (60 in) .....	HP 11500D

#### Adapter

Type N (m) to BNC (f) .....	1250-1476
-----------------------------	-----------

### Additional Equipment for Option 026

Adapter, APC 3.5 (f) to N (f) .....	1250-1745
-------------------------------------	-----------

### Procedure

#### Fast Sweep Time Amplitude Accuracy

1. Connect the equipment as shown in Figure 4-27. *Option 026:* Use the APC to Type N adapter with the Type N to BNC adapter.

## 21. Fast Time Domain Sweeps (Option 101)

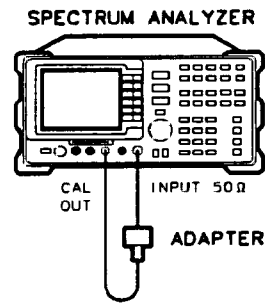

**Figure 4-27. Fast Sweep Time Amplitude Test Setup**

- On the analyzer, press **PRESET** and wait for the preset to finish. Set the controls as follows:

FREQUENCY .....	300 MHz
SPAN .....	0 Hz
SWEEP .....	20 ms
SCALE .....	LINEAR
REF LEVEL .....	25 mV

Press the following analyzer keys:

**MKR** MKNOISE ON OFF (ON).

- Press **SGL SWP**. Then press **MARKER DELTA**.
- Set the sweep time to 18 ms. Press **SGL SWP** and read the MKR  $\Delta$  amplitude. The amplitude should be within the following limits.

$$1.007X \leq \text{_____} \leq 0.993X$$

### Fast Sweep Time Accuracy

- Connect the equipment as shown in Figure 4-28. *Option 026:* Use the APC to Type N adapter.

## 21. Fast Time Domain Sweeps (Option 101)

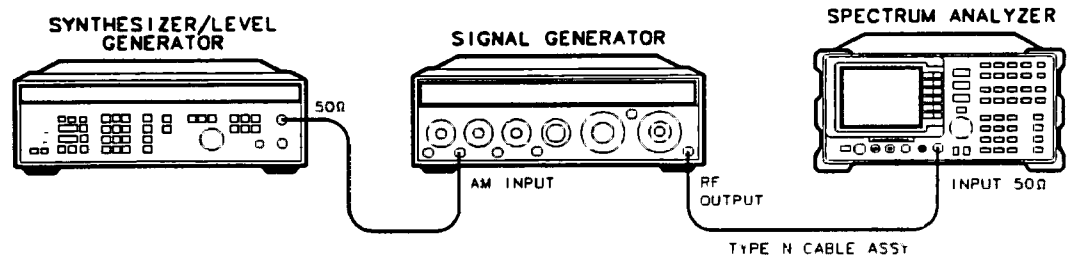

**Figure 4-28. Fast Sweep Time Test Setup**

6. Set the signal generator to output a 300 MHz,  $-4$  dBm, CW signal. Set the AM and FM controls off.
7. Set the synthesizer/level generator to output a 556 Hz,  $+5$  dBm, signal.
8. Press **PRESET** on the analyzer and wait for the preset to finish. Set the controls as follows:
 

FREQUENCY .....	300 MHz
SPAN .....	0 Hz
9. Set the signal generator AM switch to the AC position. If necessary, adjust the output amplitude of the signal generator to position the top of the modulated waveform approximately one division below top screen.
10. Set the analyzer controls as follows:
 

TRIG .....	VIDEO
SWEEP .....	18 ms
11. Press **SGL SWP**.
12. Press **PEAK SEARCH**. If necessary, press **NEXT PEAK** until the marker is on the left-most complete signal peak. This is the "marked signal."
13. Press **MARKER DELTA**, **MARKER DELTA** and press **NEXT PK RIGHT** until the marker delta is on eighth signal.
14. Record the MKR  $\Delta$  frequency reading in Table 4-29. The MKR reading should be within the limits shown.
15. Repeat steps 11 through 15 for the remaining sweep time settings listed in Table 4-29.

21. Fast Time Domain Sweeps (Option 101)

Table 4-29. Fast Sweep Time Accuracy

Analyzer Sweep Time	HP 3335A Frequency	Minimum Reading	MKR $\Delta$	Maximum Reading
18 ms	556 Hz	14.04 ms	_____	14.76 ms
10 ms	1 kHz	7.8 ms	_____	8.2 ms
5 ms	2 kHz	3.9 ms	_____	4.1 ms
2 ms	5 kHz	1.56 ms	_____	1.64 ms
1.0 ms	10 kHz	780 $\mu$ s	_____	820 $\mu$ s
500 $\mu$ s	20 kHz	390 $\mu$ s	_____	410 $\mu$ s
200 $\mu$ s	50 kHz	156 $\mu$ s	_____	164 $\mu$ s
100 $\mu$ s	100 kHz	78 $\mu$ s	_____	82 $\mu$ s
60 $\mu$ s	167 kHz	46.8 $\mu$ s	_____	49.2 $\mu$ s
40 $\mu$ s	250 kHz	31.2 $\mu$ s	_____	32.8 $\mu$ s
20 $\mu$ s	500 kHz	15.6 $\mu$ s	_____	16.4 $\mu$ s

**Performance Verification Test Record**

**Table 4-30. Performance Verification Test Record (Page 1 of 9)**

Hewlett-Packard Company			
Address: _____		Report No. _____	
_____		Date _____	
_____		(e.g. 10 SEP 1989)	
Model HP 8593A			
Serial No. _____			
Options _____			
Firmware Revision _____			
Customer _____		Tested by _____	
Ambient temperature _____ °C		Relative humidity _____ %	
Power mains line frequency _____ Hz (nominal)			
<b>Test Equipment Used:</b>			
<b>Description</b>	<b>Model No.</b>	<b>Trace No.</b>	<b>Cal Due Date</b>
Synthesized Sweeper #1	_____	_____	_____
Synthesized Sweeper #2	_____	_____	_____
Synthesizer/Function Generator	_____	_____	_____
Synthesizer/Level Generator	_____	_____	_____
AM/FM Signal Generator	_____	_____	_____
Measuring Receiver	_____	_____	_____
Power Meter	_____	_____	_____
RF Power Sensor	_____	_____	_____
High-Sensitivity Power Sensor	_____	_____	_____
Microwave Power Sensor	_____	_____	_____

**Performance Verification Test Record**

**Performance Verification Test Record (Page 2 of 9)**

Hewlett-Packard Company	Report No. _____
Model HP 8593A	
Serial No. _____	Date _____

<b>Test Equipment Used:</b>			
<b>Description</b>	<b>Model No.</b>	<b>Trace No.</b>	<b>Cal Due Date</b>
Microwave Frequency Counter	_____	_____	_____
Universal Frequency Counter	_____	_____	_____
Frequency Standard	_____	_____	_____
Power Splitter	_____	_____	_____
4.4 GHz Low Pass Filters	_____	_____	_____
50 MHz Low Pass Filter	_____	_____	_____
50Ω Termination	_____	_____	_____
<b>Notes/Comments</b>			
_____			
_____			
_____			

Performance Verification Test Record

Performance Verification Test Record (Page 3 of 9)

Hewlett-Packard Company	Report No. _____
Model HP 8593A	
Serial No. _____	Date _____

Test No.	Test Description	Results			Measurement Uncertainty		
		Min	Measured	Max			
1.	<b>10 MHz Reference Accuracy</b> (Standard Timebase) Aging Stability	Frequency Error					
		$-1 \times 10^{-7}$		$+1 \times 10^{-7}$	$\pm 4.7 \times 10^{-9}$		
		$-0.5 \times 10^{-6}$		$+0.5 \times 10^{-6}$	$\pm 4.2 \times 10^{-9}$		
2.	<b>Comb Generator Frequency Accuracy</b> Comb Generator Frequency	Frequency (MHz)					
		99.993		100.007	$\pm 25.0$ Hz		
3.	<b>Frequency Readout Accuracy and Marker Count Accuracy</b> Frequency Readout Accuracy SPAN (MHz)	Frequency (GHz)					
		20		1.50060	$\pm 1$ Hz		
		10		1.50030	$\pm 1$ Hz		
		1		1.500034	$\pm 1$ Hz		
		20		4.00060	$\pm 1$ Hz		
		10		4.00030	$\pm 1$ Hz		
		1		4.000034	$\pm 1$ Hz		
		20		9.00060	$\pm 2$ Hz		
		10		9.00030	$\pm 2$ Hz		
		1		9.000034	$\pm 2$ Hz		
		20		16.00060	$\pm 3$ Hz		
		10		16.00030	$\pm 3$ Hz		
		1		16.000034	$\pm 3$ Hz		
		20		21.00060	$\pm 4$ Hz		
		10		21.00030	$\pm 4$ Hz		
		1		21.000034	$\pm 4$ Hz		
		<b>Marker Count Accuracy</b>					
		CENTER FREQ	SPAN				
		1.5 GHz	20 MHz	1.49999899		1.50000101	$\pm 1$ Hz
		1.5 GHz	1 MHz	1.49999899		1.50000011	$\pm 1$ Hz
4.0 GHz	20 MHz	3.99999899		4.00000101	$\pm 1$ Hz		
4.0 GHz	1 MHz	3.99999899		4.00000011	$\pm 1$ Hz		
9.0 GHz	20 MHz	8.99999899		9.00000101	$\pm 2$ Hz		
9.0 GHz	1 MHz	8.99999899		9.00000011	$\pm 2$ Hz		
16.0 GHz	20 MHz	15.99999899		16.00000101	$\pm 3$ Hz		
16.0 GHz	1 MHz	15.99999899		16.00000011	$\pm 3$ Hz		
21.0 GHz	20 MHz	20.99999899		21.00000101	$\pm 4$ Hz		
21.0 GHz	1 MHz	20.99999899		21.00000011	$\pm 4$ Hz		

**Performance Verification Test Record**

**Performance Verification Test Record (Page 4 of 9)**

Hewlett-Packard Company	Report No. _____
Model HP 8593A	
Serial No. _____	Date _____

Test No.	Test Description	Results			Measurement Uncertainty	
		Min	Measured	Max		
4.	Noise Sidebands Noise Sideband Suppression		_____	-65 dBc	± 1.0 dB	
5.	System Related Sidebands		_____	-65 dBc	± 1.0 dB	
6.	Residual FM		_____	400 Hz	± 45.8 Hz	
7.	Frequency Span Readout Accuracy	_____ MKRΔ Reading (MHz) _____				
		SPAN Setting				
		500 MHz	385.00	_____	415.00	±1.77 MHz
		1000 MHz	770.00	_____	830.00	±3.54 MHz
		2000 MHz	1540.00	_____	1660.00	±7.08 MHz
		100 MHz	77.0	_____	83.0	± 354 kHz
		50 MHz	38.5	_____	41.5	± 177 kHz
		20 MHz	15.40	_____	16.60	±70.8 kHz
		10 MHz	7.80	_____	8.20	±35.4 kHz
		5 MHz	3.900	_____	4.100	±17.7 kHz
		2 MHz	1.560	_____	1.640	±7.08 kHz
		_____ MKRΔ Reading (kHz) _____				
		SPAN Setting				
		1 MHz	780.0	_____	820.0	±3.54 kHz
500 kHz	390.0	_____	410.0	±1.77 kHz		
200 kHz	156.0	_____	164.0	± 708 Hz		
100 kHz	78.0	_____	82.0	± 354 Hz		
8.	Sweep Time Accuracy	_____ MKRΔ Reading _____				
		SWEEP TIME Setting				
		20 ms	15.4 ms	_____	16.6 ms	±0.057 ms
		50 ms	38.5 ms	_____	41.5 ms	±0.141 ms
		100 ms	77.0 ms	_____	83.0 ms	±0.283 ms
		500 ms	385.0 ms	_____	415.0 ms	±1.41 ms
		1 s	770.0 ms	_____	830.0 ms	±2.83 ms
		10 s	7.7 s	_____	8.3 s	±23.8 ms
		50 s	38.5 s	_____	41.5 s	±141.4 ms
		100 s	77.0 s	_____	83.0 s	±283.0 ms



Performance Verification Test Record (Page 5 of 9)

Hewlett-Packard Company	Report No. _____
Model HP 8593A	
Serial No. _____	Date _____

Test No.	Test Description	Results			Measurement Uncertainty
		Min	Measured	Max	
9.	<b>Scale Fidelity</b>				
	Incremental Error				
	dB from Ref Level				
	0	0 (Ref)	0 (Ref)	0 (Ref)	
	-2	-0.2 dB	_____	+0.2 dB	±0.06 dB
	-4	-0.2 dB	_____	+0.2 dB	±0.06 dB
	-6	-0.2 dB	_____	+0.2 dB	±0.06 dB
	-8	-0.2 dB	_____	+0.2 dB	±0.06 dB
	-10	-0.2 dB	_____	+0.2 dB	±0.06 dB
	Log Mode				
	dB from Ref Level				
	0	0 (Ref)	0 (Ref)	0 (Ref)	
	-10	-10.75 dB	_____	-9.25 dB	±0.06 dB
	-20	-20.75 dB	_____	-19.25 dB	±0.06 dB
	-30	-30.75 dB	_____	-29.25 dB	±0.06 dB
	-40	-40.75 dB	_____	-39.25 dB	±0.06 dB
	-50	-50.75 dB	_____	-49.25 dB	±0.06 dB
-60	-60.75 dB	_____	-59.25 dB	±0.11 dB	
-70	-71.00 dB	_____	-69.00 dB	±0.11 dB	
Linear Mode					
% of Ref Level					
100.00	0 (Ref)	0 (Ref)	0 (Ref)		
70.70	150.98 mV	_____	165.20 mV	±1.84 mV	
50.00	104.69 mV	_____	118.91 mV	±1.84 mV	
35.48	72.22 mV	_____	86.44 mV	±1.84 mV	
25.00	48.79 mV	_____	63.01 mV	±1.84 mV	
Log-to-Linear Switching	-0.25 dB	_____	+0.25 dB	±0.05 dB	
10.	<b>Input Attenuator Accuracy</b>				
	Attenuation (dB)				
	10	0 (Ref)	0 (Ref)	0 (Ref)	
	0	-0.5 dB	_____	+0.5 dB	+0.30/-0.31 dB
	20	-0.5 dB	_____	+0.5 dB	+/-0.12 dB
	30	-0.5 dB	_____	+0.5 dB	+/-0.12 dB
	40	-0.5 dB	_____	+0.5 dB	+/-0.12 dB
	50	-0.5 dB	_____	+0.5 dB	+/-0.12 dB
60	-0.5 dB	_____	+0.5 dB	+/-0.12 dB	
70	-1.2 dB	_____	+1.2 dB	+/-0.12 dB	

**Performance Verification Test Record**

**Performance Verification Test Record (Page 6 of 9)**

Hewlett-Packard Company	Report No. _____
Model HP 8593A	
Serial No. _____	Date _____

Test No.	Test Description	Results			Measurement Uncertainty
		Min	Measured	Max	
11.	<b>Reference Level Accuracy</b>				
	Log Mode				
	Reference Level (dBm)				
	-20	0 (Ref)	0 (Ref)	0 (Ref)	
	-10	-0.50 dB	_____	+0.50 dB	±0.06 dB
	0	-0.50 dB	_____	+0.50 dB	±0.06 dB
	-30	-0.50 dB	_____	+0.50 dB	±0.06 dB
	-40	-0.50 dB	_____	+0.50 dB	±0.08 dB
	-50	-0.50 dB	_____	+0.50 dB	±0.08 dB
	-60	-1.25 dB	_____	+1.25 dB	±0.12 dB
	-70	-1.25 dB	_____	+1.25 dB	±0.12 dB
	-80	-1.25 dB	_____	+1.25 dB	±0.12 dB
	-90	-1.25 dB	_____	+1.25 dB	±0.12 dB
		Linear Mode			
		Reference Level (dBm)			
	-20	0 (Ref)	0 (Ref)	0 (Ref)	
	-10	-0.50 dB	_____	+0.50 dB	±0.06 dB
	0	-0.50 dB	_____	+0.50 dB	±0.06 dB
	-30	-0.50 dB	_____	+0.50 dB	±0.06 dB
	-40	-0.50 dB	_____	+0.50 dB	±0.08 dB
-50	-0.50 dB	_____	+0.50 dB	±0.08 dB	
-60	-1.25 dB	_____	+1.25 dB	±0.12 dB	
-70	-1.25 dB	_____	+1.25 dB	±0.12 dB	
-80	-1.25 dB	_____	+1.25 dB	±0.12 dB	
-90	-1.25 dB	_____	+1.25 dB	±0.12 dB	
12.	<b>Resolution Bandwidth</b>				
	<b>Switching Uncertainty</b>				
	RES BW Setting				
	3 kHz	0 (Ref)	0 (Ref)	0 (Ref)	
	1 kHz	-0.5 dB	_____	+0.5 dB	+0.07/-0.08 dB
	10 kHz	-0.4 dB	_____	+0.4 dB	+0.07/-0.08 dB
	30 kHz	-0.4 dB	_____	+0.4 dB	+0.07/-0.08 dB
	100 kHz	-0.4 dB	_____	+0.4 dB	+0.07/-0.08 dB
	300 kHz	-0.4 dB	_____	+0.4 dB	+0.07/-0.08 dB
1 MHz	-0.4 dB	_____	+0.4 dB	+0.07/-0.08 dB	
3 MHz	-0.4 dB	_____	+0.4 dB	+0.07/-0.08 dB	
13.	<b>Calibrator Amplitude Accuracy</b>	-20.4 dBm	_____	-19.6 dBm	± 0.2 dB

Performance Verification Test Record (Page 7 of 9)

Hewlett-Packard Company	
Model HP 8593A	Report No. _____
Serial No. _____	Date _____

Test No.	Test Description	Results		Measurement Uncertainty
		Min	Measured	
14.	<b>Frequency Response</b>			
	Band 0			
	Max Positive Response			+1.5 dB
	Max Negative Response	-1.5 dB		
	Peak-to-Peak Response			2.0 dB
	Band 1			
	Preselector Peaked:			
	Max Positive Response			+2.0 dB
	Max Negative Response	-2.0 dB		
	Peak-to-Peak Response			3.0 dB
	Preselector Unpeaked:			
	Max Positive Response			+3.0 dB
	Max Negative Response	-3.0 dB		
	Band 2			
	Preselector Peaked:			
	Max Positive Response			+2.5 dB
	Max Negative Response	-2.5 dB		
	Peak-to-Peak Response			4.0 dB
	Preselector Unpeaked:			
	Max Positive Response			+3.0 dB
	Max Negative Response	-3.0 dB		
Band 3				
Preselector Peaked:				
Max Positive Response			+3.0 dB	
Max Negative Response	-3.0 dB			
Peak-to-Peak Response			4.0 dB	
Preselector Unpeaked:				
Max Positive Response			+4.0 dB	
Max Negative Response	-4.0 dB			

**Performance Verification Test Record**

**Performance Verification Test Record (Page 8 of 9)**

Hewlett-Packard Company	Report No. _____
Model HP 8593A	
Serial No. _____	Date _____

Test No.	Test Description	Results			Measurement Uncertainty
		Min	Measured	Max	
14.	<b>Frequency Response (cont'd)</b>				
	<b>Band 4 (non-Option 026)</b>				
	<b>Preselector Peaked:</b>				
	Max Positive Response		_____	+3.0 dB	+0.54/-0.57 dB
	Max Negative Response	-3.0 dB	_____		+0.54/-0.57 dB
	Peak-to-Peak Response		_____	4.0 dB	+0.54/-0.57 dB
	<b>Preselector Unpeaked:</b>				
	Max Positive Response		_____	+4.0 dB	+0.54/-0.57 dB
	Max Negative Response	-4.0 dB	_____		+0.54/-0.57 dB
	<b>Band 4, Option 026</b>				
<b>Preselector Peaked:</b>					
Max Positive Response		_____	+5.0 dB	+0.54/-0.57 dB	
Max Negative Response	-5.0 dB	_____		+0.54/-0.57 dB	
Peak-to-Peak Response		_____	4.0 dB	+0.54/-0.57 dB	
<b>Preselector Unpeaked:</b>					
Max Positive Response		_____	+5.0 dB	+0.54/-0.57 dB	
Max Negative Response	-5.0 dB	_____		+0.54/-0.57 dB	
15.	<b>Other Input Related</b>				
	<b>Spurious Responses</b>				
	50 kHz to 2.9 GHz		_____	-60 dBc	+1.12/-1.21 dB
	≤18 GHz		_____	-60 dBc	+1.13/-1.22 dB
≤22 GHz		_____	-50 dBc	+1.15/-1.25 dB	
16.	<b>Spurious Responses</b>				
	<b>Second Harmonic Distortion</b>				
	<b>Applied Frequency</b>				
	40 MHz		_____	-50 dBc	+1.86/-2.27 dB
	2.8 GHz		_____		+2.24/-2.72 dB
	<b>from Step 20c</b>				
<b>Third Order Intermodulation Distortion</b>					
<b>Frequency</b>					
2.80 GHz		_____	-54 dBc	+2.07/-2.42 dB	
4.00 GHz		_____	-54 dBc	+2.07/-2.42 dB	

Performance Verification Test Record (Page 9 of 9)

Hewlett-Packard Company	Report No. _____
Model HP 8593A	
Serial No. _____	Date _____

Test No.	Test Description	Results			Measurement Uncertainty
		Min	Measured	Max	
17.	<b>Gain Compression</b>				
	Band 0			0.5 dB	+0.21/-0.22 dB
	Band 1			0.5 dB	+0.21/-0.22 dB
18.	<b>Displayed Average Noise Level</b>				
	Frequency				
	400 kHz			-112 dBm	+1.15/-1.25 dB
	1 MHz			-112 dBm	+1.15/-1.25 dB
	1 MHz to 2.9 GHz			-112 dBm	+1.15/-1.25 dB
	2.75 GHz to 6.4 GHz			-114 dBm	+1.15/-1.25 dB
	6.0 GHz to 12.8 GHz			-102 dBm	+1.15/-1.25 dB
	12.4 GHz to 19.4 GHz			-98 dBm	+1.15/-1.25 dB
	19.1 GHz to 22 GHz			-92 dBm	+1.15/-1.25 dB
19.1 GHz to 26.5 GHz (Option 026)			-87 dBm	+1.15/-1.25 dB	
19.	<b>Residual Responses</b>				
	Band 0			-90 dBm	+1.09/-1.15 dB
	Band 1			-90 dBm	+1.09/-1.15 dB
20.	<b>10 MHz Reference Output Accuracy (Option 004)</b>				
	5 Minute Warmup Error	$-1 \times 10^{-7}$		$+1 \times 10^{-7}$	$\pm 2.004 \times 10^{-9}$
	30 Minute Warmup Error	$-1 \times 10^{-8}$		$+1 \times 10^{-8}$	$\pm 2.002 \times 10^{-9}$
21.	<b>Fast Time Domain Sweeps (Option 101)</b>				
	Amplitude Accuracy	0.933X		1.007X	0%
	SWEEP TIME Setting				
	18 ms	14.04 ms		14.76 ms	$\pm 0.5\%$
	10 ms	7.80 ms		8.20 ms	$\pm 0.5\%$
	5 ms	3.90 ms		4.10 ms	$\pm 0.5\%$
	2 ms	1.56 ms		1.64 ms	$\pm 0.5\%$
	1.0 ms	780 $\mu$ s		820 $\mu$ s	$\pm 0.5\%$
	500 $\mu$ s	390 $\mu$ s		410 $\mu$ s	$\pm 0.5\%$
	200 $\mu$ s	156 $\mu$ s		164 $\mu$ s	$\pm 0.5\%$
	100 $\mu$ s	78 $\mu$ s		82 $\mu$ s	$\pm 0.5\%$
	60 $\mu$ s	46.8 $\mu$ s		49.2 $\mu$ s	$\pm 0.5\%$
	40 $\mu$ s	31.2 $\mu$ s		32.8 $\mu$ s	$\pm 0.5\%$
20 $\mu$ s	15.6 $\mu$ s		16.4 $\mu$ s	$\pm 0.5\%$	



## Operation

---

### What You'll Learn in this Chapter

This chapter introduces the basic functions of the spectrum analyzer. In this chapter you will:

- Get acquainted with the front-panel and rear-panel features.
- Get acquainted with the menus and softkeys.
- Measure a signal (the calibration signal).
- Learn screen annotation.
- Improve measurement accuracy using self-calibration routines.
- Save and recall data from analyzer memory.
- Save and recall data from the memory card.
- Learn about creating limit-line(s).
- Learn about entering amplitude correction factors.
- Learn how to change the power-on state of the analyzer.
- Use the external keyboard (Option 021 or 023 only).

---

#### Note



Before using your analyzer, please read Chapter 2, "Installation and Preparation for Use," which describes how to install your analyzer and how to verify that it is operational. It describes many safety considerations that should not be overlooked.

---

---

## Getting Acquainted with the Analyzer

### Front-Panel Feature Overview

The following section provides a brief description of front-panel features. Refer to Figure 5-1.

1. **Active function block** is the space on the screen that indicates the active function. Most functions appearing in this block can be changed with the knob, step keys, or number/units keypad.
2. **Message block** is the space on the screen where MEAS UNCAL and the asterisk (\*) appear. If one or more functions are manually set (uncoupled), and the amplitude or frequency becomes uncalibrated, MEAS UNCAL appears. (Use **AUTO COUPLE**, AUTO ALL to recouple functions.) The asterisk indicates that a function is in progress.

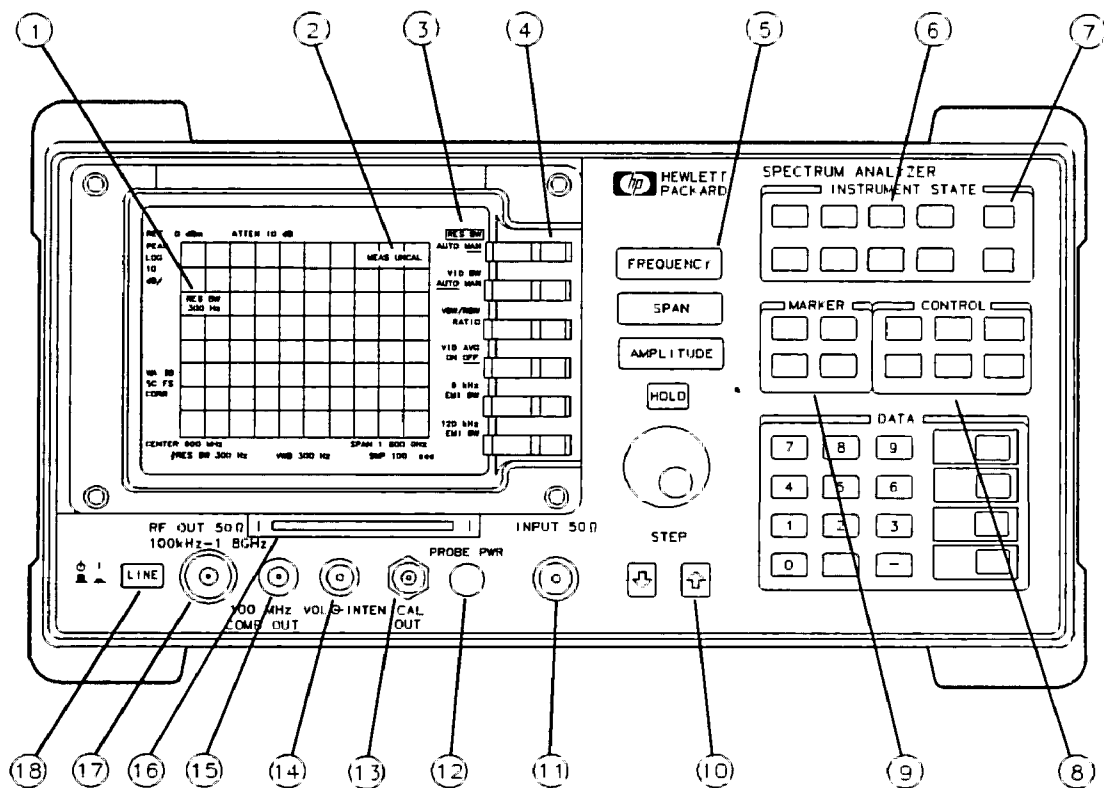

**Figure 5-1. Front-Panel Feature Overview**

3. **Softkey labels** are the annotation on the screen next to the unlabeled keys. Most of the labeled keys on the analyzer's front panel (also called front-panel keys) access menus of related softkeys.
  4. **Softkeys** are the unlabeled keys next to the screen.
  5. **FREQUENCY**, **SPAN**, and **AMPLITUDE** are the three large dark-gray keys that activate the primary analyzer functions and access menus of related functions.
  6. **INSTRUMENT STATE** functions affect the state of the entire spectrum analyzer. Self-calibration routines and special-function menus are accessed with these keys. The green **PRESET** key resets the entire analyzer state and can be used as a "panic" button when you wish to return to a known state. The **MODE** key accesses the current operating mode of the analyzer and allows you to change to any operating mode available for your analyzer. All analyzers have the spectrum analyzer mode of operation (indicated by **SPECTRUM ANALYZER**). If an additional softkey label appears in the softkey label area, a program (also called a downloadable program or personality) has been loaded into the analyzer's memory. This manual covers the spectrum analyzer mode of operation only; consult the documentation accompanying the HP 85711A Cable Television Measurements Card, the HP 85712A EMI Diagnostics Measurements Card, or the HP 85713A Digital Radio Measurements Card for other modes of operation.
- SAVE** and **RECALL** save and recall traces, states, limit-line tables, amplitude correction factors, and programs to or from a memory card. **SAVE** and **RECALL** also save and recall



traces, states, limit-line tables, and amplitude correction factors to or from the analyzer memory.

---

**Note**

If you wish to reset the analyzer configuration to the state it was in when it was originally shipped from the factory, use **DEFAULT CONFIG**. See “DEFAULT CONFIG” in Chapter 7 for information.

---

7. **COPY** key prints or plots screen data. (This requires Option 021 or 023.) Use **CONFIG**, **PLOT CONFIG** or **PRINT CONFIG**, and **COPY DEV PRNT PLT** before using the **COPY** function.
  8. **CONTROL** functions access menus that allow you to adjust the resolution bandwidth, adjust the sweep time, store and manipulate trace data, and control the instrument display.
  9. **MARKER** functions control the markers, read out frequencies and amplitudes along the spectrum-analyzer trace, automatically locate the signals of highest amplitude, and keep a signal at the marker position in the center of the screen.
  10. **DATA** keys, **STEP** keys, and **knob** allow you to change the numeric value of an active function. **HOLD** deactivates an active function.
  11. **INPUT 50Ω** is the signal input for the spectrum analyzer. (**INPUT 75Ω** is the signal input for an Option 001 analyzer.)
- 

**Caution**

Excessive signal input will damage the analyzer input attenuator and the input mixer. The maximum power that the spectrum analyzer can tolerate appears on the front panel.

---

12. **PROBE PWR** provides the power for an active probe and other accessories.
  13. **CAL OUT** provides a calibration signal of 300 MHz at -20 dBm (29 dBmV for Option 001 or 011) on the front panel.
  14. **VOL-INTEN** changes the brightness of the screen display and the volume of the speaker (the speaker is available with Option 102).
  15. **100 MHz COMB OUT** supplies a 100 MHz signal with harmonics up to 22 GHz for use as a reference signal (for the HP 8593A only).
  16. **Memory card reader** reads from or writes to a memory card.
- 

**Caution**

The tracking generator output may damage the device under test. Do not exceed the maximum power that the device under test can tolerate.

---

17. **RF OUT 50Ω** supplies 100 kHz to 1.8 GHz at the output for the built-in tracking generator (available with Option 010 for the HP 8591A only). (**RF OUT 75Ω** is the tracking generator output for Option 011 and it supplies 1 MHz to 1.8 GHz source output.)
18. **LINE** turns the instrument on or off and performs an instrument check.

## Rear-Panel Features

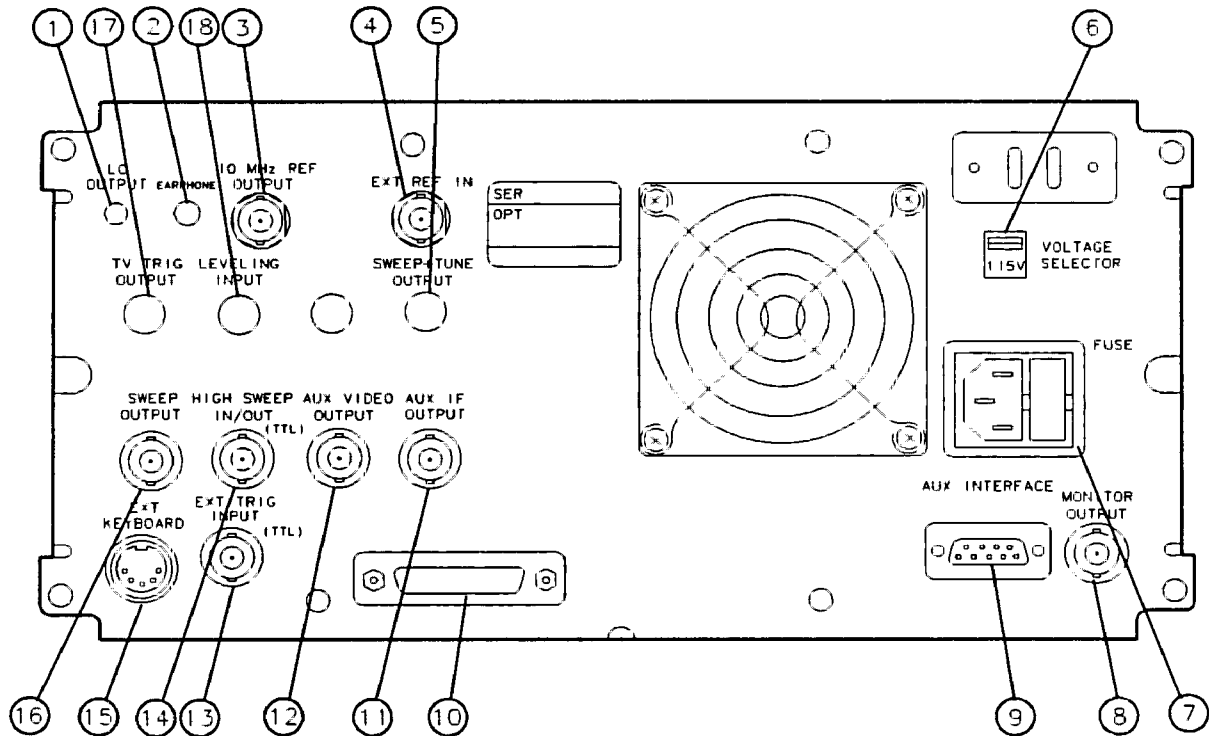

**Figure 5-2. HP 8591A / HP 8593A Rear-Panel Overview**

1. **LO OUTPUT** is not available.
2. **EARPHONE** connector provides a connection for an earphone jack instead of using the internal speaker. (Option 102 only.)
3. **10 MHz REF OUTPUT** provides a 10 MHz, 0 dBm minimum, time-based reference signal.
4. **EXT REF IN** accepts an external frequency source to provide the 10 MHz, -2 to +10 dBm frequency reference used by the analyzer.
5. **SWEEP + TUNE OUTPUT** is not available.
6. **VOLTAGE SELECTOR** adapts the unit to the power source: 115 V or 230 V.
7. **Power input** is the input for the main power cable. Insert the main-power cable plug only into a socket outlet that has a protective ground contact.
8. **MONITOR OUTPUT** drives an external CRT monitor, such as the HP 82913A, with a 19.2 kHz horizontal synchronizing rate.

---

**Caution**

Turn off the analyzer before connecting the AUX INTERFACE connector to a device. Failure to do so may result in loss of factory correction constants.

Do not exceed the +5 V supply current limits when using the AUX INTERFACE connector. Exceeding the current limits may result in loss of factory correction constants.

Do not use the AUX INTERFACE as a video monitor interface. Damage to the video monitor will result.

---

9. **AUX INTERFACE** provides a nine-pin "D" subminiature connector for control of external devices. See Table 1-2 or Table 1-4 for a detailed description.
  10. **Interface connectors** are optional interfaces for HP-IB and RS-232 interface buses that support remote instrument operation and direct plotting or printing of screen data.
  11. **AUX IF OUTPUT** is a 50 $\Omega$ , 21.4 MHz IF output that is the down-converted signal of the RF input of the analyzer.
  12. **AUX VIDEO OUTPUT** provides detected video output (before the analog-to-digital conversion) proportional to vertical deflection of the CRT trace. Output is from 0 V to 1 V. Amplitude correction factors are not applied to this signal.
  13. **EXT TRIG INPUT (TTL)** triggers the analyzer's internal sweep source using the positive edge of an external voltage.
  14. **HI SWEEP IN/OUT (TTL)** indicates sweep or can be grounded to stop sweep.
- 

**Caution**

Turn off the analyzer before connecting an external keyboard to the analyzer.

---

15. **EXT KEYBOARD** connector is provided with the optional interface connector. The external keyboard is not included with the analyzer. The external keyboard allows screen titles, prefixes, and remote commands to be entered using an external keyboard.
16. **SWEEP OUTPUT** provides a voltage ramp proportional to the sweep and the analyzer span (0 V to 10 V).
17. **TV TRIG OUTPUT (TTL)** provides TV trigger output using TTL and negative edge triggering. (Options 101 and 102 only.)
18. **LEVELING INPUT** allows the use of an external detector or power meter for automatic leveling control of the tracking generator. (HP 8591A Option 010 or 011 only.)

---

## Menu and Softkey Overview

The keys labeled **FREQUENCY**, **CAL**, and **MKR** are all examples of front-panel keys. Pressing most front-panel keys accesses menus which are displayed along the right side of the display. These menus are called softkey menus. These menus list functions other than those accessed directly by the front-panel keys. To activate a function on the menu, press the unlabeled keys immediately to the right of the annotation on the screen. The unlabeled keys next to the annotation on the display screen are called softkeys. In this manual, front-panel keys appear in boldface type within a box, for example, **AMPLITUDE**. Softkeys appear within a shaded box, for example, **REF LEVEL**.

A softkey function's value can be changed; it is called an active function. The function label of the active function appears in inverse video. For example, press **AMPLITUDE**. The active function, **REF LVL**, appears in inverse video and **REF LVL** is displayed in the active function block of the on-screen display.

A softkey with **ON** and **OFF** in its label can turn the softkey function on or off. To turn the function on, press the softkey so that **ON** is underlined. To turn the function off, press the softkey so that **OFF** is underlined.

A function with **AUTO** and **MAN** in the label can be auto-coupled or have its value manually changed. The function's value can be changed manually by activating the function with a key press, and changing its value with the numeric keypad, knob, or step keys. To auto-couple a function that had been changed manually, press the softkey so that **AUTO** is underlined.

To select another menu, press another labeled front-panel key, or choose a softkey such as **MORE 1 of 2**.

A summary of all softkeys can be found at the end of this manual.

---

## Making a Measurement

### Caution



Do not exceed the maximum input power. The maximum input power is +30 dBm (1 watt) continuous, 25 V dc with  $\geq 10$  dB attenuation for the HP 8591A. The maximum input power is +30 dBm (1 watt) continuous, 0 V dc. Use input attenuation  $\geq 10$  dB in bands 1 through 4 for the HP 8593A.

---

Let's begin using the spectrum analyzer by measuring an input signal. Since the 300 MHz calibration signal (**CAL OUT**) is readily available, we will use it as our input signal.

First, turn the instrument on by pressing **LINE**. Wait for the power-up process to complete.

Press the green **PRESET** key. Connect **CAL OUT** to the analyzer input using an appropriate cable, then follow the steps below.

#### ■ Relax!

You cannot hurt the analyzer by using the calibration signal and pressing any of the keys described in this section. Don't be afraid to play with the knob, step keys, or number/units keypad. (If you have experimented with other keys and wish to return to a known state, press the green **PRESET** key.)

■ **Set the frequency.**

Press the **FREQUENCY** key. **CENTER** appears on the left side of the screen, indicating that the center-frequency function is active. The **CENTER FREQ** softkey label appears in inverse video to indicate that center frequency is the active function. The active function block is the space on the screen within the graticule where the center frequency messages appear. Functions appearing in this block are active: their values can be changed with the knob, step keys, or number/units keypad. Set the center frequency to 300 MHz with the **DATA** keys by pressing 300 **MHz**. The knob and step keys can also be used to set the center frequency.

■ **Set the span.**

Press **SPAN**. **SPAN** is now displayed in the active function block, and the **SPAN** softkey label appears in inverse video to indicate it is the active function. Reduce the span to 2 MHz by using the knob, by pressing the down key (**▼**), or pressing 2 **MHz**.

■ **Set the amplitude.**

When the peak of a signal does not appear on the screen, it may be necessary to adjust the amplitude level on the screen. Press **AMPLITUDE**. **REF LEVEL .0 dBm** appears in the active function block. The **REF LVL** level softkey label appears in inverse video to indicate it is the active function. The reference level is the top graticule line on the display and is set to 0.0 dBm. Changing the value of the reference level changes the amplitude level of the top graticule line.

If desired, use the reference level function to place the signal peak on the screen using the knob, step keys, or number/units keypad. (Markers, described earlier, determine the frequency and amplitude of a signal.)

Figure 5-3 demonstrates the relationship between center frequency and reference level. The box in the figure represents the spectrum analyzer screen. Changing the center frequency changes the horizontal placement of the screen. Changing the reference level changes the vertical placement of the screen. Increasing the span increases the frequency range that appears horizontally on the screen.

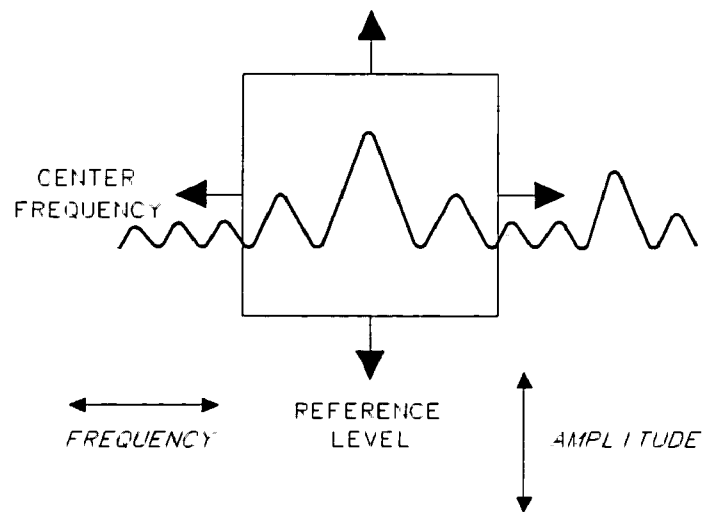

**Figure 5-3. Relationship between Frequency and Amplitude**

■ **Marker**

You can place a diamond-shaped marker on the signal peak to find the signal's frequency and amplitude.

To activate a marker, press the **MKR** key (located in the MARKER section of the front panel). The **MARKER NORMAL** label appears in inverse video to show it is the active function. Turn the knob to place the marker at the signal peak.

You can also use the **PEAK SEARCH** key, which automatically places a marker at the highest point on the trace.

Readouts of marker amplitude and frequency appear in the active function block and in the upper-right corner of the display. Look at the marker readout to determine the amplitude of the signal.

If another function is activated, the frequency and amplitude can still be found from the marker readout in the upper-right corner of the screen.

## Measurement Summary

1. Connect CAL OUT to the analyzer input, and press the green **PRESET** key.
2. Set the center frequency: **FREQUENCY** 300 **MHz**.
3. Set the span: **SPAN** 2 **MHz**.
4. The calibration signal is 20 dB (two graticule divisions) below the top of the screen in these settings. If desired, adjust the reference level: press **AMPLITUDE** to activate the reference level and use the knob or step keys to change the reference level.
5. Determine the amplitude and frequency of the signal. You can either press **PEAK SEARCH** or press **MKR** and move the marker to the signal peak. Read the amplitude and frequency. The display screen should look like the one in Figure 5-4. Frequency is displayed horizontally, and amplitude (power) is displayed vertically.

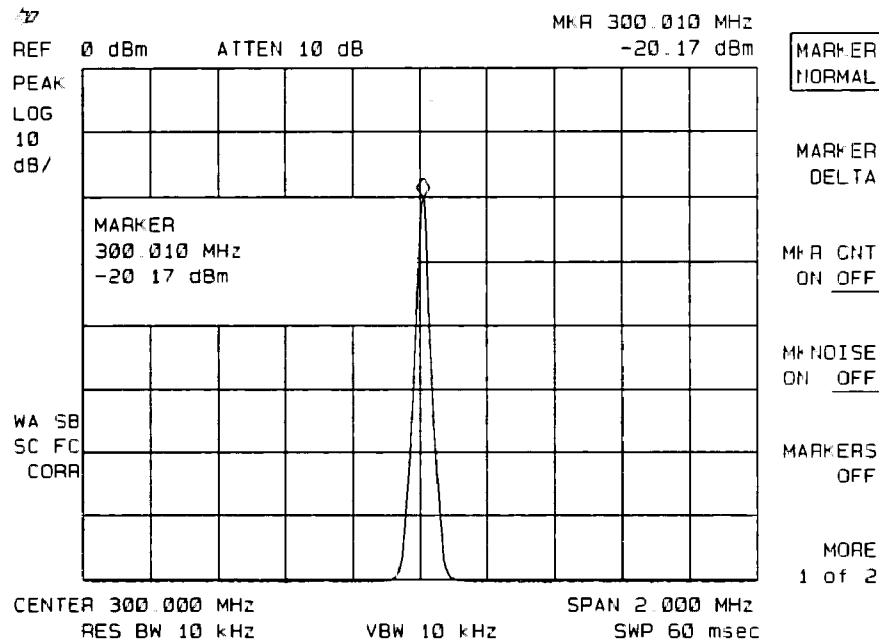

**Figure 5-4. Reading the Amplitude and Frequency**

### Note

HP 8591A analyzers with Option 001 display the amplitude values in dBmV.



## Screen Annotation

Figure 5-5 shows annotation as it appears on the screen of the analyzer. Table 5-1 lists the features of the front panel annotation numerically and refers to the annotation in Figure 5-5. The function key column indicates which front-panel key or softkey activates the screen annotation. See Chapter 7 for more information on a specific function key.

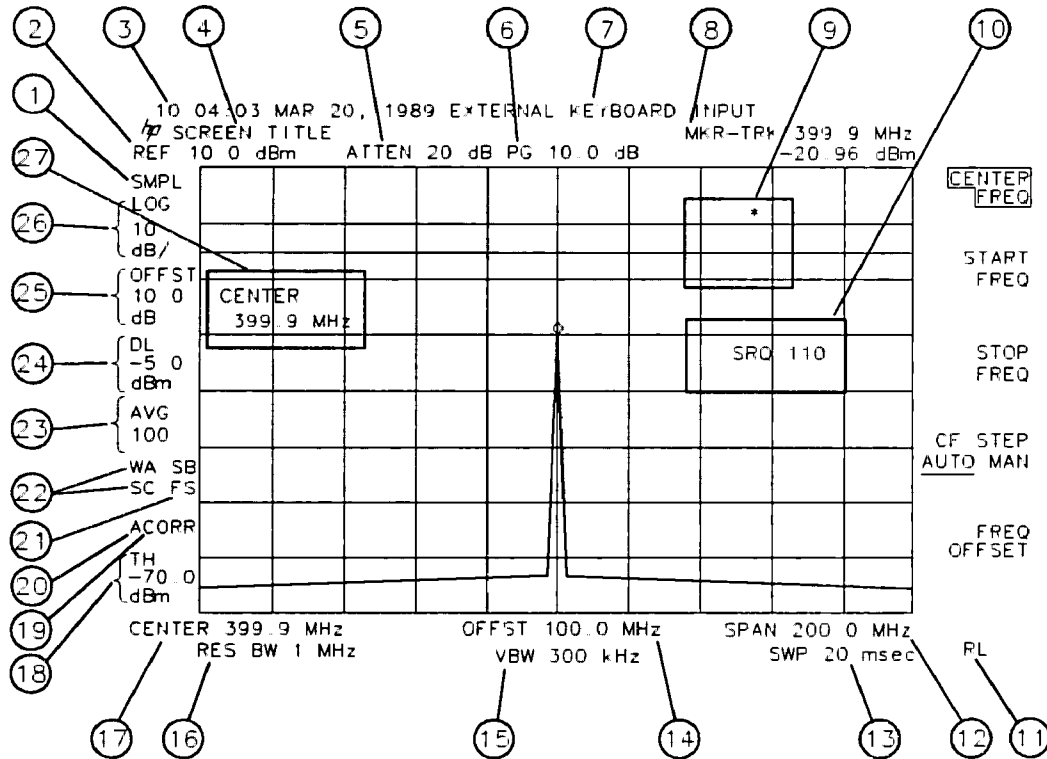

**Figure 5-5. Screen Annotation**

In Figure 5-5, index number 21 refers to the trigger and sweep modes of the analyzer. The first letter (“F”) indicates the analyzer is in free-run trigger mode. The second letter (“S”) indicates the analyzer is in single-sweep mode.

Index number 22 refers to the trace modes of the analyzer. The first letter (“W”) indicates the analyzer is in clear-write mode. The second letter is “A,” representing trace A. The next two letters (“SB”) indicate the store-blank mode (“S”) for trace B (“B”). The trace mode annotation for trace C is displayed under the trace mode annotation of trace A. In Figure 5-5, the trace C trace mode is “SC”, indicating trace C (“C”) is in the store blank mode (“S”).

Table 5-2 shows the different screen annotation codes for trace, trigger, and sweep modes.



**Table 5-1. Screen Annotation**

Index Number	Description	Function Key
1	detector mode	DETECTOR SAMPL PK
2	reference level	REF LVL
3	time/date display	TIMEDATE ON OFF
4	screen title	CHANGE TITLE
5	RF attenuation	ATTEN AUTO MAN
6	preamplifier gain	EXT PREAMP
7	external keyboard entry	See "EXT KEYBOARD" in Chapter 7
8	marker/signal track readout	(MKR), (MKR ->), (SIGNAL TRACK), or (PEAK SEARCH)
9	measurement uncalibrated/function-in-progress messages	(AUTO COUPLE)
10	service request	See Appendix B
11	remote operation	See "(LOCAL)" in Chapter 7
12	frequency span or stop frequency	(SPAN), STOP FREQ
13	sweep time	SWP TIME AUTO MAN
14	frequency offset	FREQ OFFSET
15	video bandwidth	VID BW AUTO MAN
16	resolution bandwidth	RES BW AUTO MAN
17	center frequency or start frequency	CENTER FREQ, START FREQ
18	threshold	THRESHLD ON OFF
19	correction factors on	CORRECT ON OFF
20	amplitude correction factors on	See "Entering Amplitude Correction Factors" in this Chapter.
21	trigger	(TRIG)
22	trace mode	(TRACE)
23	video average	VID AVG ON OFF
24	display line	DSP LINE ON OFF
25	amplitude offset	REF LVL OFFSET
26	amplitude scale	SCALE LOG LIN
27	active function block	Refer to the softkey function that was activated

**Table 5-2. Screen Annotation for Trace, Trigger, and Sweep Modes**

Trace Mode	Trigger Mode	Sweep Mode
W = clear write (traces A/B/C)	F = free run	C = continuous
M = maximum hold (traces A/B)	L = line	S = single sweep
V = view (traces A/B/C)	V = video	
S = store blank (traces A/B/C)	E = external	
M = minimum hold (trace C)	T = TV (Options 101 and 102 only)	

---

## Improving Accuracy with Self-Calibration Routines

Self-calibration routines improve the analyzer's frequency and amplitude accuracy. Press the **CAL** key to view the self-calibration routine menus. The last function on this menu, labeled **MORE 1 of 3**, provides access to additional self-calibration functions. For a summary of all self-calibration softkeys, see Chapter 7.

The self-calibration routines add correction factors to internal circuitry. The addition of the correction factors is required to meet frequency and amplitude specifications.

When the correction factors are added to internal circuitry, **CORR (corrected)** appears on the left side of the screen.

### Warm-Up Time

To meet spectrum analyzer specifications, allow the analyzer to warm up for 30 minutes after being turned on before attempting to make any calibrated measurements. Be sure to calibrate the analyzer only *after* the analyzer has met operating temperature conditions.

The spectrum analyzer frequency and amplitude self-calibration routines are initiated by the **CAL FREQ & AMPTD** softkey in the **CAL** menu.

1. To calibrate the instrument, connect **CAL OUT** to the analyzer input connector, using an appropriate cable.

---

#### Note



A low-loss cable should be used for accurate calibration. Use the 50Ω cable shipped with the analyzer (*Option 001 or 011*: use the 75Ω cable shipped with the analyzer).

2. Press the following analyzer keys: **CAL**, **CAL FREQ & AMPTD**. **CAL SIGNAL NOT FOUND** will be displayed if **CAL OUT** is not connected to the analyzer input. The frequency and reference-level self-calibration functions take approximately 9 minutes to finish, at which time the internal adjustment data is in working RAM.
3. To save this data in the area of analyzer memory that is saved when the analyzer is turned off, press **CAL STORE**.

---

#### Note



To interrupt **CAL FREQ**, **CAL AMPTD**, or **CAL FREQ & AMPTD**, press **PRESET**, **CAL**, **CAL FETCH**. **CAL FETCH** retrieves the previous correction factors. Improperly interrupting the self-calibration routines may result in corrupt correction factors. (If this occurs, rerun the **CAL FREQ & AMPTD** routine.)

---

The frequency and amplitude self-calibration functions can be done separately by using the **CAL FREQ** or **CAL AMPTD** softkeys instead of the **CAL FREQ & AMPTD**.

---

#### Note



If **CAL FREQ** and **CAL AMPTD** self-calibration routines are used, **CAL FREQ** should be performed before **CAL AMPTD**, unless the frequency data is known to be accurate.

---

The **CAL FREQ** softkey starts the frequency self-calibration routine. This routine adjusts the frequency, sweep time, and span accuracy in approximately 2 minutes.

The **CAL AMPTD** softkey starts the amplitude calibration routine. This routine takes approximately 7 minutes to adjust the bandwidths, log/linear switching, IF gains, IF frequency centering, RF attenuation, and log amplifier. When the amplitude calibration routine has finished, the preset display returns and **CAL DONE** is displayed.

Although the analyzer stores the correction factors in battery-backed RAM, the data will not be saved if the analyzer power is turned off unless the data has been stored with **CAL STORE**. Using **CAL STORE** stores the correction factors in an area of analyzer memory that is accessed when the analyzer is turned on.

**CORR** (corrected) now appears on the left side of the screen, indicating that the analyzer is using its frequency and amplitude correction factors. Correction factors can be turned off by pressing **CORRECT ON OFF**. When **OFF** is underlined, most amplitude correction factors and some frequency correction factors are not used.

If the self-calibration routines cannot be performed, see “Problems” in Chapter 8.

### Performing the Tracking Generator Self-Calibration Routine (Option 010 or 011 only)

To meet the tracking generator specifications, allow the analyzer to warm up for 30 minutes after being turned on before attempting to make any calibrated measurements. Be sure to calibrate the analyzer and the tracking generator only *after* the analyzer has met operating temperature conditions.

---

#### Note



Since the **CAL TRK GEN** routine uses the absolute amplitude level of the analyzer, the analyzer amplitude should be calibrated prior to using **CAL TRK GEN**.

---

1. To calibrate the tracking generator, connect the tracking generator output (RF OUT 50 $\Omega$ ) to the analyzer input connector, using an appropriate cable and adapters.

---

#### Note



A low-loss cable should be used for accurate calibration. Use the 50 $\Omega$  cable shipped with the analyzer (*Option 011*: use the 75 $\Omega$  cable shipped with the analyzer).

---

2. Press the following analyzer keys: **CAL**, **MORE 1 of 3**, **MORE 2 of 3**, **CAL TRK GEN**. **TG SIGNAL NOT FOUND** will be displayed if the tracking generator output is not connected to the analyzer input.
3. To save this data in the area of analyzer memory that is saved when the analyzer is turned off, press **CAL STORE**.

## Performing the YTF Self-Calibration Routine (HP 8593A Only)

For HP 8593A analyzers only, the **CAL YTF** self-calibration routine should be performed periodically. See "When Is Self-Calibration Needed?" in this chapter for some helpful guidelines on how often the self-calibration routines should be performed.

1. Connect a low-loss cable (such as HP part number 8120-5148) from 100 MHz COMB OUT to the analyzer input.
2. Press **CAL**, **CAL YTF**. The YTF self-calibration routine completes in approximately 4 minutes.
3. Press **CAL**, **CAL STORE**.

## When Is Self-Calibration Needed?

While it is difficult to provide general advice for your specific measurement needs, the following suggestions may help you decide when to use the self-calibration features:

1. Perform **CAL FREQ & AMPTD** whenever the instrument experiences significant environmental changes such as temperature ( $\pm 5^{\circ}\text{C}$ ), humidity, shock, or vibration (for example, shipping or transport). This is especially important if **CAL FREQ & AMPTD** was performed last in a different environment.
2. If the environment is relatively stable (for example, a lab environment), use **CAL FREQ & AMPTD** monthly. After being turned off overnight, the analyzer will need to warm up, but should not require self-calibration.
3. To achieve optimal amplitude accuracy for relative measurements:
  - a. Keep the analyzer in a stable environment.
  - b. Use **CAL FREQ & AMPTD** before beginning the first measurement.
  - c. Keep the analyzer turned on between measurements.
  - d. Do not use **CAL FREQ & AMPTD** before subsequent measurements (the amplitude drift is normally smaller than the self-calibration uncertainty).
4. If you change the input signal for **EXT REF IN**, run **CAL FREQ & AMPTD** using **CAL OUT**. **CAL AMPTD** is required to improve IF centering.
5. If **PRESEL PEAK** has more than a 2 dB effect on signal amplitude when in **BAND 1** or above and in a single band sweep, perform **CAL YTF** with the **COMB OUT** signal, and store the data with **CAL STORE**. **CAL YTF** improves the **PRESEL DEFAULT** values. (HP 8593A only.)
6. If accurate self-calibration is needed temporarily in a different environment, use **CAL FREQ & AMPTD** but do not press **CAL STORE**. The temporary correction factors will be used until the analyzer is turned off or until **CAL FETCH** is pressed.

---

## Saving and Recalling Data from Analyzer Memory

This section explains how to save and recall state, trace, limit line, and amplitude correction factor data to and from analyzer memory.

Analyzer memory can store up to eight states using `STATE -> INTRNL`, and it can store many traces, limit-line tables, and amplitude correction factors using `TRACE -> INTRNL`.

Saving state data saves the analyzer settings (but not the trace data). Saving trace data saves the trace data and the state data. Limit-line data and amplitude correction factors are stored in trace registers, but state and trace data are not recalled with the limit-line data or the amplitude correction factors. States, traces, limit-line tables, and amplitude correction factors are saved in analyzer memory even if the instrument is turned off or **PRESET** is pressed.

See Chapter 7, "CATALOG INTRNL," for information about cataloging analyzer memory.

### To Save a State

1. Set up the analyzer settings to be saved.
2. Press **SAVE**. Press `INTRNL CRD` to select INTRNL if CRD is underlined. Selecting INTRNL selects the analyzer memory as the mass storage device.
3. Press `STATE -> INTRNL`. `SAVE: REG` is displayed on the analyzer display.
4. Enter a number from one to eight using the numeric keypad. There is no need to press **ENTER**; the state is saved automatically.

### To Recall a State

1. Press **RECALL**. Press `INTRNL CRD` to select INTRNL if CRD is underlined.
2. Press `CATALOG INTRNL`, `CATALOG REGISTERS`. Use the knob to highlight the state register number to be retrieved. The state registers have a "ST" preceding the register number.
3. Press `LOAD FILE`.

State data can also be recalled by specifying the register number:

1. Press **RECALL**. Press `INTRNL CRD` to select INTRNL if CRD is underlined.
2. Press `INTRNL -> STATE`.
3. Enter the register number under which the state was saved. There is no need to press **ENTER**; the state is recalled automatically.

---

### Note



Register 9 is a special register which can aid in recovering from inadvertent loss of line power (power failure). Press **RECALL**, `INTRNL -> STATE 9` to place the analyzer in the state that existed just prior to the loss of power.

---

## To Save a Trace

Saving trace data is very similar to saving state data. Saving trace data saves the trace data and the state data.

1. Enter a screen title using **DISPLAY**, **CHANGE TITLE**, if desired.
2. Set up the trace to be stored.
3. Press **SAVE**. Press **INTRNL CRD** to select INTRNL if CRD is underlined.
4. Press **TRACE -> INTRNL**. This accesses a menu displaying **TRACE A**, **TRACE B**, and **TRACE C**.
5. Press the softkey label of the trace that you want to save: **TRACE A**, **TRACE B**, or **TRACE C**. **REGISTER #** and **MAX REG # =** are displayed on the analyzer display. The number after **MAX REG # =** indicates the maximum register number that can be entered for trace storage in analyzer memory.
6. Enter a number from 0 to the maximum register number using the numeric keypad and press **ENTER**.

## To Recall a Trace

1. Press **RECALL**. Press **INTRNL CRD** to select INTRNL if CRD is underlined.
2. Press **CATALOG INTRNL**, **CATALOG REGISTER**. Use the knob to highlight the trace register number to be retrieved. The trace registers have a "TR" preceding the trace register number.
3. Press **LOAD FILE**. The recalled trace is placed into trace B and the analyzer state is changed to the state that was saved.

Trace data can also be recalled by specifying the register number:

1. Press **RECALL**. Press **INTRNL CRD** to select INTRNL if CRD is underlined.
2. Press **INTRNL ->TRACE**. **INTRNL ->TRACE** accesses a menu displaying **TRACE A**, **TRACE B**, **TRACE C**, **LIMIT LINES**, and **AMPLTUD COR FACT**.
3. Select the trace in which you want to place the trace data by pressing **TRACE A**, **TRACE B**, or **TRACE C**.
4. Enter the register number under which the trace was stored.
5. Press **ENTER**. The recalled trace is placed in the view mode and the analyzer state is changed to the state that was saved.

## To Save a Limit-Line Table or Amplitude Correction Factors

The procedure for saving limit-line tables or amplitude correction factors is similar to saving trace data. State and trace data is not recalled with limit-line tables or amplitude correction factors.

---

### Note



**SAVE LIMIT** and **RECALL LIMIT** provide an easy way to save and recall limit-lines from the current mass storage device (analyzer memory or the memory card). See “Using Limit-Line Functions” later in this chapter for more information.

---

1. Enter a screen title using **DISPLAY**, **CHANGE TITLE**, if desired. The screen title is displayed when cataloging the trace registers with **CATALOG REGISTER**. The screen title is not recalled with the limit-line table(s) or amplitude correction factors, however.
2. For saving limit-line tables, set up the limit-line table to be stored (see “Using the Limit-Line Functions” in this chapter). For amplitude correction factors, enter the data using the remote programming **AMPCOR** command or use **EXECUTE TITLE**. See “Entering Amplitude Correction Factors” in this chapter for more information about entering amplitude correction factors with **EXECUTE TITLE**.
3. Press **SAVE**. Press **INTRNL CRD** to select **INTRNL** if **CRD** is underlined.
4. Press **TRACE -> INTRNL**. This accesses a menu with **LIMIT LINES** and **AMPLTUD COR FACT**.
5. Press **LIMIT LINES** to save limit-line tables. Press **AMPLTUD COR FACT** to save amplitude correction factors. **REGISTER #** and **MAX REG # =** are displayed on the analyzer screen. The number after **MAX REG # =** indicates the maximum register number that can be entered for storage in analyzer memory.
6. Enter a number from 0 to the maximum register number using the numeric keypad and press **ENTER**.

## To Recall Limit-Line Tables or Amplitude Correction Factors

1. Press **RECALL**. Press **INTRNL CRD** to select **INTRNL** if **CRD** is underlined.
2. Press **INTRNL ->TRACE**. **INTRNL ->TRACE** accesses a menu with **LIMIT LINES** and **AMPLTUD COR FACT**.
3. Press **LIMIT LINES** to recall a limit-line table, **AMPLTUD COR FACT** to recall amplitude correction factors.
4. Enter the register number under which the data was stored.
5. Press **ENTER**.

If you want to protect all the state, trace, limit line, and amplitude correction data from being overwritten, press **SAVE**, **SAV LOCK ON OFF** so that **ON** is underlined.

Table 5-3 summarizes saving and recalling data to and from analyzer memory.

**Table 5-3. Summary of Save and Recall Operations, Analyzer Memory**

Operation	Screen Title Available?	Register Range	Key Sequence
SAVE STATE	No	1 to 8	<b>(SAVE)</b> STATE - >INTRNL (register number)
RECALL STATE	No	1 to 8*	<b>(RECALL)</b> INTRNL - >STATE (register number)†
SAVE TRACE	Yes	0 to MAX REG #	<b>(SAVE)</b> TRACE -> INTRNL (TRACE A , TRACE B , or TRACE C ) (register number) <b>(ENTER)</b>
RECALL TRACE	Yes	0 to MAX REG #	<b>(RECALL)</b> INTRNL - >TRACE (TRACE A , TRACE B , or TRACE C ) (register number) <b>(ENTER)</b> †
SAVE LIMIT LINE	Yes‡	0 to MAX REG #	<b>(SAVE)</b> TRACE -> INTRNL LIMIT LINES (register number) <b>(ENTER)</b>
RECALL LIMIT LINES	No	0 to MAX REG #	<b>(RECALL)</b> INTRNL - >TRACE LIMIT LINES (register number) <b>(ENTER)</b>
SAVE AMPLITUDE CORRECTION FACTORS	Yes‡	0 to MAX REG #	<b>(SAVE)</b> TRACE -> INTRNL AMPLTUD COR FACT (register number) <b>(ENTER)</b>
RECALL AMPLITUDE CORRECTION FACTORS	No	0 to MAX REG #	<b>(RECALL)</b> INTRNL - >TRACE AMPLTUD COR FACT (register number) <b>(ENTER)</b>

\* Registers 1—8 are available for the user to save a state. State register 0 contains the current state of the analyzer, state register 9 contains the previous state of the analyzer.

† The alternate method for recalling data uses the key sequence **(RECALL)**, CATALOG INTRNL , CATALOG REGISTER , use the step keys and knob to highlight the item to be recalled, LOAD FILE.

‡ The screen title is displayed when cataloging the trace registers with CATALOG REGISTER . The screen title is not recalled with the limit-line table(s) or amplitude correction factors.



## Saving and Recalling Data from the Memory Card

The memory card provides additional memory for saving instrument states, traces, limit-line tables, amplitude correction factors, and programs. Each battery-backed RAM card provides 32 kilobytes of memory. Instrument states, traces, limit-line tables, amplitude correction factors, and programs are easily retrievable without the need for an external controller to transfer data.

The process of saving and recalling data from the memory card is similar to saving and recalling data from the analyzer memory. Due to the expanded capabilities of the memory card, there are some important differences. For example, data is stored in analyzer memory as an item; on the memory card data is stored as a logical interchange file (LIF). Memory card data can be stored and recalled using a prefix. A prefix is an optional user-defined label for states, traces, and programs. The prefix becomes part of the file name. If you do not specify a prefix, a default file name is created. Table 5-4 compares the save and recall operations of analyzer memory and the memory card.

**Table 5-4. Comparison of Analyzer Memory and Memory Card Operations**

Mass Storage Device	Data Stored As	Stored with a Prefix?	Restriction on Register Number	Types of Data That Can Be Stored*	Catalog Functions Available
Analyzer Memory	Item	No	1 to 8 for states, 0 to MAX REG # for traces, limit lines, amplitude correction factors	States, traces, limit-line tables, amplitude correction factors	CATALOG ALL CATALOG REGISTER CATALOG VARIABLES CATALOG PREFIX CATALOG DLP LOAD FILE † DELETE FILE ‡
Memory Card	File	Yes	Prefix + register # ≤ 8 characters	States, traces, limit-line tables, amplitude correction factors, and downloadable programs	CATALOG ALL CATALOG STATES CATALOG TRACES CATALOG PREFIX CATALOG DLP CATALOG AMP CORR CATALOG LMT LINE LOAD FILE DELETE FILE

\* Specifies types of data that can be stored through normal front-panel operation.

† When cataloging analyzer memory, LOAD FILE is available for CATALOG REGISTER only.

‡ DELETE FILE is not available for CATALOG REGISTER.

## Preparing the Memory Card for Use

### Note



Improper insertion causes error messages to occur, but generally does not damage the card or instrument. Care must be taken, however, not to force the card into place. The cards are easy to insert when installed properly.

1. Locate the arrow printed on the card's label.
2. Insert the card with its arrow matching the raised arrow on the bezel around the card-insertion slot. See Figure 5-6.

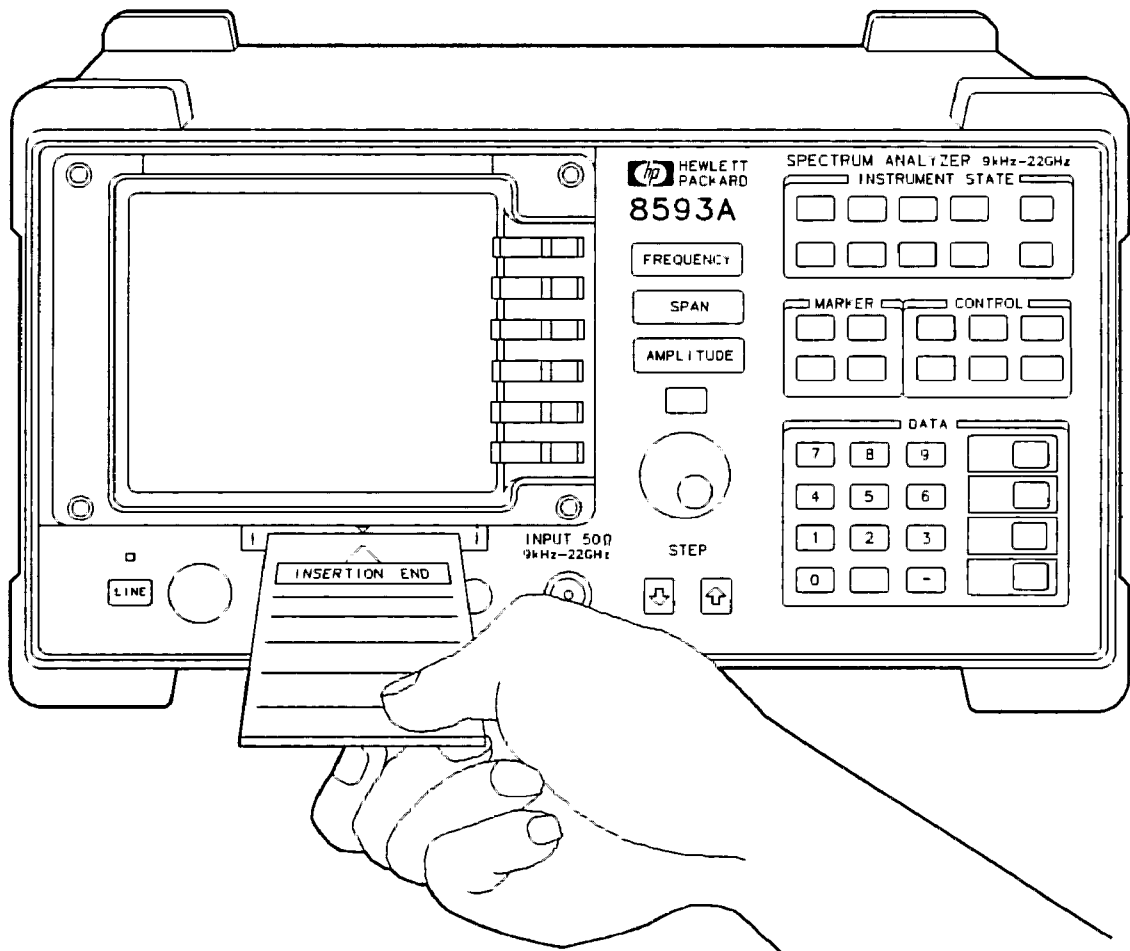

**Figure 5-6. Inserting the Memory Card**

3. Press the card into the slot. When correctly inserted, about 19 mm (0.75 in) of the card is exposed.
4. If this is a new memory card, it must be formatted before use. Since formatting a card deletes any data stored on the memory card, catalog the card before using the format card function if you suspect the memory card might contain data.

To format a new card, press **CONFIG**, **MORE 1 of 2**, **CARD CONFIG**, **FORMAT CARD**. The message **IF YOU ARE SURE, PRESS KEY AGAIN TO PURGE DATA** appears on the analyzer screen. Press **FORMAT CARD** again. (**FORMAT CARD** requires a double key press).

To catalog a memory card, press **CONFIG**, **MORE 1 of 2**, **CARD CONFIG**, **CATALOG CARD**. **CATALOG CARD** displays any existing data on the memory card (if the memory card has been formatted), or **INVALID CARD: DIRECTORY** if the card has not been formatted. Use the **BLANK CARD** if you wish to delete the files from the memory card.

## To Enter a Prefix

Memory card data can be stored and recalled using a prefix. To enter a prefix, press **DISPLAY** or **CONFIG**, **CHANGE PREFIX**.

Pressing **CHANGE PREFIX** accesses a menu containing the letters of the alphabet, the underscore symbol (**\_**), the number symbol (**#**), a space, and the clear function. To select a character, press the softkey that displays the group of characters that contains the desired character. The softkey menu changes to allow you to select an individual character. If you make a mistake, press **BK SP** to space back over the incorrect character. Additional characters are available by pressing **YZ\_# SPC CLEAR**, **MORE 1 of 2**. Numbers may be selected with the numeric keypad.

The prefix can be from one to seven characters long. The longer the prefix, the shorter the register number must be. The total length of the prefix and register number cannot exceed eight characters. The prefix can be any character; however, the underscore should not be the first character of the prefix.

An existing prefix can be cleared with the clear function. Press **CONFIG** or **DISPLAY**, **CHANGE PREFIX**, **YZ\_# SPC CLEAR**, **CLEAR** to clear the current prefix. To change a prefix, clear the existing prefix and then enter a new prefix.

## To Save a State

1. Press **DISPLAY** or **CONFIG**, **CHANGE PREFIX**. Use the softkeys to enter a prefix under which you want the state saved. A prefix can be one to seven characters long.

---

### Note



If there is not an existing prefix and you do not enter a prefix, the state data will be stored under a default file name consisting of "s," the underscore character (**\_**), and the register number you enter. If a prefix has been entered, the state data is saved under a file name which uses the prefix displayed on the analyzer screen.

---

2. Press **SAVE**. Press **INTRNL CRD** to select **CRD** if **INTRNL** is underlined. Selecting **CRD** selects the memory card as the mass storage device.
3. Press **STATE -> CARD**. **REGISTER #** and **PREFIX=** is displayed on the analyzer display.
4. Enter a register number using the numeric keypad and press **ENTER**.

The state data is saved with a file name consisting of an "s," the prefix that was entered, an underscore (**\_**), and the register number. The "s" denotes that the file contains state data.

## To Recall a State

1. Press **(SAVE)** or **(RECALL)**. Press **INTRNL CRD** to select CRD if INTRNL is underlined.
2. Press **CATALOG CARD**, **CATALOG STATES**. Use the knob to highlight the state data to be retrieved.
3. Press **LOAD FILE**.

State data can also be recalled by specifying the prefix and the register number:

1. Press **(RECALL)**. Press **INTRNL CRD** to select CRD if INTRNL is underlined.
2. Press **CARD -> STATE**.
3. Enter the register number the state was saved under, and **(ENTER)**.

---

### Note



If you want to recall a state saved under a different prefix, clear the existing prefix, use **CHANGE PREFIX** to enter the prefix, and then recall the state.

---

## To Save a Trace

Saving trace data saves the trace data and the state data.

1. Press **(DISPLAY)** or **(CONFIG)**, **CHANGE PREFIX** to enter a new prefix or change the existing prefix.

---

### Note



If you do not enter a new prefix, the existing prefix will be used. If there is not an existing prefix, the trace will be saved under t.(register number).

---

2. Enter a screen title with **(DISPLAY)**, **CHANGE TITLE**, if desired.
3. Set up the trace to be stored.
4. Press **(SAVE)**. Press **INTRNL CRD** to select CRD if INTRNL is underlined. **TRACE -> CARD**. This accesses a menu displaying **TRACE A**, **TRACE B**, **TRACE C**.
5. Press the softkey label of the trace that you want to save: **TRACE A**, **TRACE B**, or **TRACE C**. **REGISTER #** and **PREFIX=** are displayed on the analyzer display.
6. Enter a register number using the numeric keypad and press **(ENTER)**.

The trace data is saved with a file name consisting of a "t," the prefix that was entered, an underscore (\_), and the register number. The "t" denotes that the file contains trace data.

## To Recall a Trace

1. Press **SAVE** or **RECALL**. Press **INTRNL CRD** to select CRD if INTRNL is underlined.
2. Press **CATALOG CARD**, **CATALOG TRACES**. Use the knob to highlight the trace data to be retrieved.
3. Press **LOAD FILE**. The trace data is placed in trace B.

Trace data can also be recalled by specifying the prefix and the register number:

1. press **RECALL**. Press **INTRNL CRD** to select CRD if INTRNL is underlined.
2. Press **CARD -> TRACE**. **CARD -> TRACE** accesses the menu displaying **TRACE A**, **TRACE B**, and **TRACE C**.
3. Select the trace in which you want the trace data stored trace by pressing **TRACE A**, **TRACE B**, or **TRACE C**.
4. Enter the register number the trace was saved under and press **ENTER**. The recalled trace is placed in view mode.

---

### Note



If you want to recall a trace saved under a different prefix, use **CHANGE PREFIX** to enter the prefix and then recall the trace.

---

## To Save Limit-Line Tables or Amplitude Correction Factors

The procedure for saving limit-line tables or amplitude correction factors is similar to saving trace data. State and trace data is not recalled with limit-line table(s) or amplitude correction factors.

1. Press **DISPLAY** or **CONFIG**, **CHANGE PREFIX** to enter a new prefix or change the existing prefix.

---

### Note



If you do not enter a new prefix, the existing prefix will be used. If there is not an existing prefix, the limit-line table(s) will be saved under **L**(register number). Amplitude correction factors will be saved under **a**\_(register number).

---

2. For saving limit-line tables, set up the limit-line table to be stored (see "Using the Limit-Line Functions" in this chapter). For amplitude correction factors, enter the data using the remote programming **AMPCOR** command or use **EXECUTE TITLE**. See "Entering Amplitude Correction Factors" in this chapter for more information about entering amplitude correction factors with **EXECUTE TITLE**.
3. Press **SAVE**. Press **INTRNL CRD** to select CRD if INTRNL is underlined. **TRACE -> CARD**. This accesses a menu with **LIMIT LINES** and **AMPLTUD COR FACT**.
4. Press **LIMIT LINES** to save limit-line table(s), or **AMPLTUD COR FACT** to save amplitude correction factors. **REGISTER #** and **PREFIX=** are displayed on the analyzer display.

5. Enter a register number using the numeric keypad and press **ENTER**.

The data is saved with a file name consisting of a "1" (for limit-line tables), or "a" (for amplitude factors), the prefix that was entered, an underscore (-), and the register number.

### To Recall Limit-Line Tables or Amplitude Correction Factors

1. press **RECALL**. Press **INTRNL CRD** to select CRD if INTRNL is underlined.
2. Press **CARD -> TRACE**. **CARD -> TRACE** accesses the menu with **LIMIT LINES** and **AMPLTUD COR FACT**.
3. Press **LIMIT LINES** to recall limit-line table(s), or **AMPLTUD COR FACT** to recall amplitude correction factors.
4. Enter the register number the limit-line data or amplitude correction factors was saved under and press **ENTER**.

---

#### Note



If you want to recall limit-line data or amplitude correction factors saved under a different prefix, use **CHANGE PREFIX** to enter the prefix and then recall the trace.

---

---

#### Note



If **LOAD FILE** is used to recall limit-line files or amplitude correction factor files, the traces are set to the store-blank mode. Press **TRACE**, **CLEAR WRITE A** to view trace A data. Press **MEAS/USER**, **LIMITS ON OFF** (so that ON is underlined) to view limit lines.

---

### Saving and Recalling Programs with a Memory Card

Programs (also called downloadable programs or DLPs) can be loaded into analyzer memory by loading a program from a memory card, or defining a function with remote programming commands (remote programming ability is available with Option 021 or 023).

The process of saving and recalling programs from the memory card is similar to saving state data. To save program information to the memory card use **ALL DLP -> CARD**.

---

#### Note



**ALL DLP -> CARD** saves an image of the analyzer memory. This means a program cannot be saved selectively if several programs are present in the analyzer memory at the time. Use **CATALOG INTRNL**, **DELETE FILE** to delete the items in user memory that you do not wish to be saved on the memory card. **ALL DLP -> CARD** saves all programs and key definitions in analyzer memory on the memory card.

---

## To Save Programs

1. Press **CONFIG** or **DISPLAY**, **CHANGE PREFIX** to enter a new prefix or change the existing prefix.

---

### Note



If you do not enter a new prefix, the existing prefix will be used. If there is not an existing prefix, the program will be saved under d\_(register number).

---

2. Press **SAVE**. Press **INTRNL CRD** to select CRD if INTRNL is underlined.
3. Press **ALL DLP ->CARD . REGISTER #** and **PREFIX=** are displayed on the analyzer display.
4. Enter a register number using the numeric keypad and press **ENTER**.

The data is saved with a file name consisting of a “d,” the prefix that was entered, an underscore (-), and the register number. The “d” denotes that the file contains downloadable program data.

## To Recall Programs

1. Press **SAVE** or **RECALL**. Press **INTRNL CRD** to select CRD if INTRNL is underlined. (CRD is underlined when the memory card is selected).
2. Press **CATALOG CARD , MORE 1 of 2 , CATALOG DLP** . Use the knob to highlight the trace data to be retrieved.
3. Press **LOAD FILE** .

Programs can also be recalled by specifying the prefix and the register number:

1. Press **RECALL**. Press **INTRNL CRD** to select CRD if INTRNL is underlined.
2. Press **CARD -> DLP** , and enter the register number the program was saved under, and **ENTER**.

---

### Note



If you want to recall a program saved under a different prefix, use **CHANGE PREFIX** to enter the prefix and then recall the program.

---

Table 5-5 summarizes the save and recall functions using the memory card.

**Table 5-5. Save and Recall Functions Using Memory Card**

Operation	Screen Title Available?	Default File Name	Register Range	Key Sequence
SAVE STATE	No	s(current prefix) -(register #)	Prefix + register # ≤ 8 characters	<b>SAVE</b> STATE → CARD (register #) <b>ENTER</b>
RECALL STATE	No	N/A	Prefix + register # ≤ 8 characters	<b>RECALL</b> CARD →STATE (register #) <b>ENTER</b> *
SAVE TRACE	Yes	t(current prefix) -(register #)	Prefix + register # ≤ 8 characters	<b>SAVE</b> TRACE → CARD (TRACE A , TRACE B , or TRACE C ) (register #) <b>ENTER</b>
RECALL TRACE	Yes	N/A	Prefix + register # ≤ 8 characters	<b>RECALL</b> CARD →TRACE (TRACE A , TRACE B , or TRACE C ) (register #) <b>ENTER</b> *
SAVE LIMIT LINES	No	l(current prefix) -(register #)	Prefix + register # ≤ 8 characters	<b>SAVE</b> TRACE → CARD LIMIT LINES (register #) <b>ENTER</b>
RECALL LIMIT LINES	No	N/A	Prefix + register # ≤ 8 characters	<b>RECALL</b> CARD →TRACE LIMIT LINES (register #) <b>ENTER</b>
SAVE AMPLITUDE CORRECTION FACTORS	No	a(current prefix) -(register #)	Prefix + register # ≤ 8 characters	<b>SAVE</b> TRACE → CARD AMPLTUD COR FACT (register #) <b>ENTER</b>
RECALL AMPLITUDE CORRECTION FACTORS	No	N/A	Prefix + register # ≤ 8 characters	<b>RECALL</b> CARD →TRACE AMPLTUD COR FACT (register #) <b>ENTER</b>
SAVE DLP	No	d(current prefix) -(register #)	Prefix + register # ≤ 8 characters	<b>SAVE</b> ALL DLP →CARD (register #) <b>ENTER</b>
RECALL DLP	No	N/A	Prefix + register # ≤ 8 characters	<b>RECALL</b> CARD →DLP (register #) <b>ENTER</b> *
* An alternate method for recalling a file uses the key sequence: <b>RECALL</b> CATALOG CARD CATALOG ALL (use knob to highlight file) <b>LOAD FILE</b>				



## Using Limit-Line Functions

This section provides an overview of limit-lines, a procedure for creating an upper limit-line, and descriptions of the limit-line functions. A procedure for creating an upper and a lower limit-line is at the end of this section. See Chapter 7 for more information on a specific limit-line function.

Limit lines provide an easy way to compare trace data to a set of amplitude and frequency parameters while the spectrum analyzer is sweeping the measurement range. An upper and a lower limit-line can be displayed. Every measurement sweep of trace A is compared to the limit lines. If trace A is at or within the bounds of the limit lines, **LIMI PASS** is displayed. If trace A is out of the limit-line boundaries, **LIMI FAIL** is displayed. Figure 5-7 shows a sample limit-line display.

### Note



The upper limit-line is stored in trace B and the lower limit-line is stored in trace C; traces B and C are not available for active trace data. Trace A is available for active trace data.

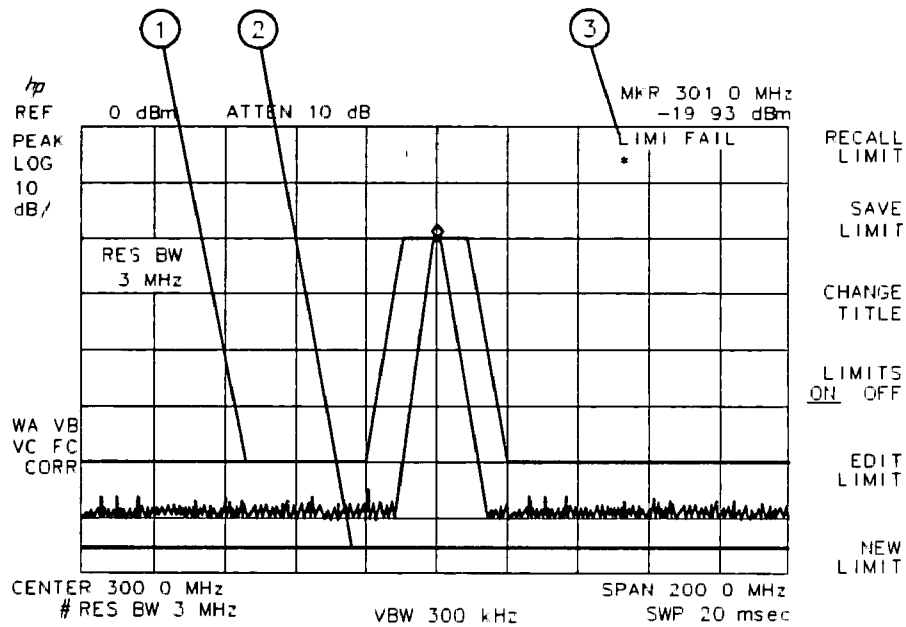

Figure 5-7. Typical Limit-Line Display

Index Number	Description
1	Upper limit-line.
2	Lower limit-line.
3	Screen message.

## Procedure for Creating an Upper Limit-Line

This procedure demonstrates how to create an upper limit-line and activate testing. Detailed descriptions of the limit-line functions follow this procedure.

1. Press **PRESET**.
2. Set the center frequency to 300 MHz, the span to 500 MHz by pressing **FREQUENCY**, 300 **MHz**, **SPAN** 500 **MHz**.
3. Connect CAL OUT to the analyzer input using an appropriate cable. (The calibration signal is used as the "test" signal for this demonstration.)

---

### Note



For Option 001 or 011, change the amplitude units to dBm. Press **AMPLITUDE**, MORE 1 of 2, **AMPTD UNITS**, dBm.

---

4. Press **MEAS/USER** to access the limit-line menus.
5. To clear an existing limit-line table, press **LIMIT LINES**, **NEW LIMIT**, **NEW LIMIT**.  
Or, if no limit-line table exists or you wish to edit an existing limit-line table, press **LIMIT LINES**, **EDIT LIMIT**.
6. Press **LIMITS FIX REL** so that **FIX** is underlined. **LIMITS FIX REL** specifies whether or not the limit line is relative to the analyzer's center frequency and reference level settings.
7. Press **EDIT UPPER**. **EDIT UPPER** allows you to edit or create an upper limit-line.
8. Press **SELECT SEGMENT**, 1 **ENTER**.
9. Press **SELECT FREQ**, 50 **MHz**.
10. Press **SELECT AMPLITUD**, 60 **-dBm**.
11. Press **SELECT TYPE**, then **FLAT**.

Steps 8 through 11 specified the first limit-line point. The first limit-line segment begins at 50 MHz and has an amplitude value of -60 dBm.

---

### Note



The coordinates for the second point must be entered before the first and second limit-line segments are displayed.

---

To enter the second limit-line segment:

12. Press **SELECT SEGMENT**, 2 **ENTER**.
13. Press **SELECT FREQ**, 250 **MHz**.
14. Press **SELECT AMPLITUD**, 60 **-dBm**.
15. Press **SELECT TYPE**, then **SLOPE**.

Steps 12 through 15 specified the second limit-line segment.

**Note**



The table entries can be edited if you make mistake. To edit an existing segment, use **SELECT SEGMENT** to specify the segment, and **SELECT FREQ**, **SELECT AMPLITUD**, or **SELECT TYPE** to specify the column you wish to edit.

Steps 16 through 23 specify the third and fourth limit-line segments.

16. Press **SELECT SEGMENT**, 3 **(ENTER)**.

17. Press **SELECT FREQ**, 400 **(MHz)**.

18. Press **SELECT AMPLITUD**, 15 **(-dBm)**.

19. Press **SELECT TYPE**, then **FLAT**.

You may notice that the end coordinate of segment three is drawn to off the top of the analyzer display. To avoid this, the frequency coordinate of the last segment should exceed the stop frequency of the analyzer display. Since the limit line in this procedure has only four segments specified, the frequency value of segment four (the last segment) is set to 600 MHz, greater than the stop frequency of the display (see step 21).

20. Press **SELECT SEGMENT**, 4 **(ENTER)**.

21. Press **SELECT FREQ**, 600 **(MHz)**.

22. Press **SELECT AMPLITUD**, 15 **(-dBm)**.

23. Press **SELECT TYPE**, then **POINT**.

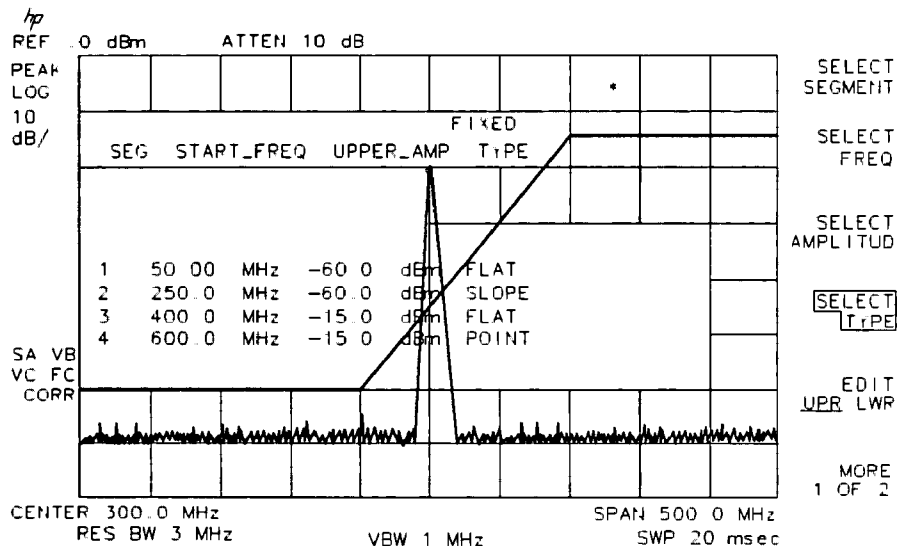

Figure 5-8. The Completed Limit-Line Table

24. Press **MORE 1 of 2**, **EDIT DONE** when all the segments have been entered.
25. Press **LIMITS ON OFF**. **LIMITS ON OFF** turns the limit testing on. **LIMI FAIL** is displayed because the calibration signal exceeds the limit line.
26. Disconnect **CAL OUT** from the analyzer input. **LIMI PASS** is displayed since no signal exceeds the limit line.

## Limit-Line Functions

This section describes the limit-line functions in the order that they are usually used.

### Editing or Viewing the Limit-Line Tables

Pressing **MEAS/USER**, then **LIMIT LINES** accesses the softkey menus for creating a limit line.

Pressing **NEW LIMIT**, **NEW LIMIT** clears an existing limit-line table.

---

### Note



**PRESET** turns limit-line testing off (if it is on), but does not clear an existing limit-line table. Use **NEW LIMIT** or **PURGE LIMITS** to clear an existing limit-line table.

---

Press **EDIT LIMIT** instead of **NEW LIMIT** to edit an existing limit line table or, if no limit-line table currently exists, create a limit-line table.

### Selecting the Type of Limit-Line Table

Pressing **LIMITS FIX REL** select the type of limit line. There are two types of limit lines: fixed and relative. Fixed limit-lines contain only absolute amplitude and frequency values. Relative limit-lines consist of frequency values referenced to the analyzer's center frequency, and amplitude values relative to the analyzer's reference level. For example, if a limit line is specified as fixed, entering a limit-line segment with a frequency coordinate of 300 MHz displays the limit-line segment at 300 MHz. If the same limit-line table is specified as relative, it is displayed relative to the analyzer's center frequency and reference level. If the center frequency is at 1.2 GHz, a relative limit-line segment with a frequency coordinate of 300 MHz will display the limit-line segment at 1.5 GHz. If the amplitude component of the relative limit-line segment is -10 dB, then -10 dB is added to the reference level value to obtain the amplitude of the given component.

**RELATIVE** is displayed in the limit-line table when the limit line type is relative; **FIXED** is displayed when limit-line type is fixed.

A limit line entered as fixed may be changed to relative, and one entered as relative may be changed to fixed. When changing between fixed and relative limit-lines, the frequency and amplitude values in the limit-line table change so that the limit line remains in the same position for the current frequency and amplitude settings of the spectrum analyzer.

### Selecting the Limit-Line Table Format

Press **EDIT UPPER**, **EDIT LOWER**, **EDIT UP/LOW**, or **EDIT MID/DELT** to edit or create a limit-line table. Each of the **EDIT** softkeys represents a different type of limit-line table format. The choice of **EDIT** softkey depends upon whether you want an upper limit-line only,

a lower limit-line only, an upper and lower limit-line, and the characteristics of the limit-line being entered.

The four limit-line table formats are described below:

- The upper limit-line table format (accessed by **EDIT UPPER**). With the upper limit-line table format, the coordinates of the upper limit-line are specified (but not for the lower limit-line). Even if lower limit-line values exist or the values had been entered as an upper and lower limit-line table, the upper limit-line values are treated as a separate table from the lower limit-line values. The upper limit-line entries can have independent frequency and amplitude coordinates from lower limit-line table entries.
- The lower limit-line table format (accessed by **EDIT LOWER**). With the lower limit-line table format, the coordinates for the lower limit-line are specified (but not for the upper limit-line). Even if upper limit-line values exist or the values had been entered as an upper and lower limit-line table, the lower limit-line values are treated as a separate table from the upper limit-line values. The lower limit-line entries can have independent frequency and amplitude coordinates from upper limit-line table entries.
- The upper and lower limit-line table format (accessed by **EDIT UP/LOW**). With the upper and lower limit-line table format, the upper and lower limit-lines can be entered at the same time. With the upper and lower limit-line format, the frequency, upper amplitude, and lower amplitude are specified. The frequency and upper amplitude comprise the coordinate point for the upper limit-line, the frequency and lower amplitude value comprise the coordinate point for the lower limit-line. It is not necessary to specify both an upper and lower amplitude component for every frequency component. Three asterisks indicate no amplitude value has been entered for the segment.
- The mid/delta limit-line table format (accessed by **EDIT MID/DELT**). Like the upper and lower limit-line table format, the mid/delta limit-line table format provides a means of specifying the upper and lower limit-lines at the same time. Unlike the upper and lower table format, the amplitude values are specified as a middle amplitude value with a delta (the upper and lower limit-lines are drawn an equal positive and negative distance from the middle amplitude). With the mid/delta format, the frequency and the mid-amplitude plus the delta comprise the upper limit-line; the frequency and the mid-amplitude minus the delta comprise the lower limit-line. The difference between the mid/delta and the upper/lower format is the way the amplitude values are entered; the frequency coordinate begins a segment regardless of the format chosen. The mid/delta format can be used if the upper and lower limit-lines are symmetrical (with respect to the amplitude axis).

---

**Note**

Regardless of which limit-line table format was used to enter the limit-line values, it is possible to edit the same limit-line values with any of the formats.

---

### Selecting the Segment Number

Pressing **SELECT SEGMENT** specifies the segment number to be entered or edited. Limit lines are created by entering frequency and amplitude values into a limit-line table. The frequency and amplitude values specify a coordinate point from which a limit-line segment is drawn. See Figure 5-9.

The coordinate point is the lowest frequency point of the line segment. Limit lines are constructed from left to right.

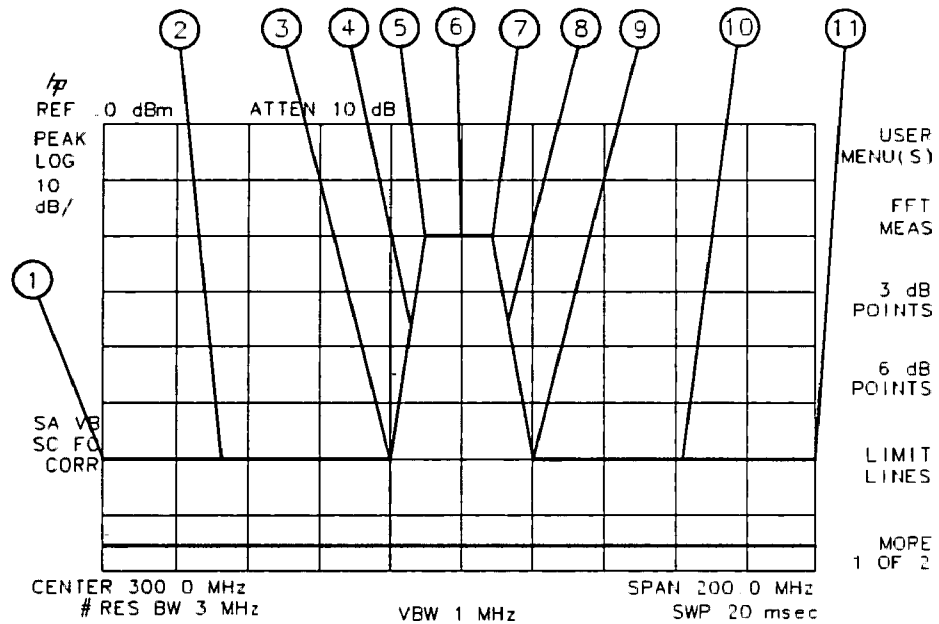

Figure 5-9. Limit-Line Segments

Index Number	Description
1	Frequency and amplitude coordinate that starts the first segment.
2	First segment.
3	Frequency and amplitude coordinate that starts the second segment
4	Second segment
5	Frequency and amplitude coordinate that starts the third segment.
6	Third segment.
7	Frequency and amplitude coordinate that starts the fourth segment.
8	Fourth segment.
9	Frequency and amplitude coordinate that starts the fifth segment.
10	Fifth segment.
11	Frequency and amplitude coordinate that starts the sixth segment.

Up to 20 segments can be specified for the upper or lower limit-line tables.

#### Selecting the Frequency Coordinate

Press **SELECT FREQ**, then enter a frequency value for the segment. Regardless of the table format, a frequency coordinate must be specified.

#### Note



There can be only one entry per frequency. Entering two segments with the same frequency in the same limit-line table overwrites the first entry.

---

**Note**

When entering a limit-line segment, the frequency, and amplitude values will be listed as asterisks (\*\*\*) until new values are entered. The new segment will be listed last until both the frequency and amplitude values have been entered. Once the frequency and at least one amplitude value are entered, the segment will be sorted into the limit-line table according to frequency.

---

**Selecting the Amplitude Coordinate**

In the previous procedure pressing **SELECT AMPLITUD** , then entering an amplitude value, specified the amplitude coordinate for the upper limit line. The limit-line table formats dictate how the amplitude values are treated:

- With the upper limit-line table format, one amplitude component (representing an upper limit-line segment) is specified per frequency component. The amplitude value is entered by pressing **SELECT AMPLITUD** , entering an amplitude value, and pressing a units key.
- With the lower limit-line table format, one amplitude component (representing a lower limit-line segment) is specified per frequency component. The amplitude value is entered by pressing **SELECT AMPLITUD** , entering an amplitude value, and pressing a units key.
- With the upper/lower limit-line table format, two amplitude components (one representing an upper limit-line segment and one representing a lower limit-line segment) can be specified per frequency component. It is not necessary to specify both an upper and lower amplitude value. For example, specifying only upper amplitude values results in an upper limit-line, but not a lower limit-line. The amplitude of the upper limit-line is entered by pressing **SELECT UPR AMPL** , entering an amplitude value, and pressing a units key. The amplitude of the lower limit-line is entered by pressing **SELECT LWR AMPL** , entering an amplitude value, and pressing a units key.
- With the mid/delta limit-line table format, two amplitude components (one representing a mid-amplitude value, one representing a deviation [positive and negative values] from either side of this value) is specified per frequency component. If no deviation is entered, the deviation defaults to zero. The middle amplitude value is entered by pressing **SELECT MID AMPL** , entering an amplitude value, and pressing a units key. The delta is entered by pressing **SELECT DLT AMPL** , entering an amplitude value, and pressing a units key.

---

**Note**

Frequency or amplitude values that are not within limit-line range will be modified. For example, a frequency value of 60 GHz will be modified to 30 MHz.

---

**Selecting the Segment Type**

Press **SEGMENT TYPE** , then **FLAT** , **SLOPE** , or **POINT** , to specify the segment type. The segment type determines how to connect the coordinate point of the current line segment with the coordinate point of the next line segment. The segment type determines whether the line segment is horizontal or vertical, sloped, or a single point. The three segment types are:

- **FLAT** draws a zero-slope line between the coordinate point of the current segment and the coordinate point of the next segment, producing limit-line values equal in amplitude for all

frequencies between the two points. If the amplitude values of the two segments differ, the limit-line will “step” to the value of the second segment. See Figure 5-10.

- SLOPE draws a straight line between the coordinate point of the current segment and the coordinate point of the next segment, producing limit-line values for all frequencies between the two points.
- POINT specifies a limit value for the coordinate point, and no other frequency points, so that a POINT segment specifies a limit value for a single frequency. For an upper limit-line, a POINT segment is indicated by a line drawn from the coordinate point, vertically off the top of screen. For a lower limit-line, a POINT segment is indicated by a line drawn from the coordinate point, vertically off the bottom of screen. The POINT segment type should be used as the last segment in the limit-line table. However, if the last segment in the table is not specified as the POINT segment type, an implicit point is automatically used. If a visible POINT segment at the right-hand edge of the display is not desired, add an explicit last point segment to the limit-line table that is higher in frequency than the stop frequency.

Figure 5-10 demonstrates the different segment types.

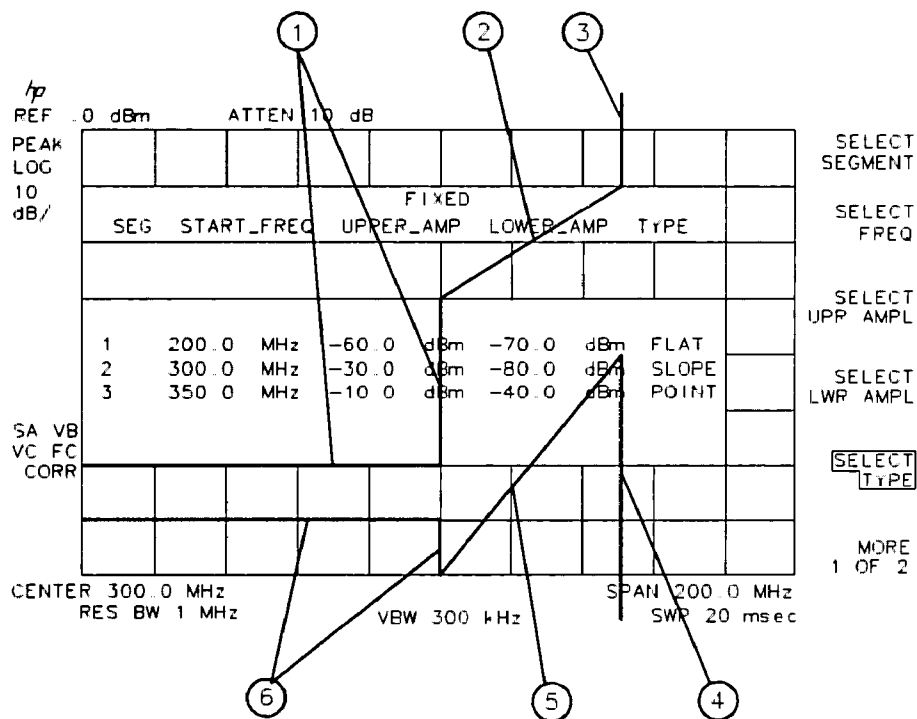

Figure 5-10. Segment Types



Index Number	Segment Types
1	Flat (upper limit-line)
2	Slope (upper limit-line)
3	Point (upper limit-line)
4	Point (lower limit-line)
5	Slope (lower limit-line)
6	Flat (lower limit-line)

### Completing Table Entry and Activating Limit-Line Testing

Pressing **EDIT DONE** blanks the limit-line table from the screen and accesses the menu with **LIMITS ON OFF**.

Pressing **LIMITS ON OFF** turns the limit-line testing on or off.

### Saving or Recalling Limit-Line Tables with **SAVE LIMIT** and **RECALL LIMIT**

Pressing **MEAS/USER**, **LIMIT LINES** accesses **SAVE LIMIT** and **RECALL LIMIT**. These softkey functions provide an easy way to save or recall current limit-line table(s). **SAVE LIMIT** saves the current limit-line table(s) in the current mass storage device (analyzer memory or memory card). To verify the current mass storage device, press **SAVE LIMIT**. If **MAX REG #** appears on the analyzer display, the current mass storage device is analyzer memory. If **PREFIX=** is displayed, the memory card is the mass storage device. (Press **SAVE** or **RECALL**, **INTRNL CRD** to change the current mass storage device.) Press **SAVE LIMIT**, enter a register number, then press **ENTER** to save the current limit-line table in analyzer memory or on the memory card.

**RECALL LIMIT** recalls limit-line table(s) from the current mass storage device (analyzer memory or memory card). To verify the current mass storage device, press **RECALL LIMIT**. If **MAX REG #** appears on the analyzer display, the current mass storage device is analyzer memory. If **PREFIX=** is displayed, the memory card is the mass storage device. (Press **SAVE** or **RECALL**, **INTRNL CRD** to change the current mass storage device.) To recall a limit line, enter the register number the limit-line table(s) was saved under, then press **ENTER**. When recalling a limit line from the memory card, it may be necessary the change the current prefix to the prefix the limit line was stored with. Use **CHANGE PREFIX** to change the current prefix.

### Procedure for Entering an Upper and Lower Limit-Line

This is a basic procedure for entering an upper and lower limit-line.

1. Press **PRESET**.
2. Since this procedure uses the calibration signal as the "test" signal, connect **CAL OUT** to the analyzer input with an appropriate cable.
3. Change the analyzer settings—center frequency at 300 MHz, span to 50 MHz, resolution bandwidth to 3 MHz by pressing **FREQUENCY**, 300 **MHz**, **SPAN** 50 **MHz**, **BW** 3 **MHz**.

4. Press **MEAS/USER** to access the limit-line menus.
5. To clear an existing limit-line table, press **LIMIT LINES , NEW LIMIT , NEW LIMIT**.  
Or, use **SAVE LIMIT** to save the current limit-line table in the current mass storage device before clearing the limit-line table. To save the current limit-line table, press **SAVE LIMIT**, enter the register number, then press **ENTER**. Or, if no limit-line table exists or you wish to edit an existing limit-line table, press **LIMIT LINES , EDIT LIMIT**.
6. Press **LIMITS FIX REL** so that **FIX** is underlined (fixed type of limit line).
7. Press **EDIT UP/LOW** to create upper and lower limit-lines simultaneously.
8. Press **SELECT SEGMENT , 1 ENTER**.
9. Press **SELECT FREQ , 275 MHz**.
10. Press **SELECT UPR AMPL , 60 -dBm**.
11. Press **SELECT LWR AMPL , 75 -dBm**.
12. Press **SELECT TYPE**, then **FLAT**.

Repeat steps 8 through 11, entering the following values:

Segment Number	Frequency	Upper Amplitude	Lower Amplitude	Type
2	290 MHz	-60 dBm	-75 dBm	Slope
3	295 MHz	-15 dBm	-75 dBm	Slope
4	297 MHz	-15 dBm	-75 dBm	Slope
5	300 MHz	-15 dBm	-29 dBm	Slope
6	303 MHz	-15 dBm	-75 dBm	Slope
7	305 MHz	-15 dBm	-75 dBm	Slope
8	310 MHz	-60 dBm	-75 dBm	Flat
9	400 MHz	-60 dBm	-75 dBm	Point

#### Note



When entering a limit-line segment, the frequency, and amplitude values will be listed as asterisks (\*\*\*) until new values are entered. The new segment will be listed last until both the frequency and amplitude values have been entered. Once the frequency and at least one amplitude value are entered, the segment will be sorted into the limit-line table according to frequency.

To edit an existing segment, use **SELECT SEGMENT** to specify the segment, and **SELECT FREQ**, **SELECT AMPLITUD**, or **SELECT TYPE** to specify the column you wish to edit.

13. Press **MORE 1 of 2 , EDIT DONE** when all values have been entered into the limit-line table.

14. Press **LIMITS ON OFF** so that **ON** is underlined. **LIMI PASS** is displayed on the analyzer screen if the measurement sweep is within the limit line(s). **LIMI FAIL** is displayed if the measurement sweep is not within the limit line(s).

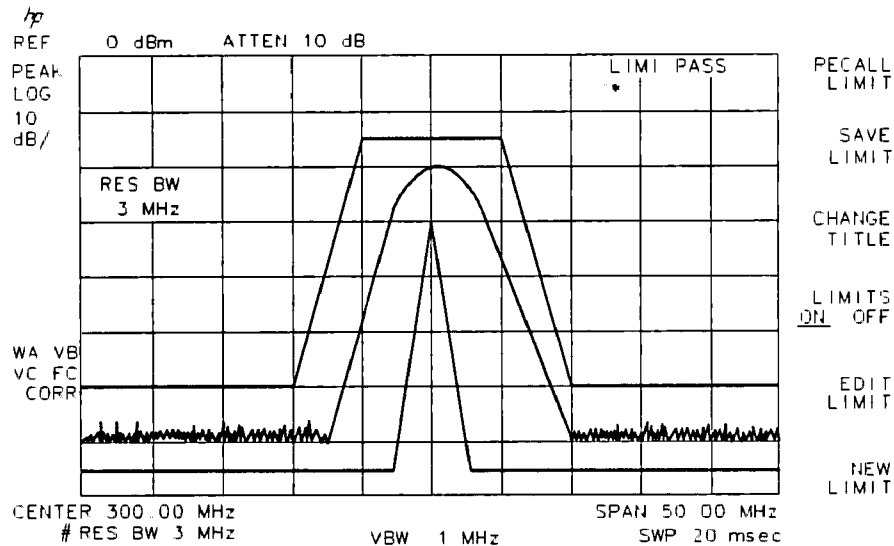

**Figure 5-11. Upper and Lower Limit-Line Testing**

To turn the limit-line testing on or off, use **LIMITS ON OFF**. Use **NEW LIMIT** or **PURGE LIMITS** to clear the limit-line tables. To remove the limit lines from the display, use **BLANK B** to blank the upper limit-line or **BLANK C** to blank the lower limit-line.

## Entering Amplitude Correction Factors

Amplitude correction factors provide a convenient way to compensate for the gain or loss of the measuring system. Amplitude correction factors can be entered into analyzer memory in three ways:

- For Option 021 or 023, use the remote programming command **AMPCOR**. See *HP 8590 Series Spectrum Analyzer Programming Manual* for more information.
- Load amplitude correction factors stored on a memory card into analyzer memory. See "To Recall Limit-Line Tables or Amplitude Correction Factors" in this chapter.
- For analyzers without Option 021 or 023, the frequencies and amplitude values are entered as the screen title and executed using **EXECUTE TITLE**. The frequency values must be entered in increasing order. To enter amplitude correction factors into analyzer memory using **EXECUTE TITLE**:

1. Press **DISPLAY**, **CHANGE TITLE**.
2. If necessary, clear the current screen title by pressing **YZ\_# SPC CLEAR**, **CLEAR**.

2. If necessary, clear the current screen title by pressing `YZ_# SPC CLEAR, CLEAR`.
3. Use the softkeys to enter `AMPCOR` as the screen title.
4. Use the keypad to enter the frequency value.
5. Use the softkeys to enter the frequency units. Use `GZ` for GHz, `MZ` for MHz, `KZ` for kHz, and `HZ` for Hz.
6. Use the softkeys to enter a comma.
7. Use the keypad to enter the amplitude value. If necessary, use the softkeys to enter a minus sign (use `+-<>=`, `- SUB`) before the amplitude value. It is not necessary to enter the amplitude units.
8. Use the softkeys to enter a comma.
9. Repeat steps 4 through 8 to enter the frequency and amplitude pairs. The frequency values must be in ascending order. The number of frequency and amplitude pairs that can be entered is restricted by the length of the screen title. Up to 53 characters can be entered in the screen title if the markers are off.
10. Terminate with a semicolon. Press `MORE 1 of 2, ( )',;:, ; SEMI` to enter a semicolon.
11. Press `(CAL)`, `MORE 1 of 3`, `MORE 2 of 3`, `SERVICE CAL`, `EXECUTE TITLE` to enter the amplitude correction factors into analyzer memory.

An "A" is displayed before "CORR" on the screen annotation when amplitude correction factors are in use.

For example, executing the screen title `AMPCOR 100MZ,5,1GZ,-5,1.5GZ,10;` adds the correction points (5 dB at 100 MHz, -5 dB at 1 GHz, and 10 dB at 1.5 GHz) across the active measurement range. Between points, the correction values are interpolated. When measuring at frequencies outside the first and last correction points, these values are used as the correction value.

Once amplitude correction factors have been loaded into analyzer memory, they remain in use until the analyzer is turned off, `(PRESET)` is pressed, or `AMPCOR OFF` is executed. Execute `AMPCOR ON` to turn the amplitude correction factors back on. To execute `AMPCOR OFF` or `AMPCOR ON`, use `CHANGE TITLE` to enter `AMPCOR OFF` or `AMPCOR ON` in the screen title.

Press `(CAL)`, `MORE 1 of 3`, `MORE 2 of 3`, `SERVICE CAL`, `EXECUTE TITLE` to execute the screen title.

If desired, save the amplitude correction factors in analyzer memory or on the memory card. See "To Save Limit-Line Tables or Amplitude Correction Factors" in this chapter.

---

## Changing the Analyzer's Power-On State

When the analyzer is turned on, it recalls the last analyzer state it was in when it was turned off. The turned-on state can be changed so that the last state of the analyzer is not recalled, and it is in the same state as it was after **PRESET** is pressed. The POWERON command is used to change the turned-on state of the analyzer. POWERON command can be executed remotely (Option 021 or 023 only; see *HP 8590 Series Spectrum Analyzer Programming Manual*), or with **EXECUTE TITLE**.

To execute POWERON using **EXECUTE TITLE**:

1. Press **DISPLAY**, **CHANGE TITLE**.
2. If necessary, clear the current screen title by pressing **YZ\_# SPC CLEAR**, **CLEAR**.
3. Use the softkeys to enter POWERON as the screen title.
4. Press **YZ\_# SPC CLEAR**, **SPACE** to enter a blank space.
5. Use the softkeys to enter IP to select instrument preset as the turned-on state of the analyzer. To select the last state of the analyzer (before it was turned off) as the turned-on state, enter LAST.
6. Press **MORE 1 of 2**, **()',;:, ; SEMI** to enter a semicolon. The screen title should read POWERON IP; or POWERON LAST;.
7. Press **CAL**, **MORE 1 of 3**, **MORE 2 of 3**, **SERVICE CAL**, **EXECUTE TITLE** to execute the POWERON command. The selected POWERON state can only be changed by the POWERON command.

---

## Using the External Keyboard

The external keyboard connector (available with Option 021 or 023) provides the capability of using an external keyboard with the analyzer. The external keyboard is not supplied with the analyzer. The external keyboard is a convenient way to enter screen titles, to enter remote programming commands, or to access the softkey functions.

### To Enter a Screen Title

1. Turn off the analyzer.

---

#### Caution



The analyzer *must* be turned off before connecting an external keyboard to the analyzer. Failure to do so may result in loss of factory correction constants.

- 
2. Connect an HP C1405 Option 2 cable from the rear-panel connection (marked EXT KEYBOARD) to the HP C1405A Option ABA keyboard.
  3. Press **LINE** to turn the analyzer on. The keyboard is now ready for entry of a screen title.
  4. Type in a screen title using the external keyboard. The entry appears at the top line of the analyzer display.

5. Press **ENTER** on the external keyboard. Pressing **ENTER** moves the characters to the position for the screen title annotation.

---

**Note**

To view more than 31 characters per line, turn off the time/date display with **CONFIG**, **TIMEDATE**, **TIMEDATE ON OFF (OFF)**.

---

### To Enter Programming Commands

1. Press **F8** on the external keyboard. This puts the keyboard in the execute remote command mode.
2. Type in a programming command (for example, type IP).
3. Press **ENTER** on the external keyboard.

**ENTER** causes the analyzer to perform the command.

---

**Note**

Unlike entering a remote programming command using an external controller, entering the remote programming commands with the external keyboard does not include the analyzer address. Also, semicolons are not required to terminate the programming line. Semicolons are necessary for separating the programming commands. For example, a program line is entered via the external controller as: `OUTPUT 718;"CF 300MHZ;SP 1MHZ;"`. The same programming line is entered using the external keyboard as: `CF 300MHZ;SP 1MHZ` **ENTER**.

---

After **F8** is pressed, the analyzer remains in command mode. To return to the title entry mode, press **PRESET** (on the analyzer) or **ESC** (on the external keyboard).

### To Enter a Prefix

The external keyboard can also be used to enter a prefix.

1. Press **F7** on the external keyboard. This puts the keyboard in the mode to enter a prefix.
2. Type in the prefix.
3. Press **ENTER** on the external keyboard.

See "External Keyboard Connector" in Chapter 7 for more information on the external keyboard functions.

**6. Analyzer Measurements  
and Applications**

## Analyzer Measurements and Applications

---

### What You'll Learn in This Chapter

This chapter demonstrates analyzer measurement techniques with examples of typical applications; each application focuses on different features. The measurement procedures covered in this chapter are listed below.

- Resolving signals of equal amplitude with resolution bandwidth.
- Resolving small signals hidden by large signals with the resolution bandwidth function.
- Increasing the frequency readout resolution using the marker counter.
- Decreasing the frequency span using the signal track function.
- Peaking signal amplitude with preselector peak (HP 8593A only).
- Tracking unstable signals with signal track while using maximum hold and minimum hold.
- Comparing signals with delta markers.
- Measuring low-level signals with attenuation, video bandwidth, and video averaging.
- Identifying distortion products using the RF attenuator and traces.
- Using the analyzer as a receiver in zero frequency span.
- Measuring amplitude modulation with the fast Fourier transform function.
- Measuring signals near band boundaries with harmonic lock (HP 8593A only).
- Stimulus-response measurements with the built-in tracking generator (Option 010 or 011).
- Demodulating and listening to an AM or FM signal (Option 102 only).
- Triggering on a selected line of a video picture field (Options 101 and 102 only).

To find descriptions of specific analyzer functions, turn to Chapter 7, "Analyzer Functions," or look in the index.



## Resolving Signals of Equal Amplitude with Resolution Bandwidth

In responding to a continuous-wave signal, a swept-tuned spectrum analyzer traces out the shape of the spectrum analyzer's intermediate frequency (IF) filters. As we change the filter bandwidth, we change the width of the displayed response. If a wide filter is used and two equal-amplitude input signals are close enough in frequency, then the two signals appear as one. Thus, signal resolution is determined by the IF filters inside the analyzer.

The resolution bandwidth (RES BW) function selects an IF filter setting for a measurement. Resolution bandwidth is defined as the 3 dB bandwidth of the filter. The 3 dB bandwidth tells us how close together equal amplitude signals can be and still be distinguished from each other.

Generally, to resolve two signals of equal amplitude, the resolution bandwidth must be less than or equal to the frequency separation of the two signals. A dip of approximately 3 dB is seen between the peaks of the two equal signals, and it is clear that more than one signal is present. See Figure 6-2.

In order to keep the analyzer calibrated, sweep time is automatically set to a value that is inversely proportional to the square of the resolution bandwidth. So, if the resolution bandwidth is reduced by a factor of 10, the sweep time is increased by a factor of 100 when sweep time and bandwidth settings are coupled. (Sweep time is proportional to  $1/BW^2$ ). For fastest measurement times, use the widest resolution bandwidth that still permits discrimination of all desired signals. The analyzer allows you to select from 1 kHz to 3 MHz resolution bandwidth in a 1, 3, 10 sequence, plus 5 MHz, for maximum measurement flexibility.

### Example:

Resolve two signals of equal amplitude with a frequency separation of 100 kHz.

1. To obtain two signals with a 100 kHz separation, connect the calibration signal and a signal source to the analyzer input as shown in Figure 6-1. (If available, two sources can be used.)

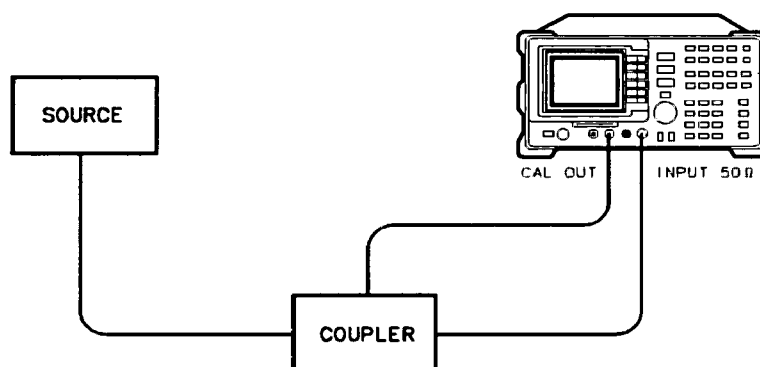
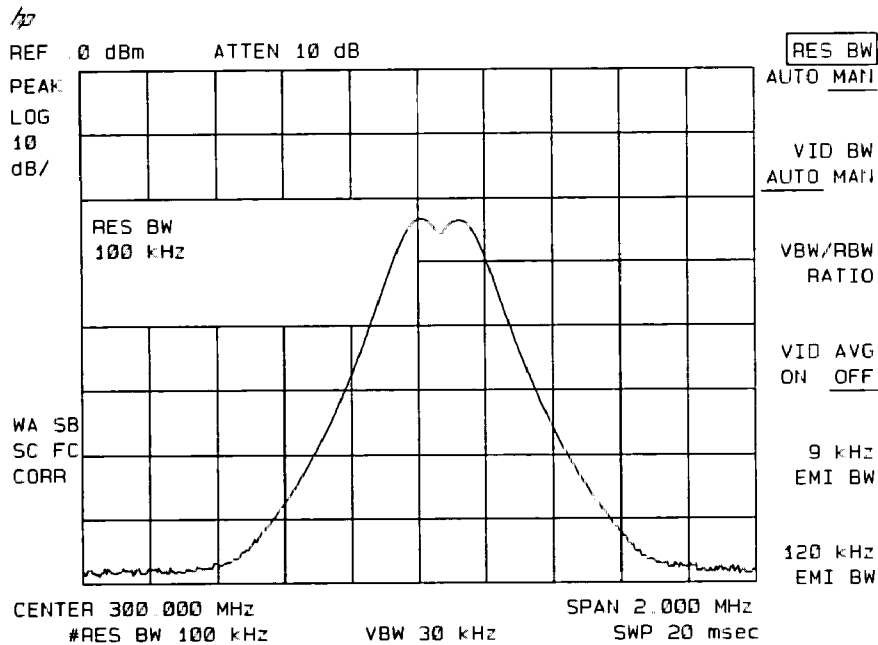

Figure 6-1. Set-Up for Obtaining Two Signals

2. If you are using the 300 MHz calibration signal, set the frequency of the source 100 kHz greater than the calibration signal (that is, 300.1 MHz). The amplitude of both signals should be approximately  $-20$  dBm.
3. On the analyzer, press **PRESET**. Set the center frequency to 300 MHz, the span to 2 MHz, and the resolution bandwidth to 300 kHz. Press **FREQUENCY**, 300 **MHz**, **SPAN**, 2 **MHz**, **BW**, 300 **kHz**. A single signal peak is visible.
4. Since the resolution bandwidth must be less than or equal to the frequency separation of the two signals, a resolution bandwidth of 100 kHz must be used. Change the resolution bandwidth to 100 kHz. Two signals are now visible as in Figure 6-2. Use the knob or step keys to further reduce the resolution bandwidth and better resolve the signals.



**Figure 6-2. Resolving Signals of Equal Amplitude**

As the resolution bandwidth is decreased, resolution of the individual signal is improved and the sweep time is increased. For fastest measurement times, use the widest possible resolution bandwidth. Under preset conditions, the resolution bandwidth is “coupled” (or linked) to span.

Since the resolution bandwidth has been changed from the “coupled” value, a “#” mark appears next to RES BW in the lower corner of the screen, indicating it is uncoupled. (Also see “AUTO COUPLE” in Chapter 7.)

**Note**



To resolve two signals of equal amplitude with a frequency separation of 200 kHz, the resolution bandwidth must be less than the signal separation, and resolution of 100 kHz must be used. The next larger filter, 300 kHz, would exceed the 200 kHz separation and would not resolve the signals.

---

## Resolving Small Signals Hidden by Large Signals with the Resolution Bandwidth Function

When dealing with resolution of signals that are not equal in amplitude, you must consider the shape of the IF filter as well as its 3 dB bandwidth. The shape of the filter is defined by the shape factor, which is the ratio of the 60 dB bandwidth to the 3 dB bandwidth. (Generally, the IF filters in this spectrum analyzer have shape factors of 15:1 or less.)

If a small signal is too close to a larger signal, the smaller signal can be hidden by the skirt of the larger signal. To view the smaller signal, you must select a resolution bandwidth such that  $k$  is less than  $a$ . See Figure 6-3.

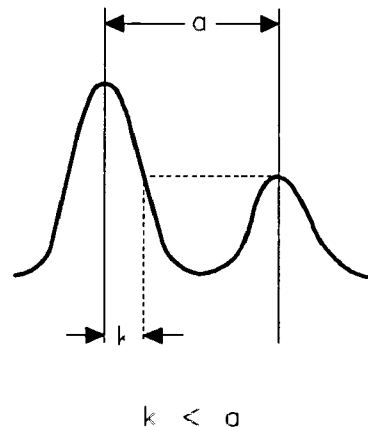

**Figure 6-3. Resolution Bandwidth Requirements for Resolving Small Signals**

The separation between the two signals must be greater than half the filter width of the larger signal at the amplitude level of the smaller signal.

**Example:** Resolve two input signals with a frequency separation of 200 kHz and an amplitude separation of 60 dB.

1. To obtain two signals with a 200 kHz separation, connect the equipment as shown in the previous section, “Resolving Signals of Equal Amplitude.”
2. Set the center frequency to 300 MHz and the span to 2 MHz.
3. Set the source to 300.2 MHz, so that the signal is 200 kHz higher than the calibration signal. Set the amplitude of the signal to  $-80$  dBm (60 dB below the calibration signal).
4. Set the 300 MHz signal to the reference level by pressing **PEAK SEARCH**, **MKR ->**, **MARKER -> REF LVL**.

If a 10 kHz filter with a typical shape factor of 15:1 is used, the filter will have a bandwidth of 150 kHz at 60 dB. The half-bandwidth (75 kHz) is narrower than the frequency separation, so the input signals will be resolved.

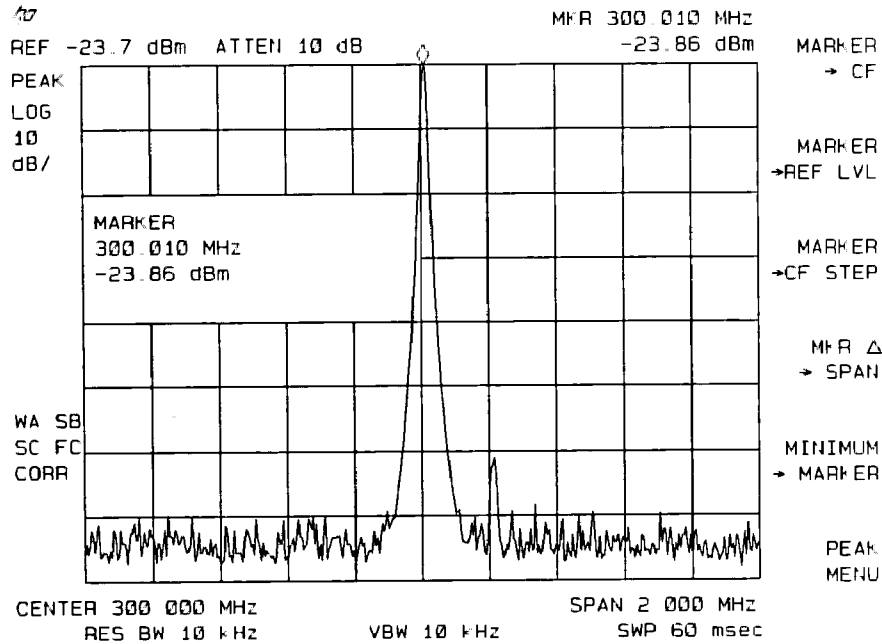

**Figure 6-4. Signal Resolution with a 10 kHz Resolution Bandwidth**

If a 30 kHz filter is used, the 60 dB bandwidth will be 450 kHz. Since the half-bandwidth (225 kHz) is wider than the frequency separation, the signals most likely will not be resolved. See Figure 6-5. (To determine resolution capability for intermediate values of amplitude level differences, consider the filter skirts between the 3 dB and 60 dB points to be approximately straight. In this case, we simply used the 60 dB value.)

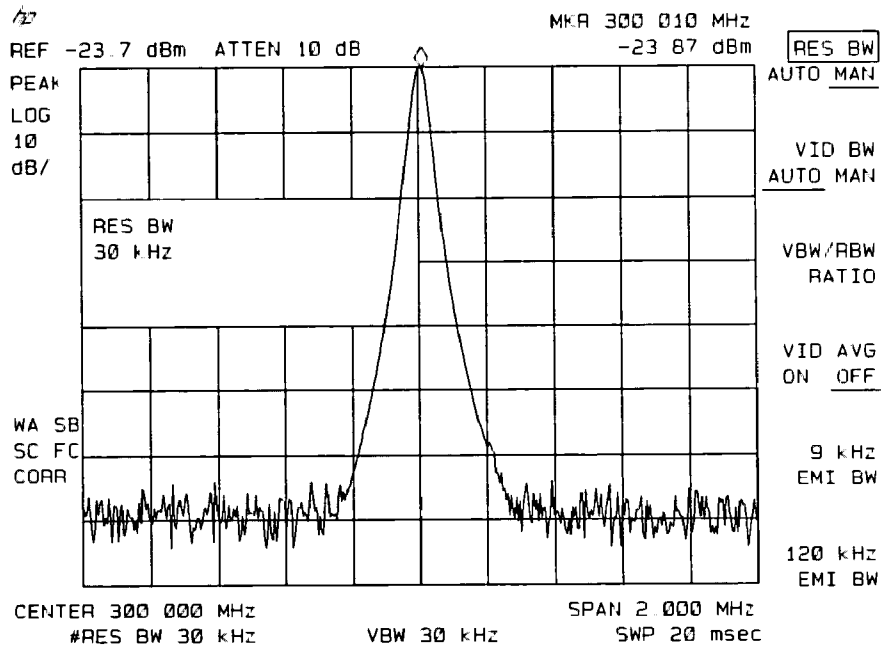

**Figure 6-5. Signal Resolution with a 30 kHz Resolution Bandwidth**

## Increasing the Frequency Readout Resolution Using the Marker Counter

The marker counter increases the resolution and accuracy of frequency readout. When using the marker count function, if the bandwidth to span ratio is too small (less than 0.01), \*DECR SPAN appears in the upper-right corner of the screen.

### Example:

1. Place a marker on the signal of interest. (If you are using the CAL OUT signal, place the marker on the 300 MHz calibration signal. Press **FREQUENCY**, 300 **MHz**, **SPAN**, 100 **MHz**, and **PEAK SEARCH**.)
2. Press **MKR**, **MKR CNT ON OFF** (ON should be underlined), to turn the marker counter on. **COUNTER** and the frequency and amplitude of the marker appear in the active function area.
3. Increase the counter resolution by pressing **MORE 1 of 2**, **CNT RES AUTO MAN** and entering the desired resolution using the step keys or the number/units keypad. For example, press 1 **kHz**. The marker counter readout is in the upper-right corner of the screen. The resolution can be set from 10 Hz to 100 kHz.
4. The marker counter remains on until turned off. Turn off the marker counter by pressing **MKR**, **MKR CNT ON OFF** (OFF should be underlined) or **MARKERS OFF**.

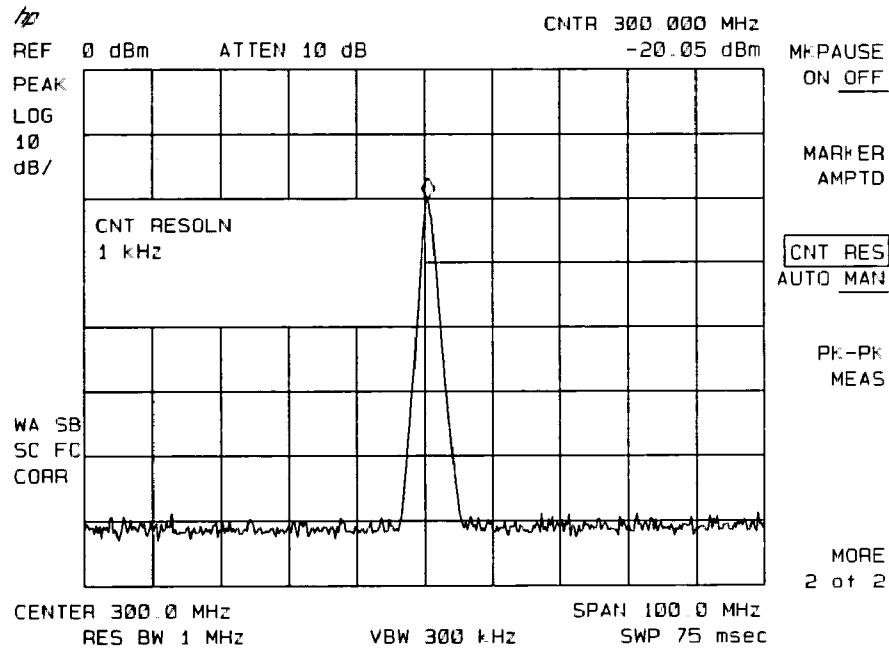

Figure 6-6. Using the Marker Counter

## Decreasing the Frequency Span Using the Signal Track Function

Using the spectrum analyzer's signal track function, you can quickly decrease the span while keeping the signal at center frequency.

**Example:** Examine a carrier signal in a 200 kHz span.

1. Press **PRESET** and tune to a carrier signal and place a marker at the peak. (If you are using the CAL OUT-signal, place the marker on the 300 MHz calibration signal. Press **FREQUENCY**, 300 **MHz**, **SPAN**, 200 **MHz**, and **PEAK SEARCH**.)
2. Press **SIGNAL TRACK** and the signal will move to the center of the screen, if it is not already positioned there (note that the marker must be on the signal). Because the signal track function automatically maintains the signal on the center of the screen, you can reduce the span quickly for a closer look. If the signal drifts off of the screen as you decrease the span, use a wider frequency span.
3. Press **SPAN**, 200 **kHz**. The span decreases in steps as automatic zoom is completed. You can also use the knob or step keys to decrease the span. See Figure 6-7.

Press **SIGNAL TRACK** again to turn off the tracking function.

### Note



When you are finished with the example, turn off the signal tracking function. (Signal track must be off for zero span). **ZERO SPAN** sets the span to zero and turns off the signal track function automatically.

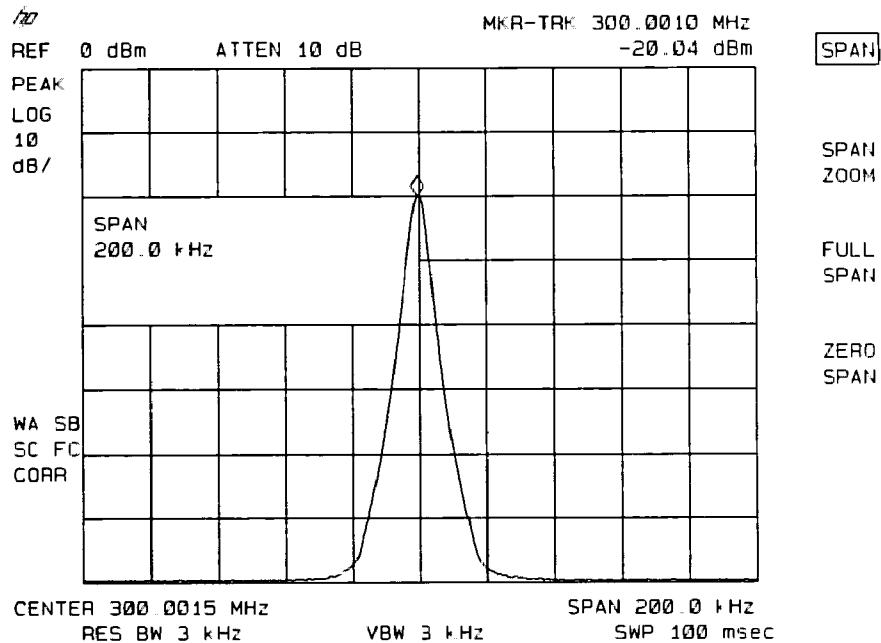

Figure 6-7. After Zooming In on the Signal

## Peaking Signal Amplitude with Preselector Peak (HP 8593A Only)

Preselector peak automatically adjusts the preselector tracking to peak the signal at the active marker. Using preselector peak prior to measuring a signal yields the most accurate amplitude reading at the specified frequency. To maximize the peak response of the preselector and adjust the tracking, tune the marker to a signal and press **AMPLITUDE**, **PRESEL PEAK**.

### Note



**PRESEL PEAK** maximizes the peak response of the signal of interest but may degrade the frequency response at other frequencies. Use **PRESEL DEFAULT** or **PRESET** to clear **PRESEL PEAK** before measuring another frequency.

**PRESEL DEFAULT** provides best full single-band flatness for viewing several signals simultaneously.

### Note



**PRESEL PEAK** works in harmonic bands only (bands 1 through 4).

**Example:** Using the knob, step keys, or **PEAK SEARCH**, place the marker on your signal, and press **PRESEL PEAK**. The message **CAL:PEAKING** appears in the active function block while the routine is working.

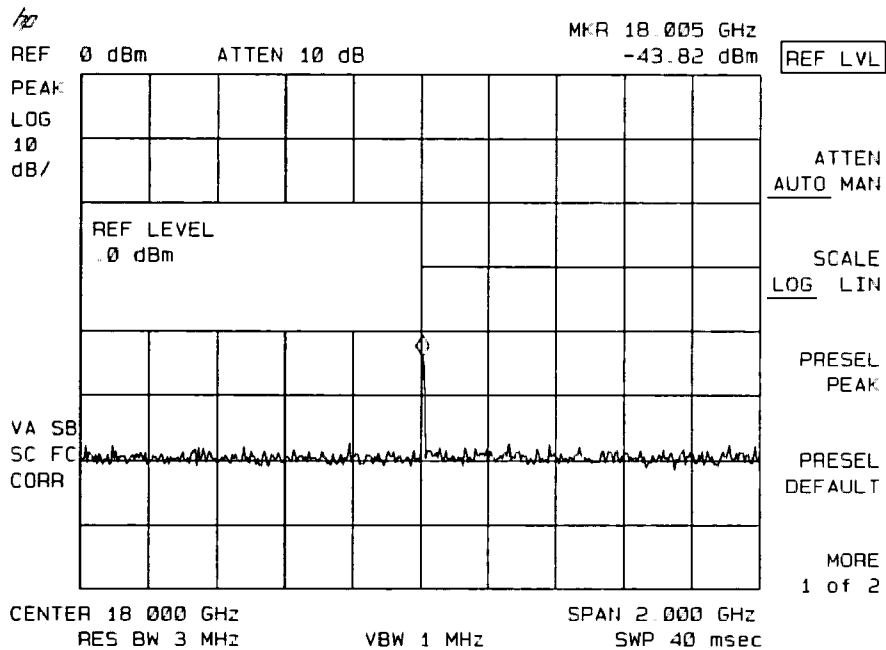

**Figure 6-8. Peaking Signal Amplitude with Preselector Peak**

---

## Tracking Unstable Signals with Signal Track while Using Maximum Hold and Minimum Hold

The signal track function is useful for tracking unstable signals that drift with time. Maximum hold and minimum hold are useful for displaying modulated signals which appear unstable, but have an envelope that contains the information-bearing portion of the signal.

**SIGNAL TRACK** may be used to track these unstable signals. Use **PEAK SEARCH** to place a marker on the highest signal on the display. Use **SIGNAL TRACK** to bring that signal to the center frequency of the graticule and adjust the center frequency every sweep to bring the selected signal point back to the center. **SPAN ZOOM** is a quick way to perform the **PEAK SEARCH**, **SIGNAL TRACK**, **SPAN** key sequence.

Note that the primary function of the signal track function is to track unstable signals, not to track a signal as the center frequency of the analyzer is changed. If you choose to use the signal track function when changing center frequency, check to ensure that the signal found by the tracking function is the correct signal.

**Example:** Use signal track to keep a drifting signal at the center of the display and monitor its change.

This example requires a modulated signal which can be easily found by connecting an antenna to the analyzer input and tuning to the FM broadcast band (88 to 108 MHz), nominally 100 MHz with a span of 20 MHz, an attenuator setting of 0 dB, and reference level of approximately -40 dBm. Your circumstances may be slightly different, depending on building shielding and proximity to transmitters.

1. Connect an antenna to the analyzer input.
2. Press **PRESET**, **FREQUENCY**, 100 **MHz**. Press **SPAN**, 20 **MHz**.

---

**Note** Use a different signal frequency if no signal is available at 100 MHz in your area.



3. Press **AMPLITUDE**, 40 **-dBm**. Press **ATTEN AUTO MAN**, 0 **+dBm**.
4. Press **SPAN**, **SPAN ZOOM**, 500 **kHz**.

Notice that the signal has been held in the center of the display.

---

**Note** If the signal you selected drifts too quickly for the analyzer to keep up with, use a wider span.



5. The signal frequency drift can be read from the screen if both the signal track and marker delta functions are active. Press **MARKER**, **MARKER DELTA**, **SIGNAL TRACK**; the marker readout indicates the change in frequency and amplitude as the signal drifts. (See Figure 6-9.)



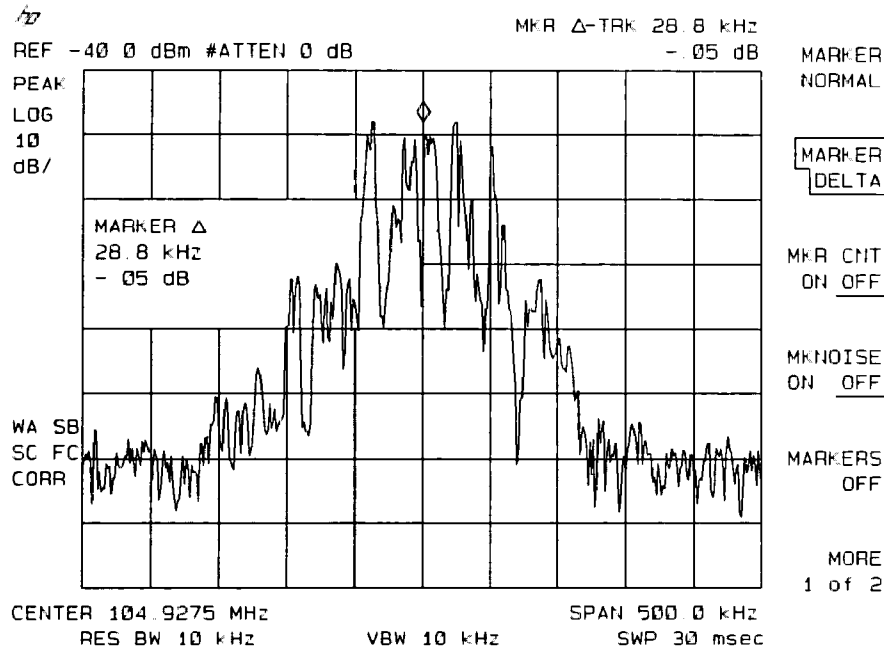

**Figure 6-9. Using Signal Tracking to Track an Unstable Signal**

The spectrum analyzer can measure the short- and long-term stability of a source. The maximum amplitude level and the frequency drift of an input signal trace can be displayed and held with the maximum-hold function. The minimum amplitude level can be displayed with minimum hold (available for trace C only).

You can use the maximum-hold and minimum-hold functions if, for example, you want to determine how much of the frequency spectrum an FM signal occupies.

**Example:** Using the maximum-hold and minimum hold functions, monitor the envelopes of a signal.

1. Connect an antenna to the analyzer input.
2. Press **PRESET**, **FREQUENCY**, 100 **MHz**. Press **SPAN**, 20 **MHz**.
3. Press **AMPLITUDE**, 40 **-dBm**. Press **ATTEN AUTO MAN**, 0 **+dBm**. Press **SPAN**, **SPAN ZOOM**, 500 **kHz**.

Notice that the signal has been held in the center of the display.

4. Turn off the signal track function by pressing **SIGNAL TRACK**.
5. To measure the excursion of the signal, press **TRACE**, **MAX HOLD A**. As the signal varies, maximum hold maintains the maximum responses of the input signal, as shown in Figure 6-10.

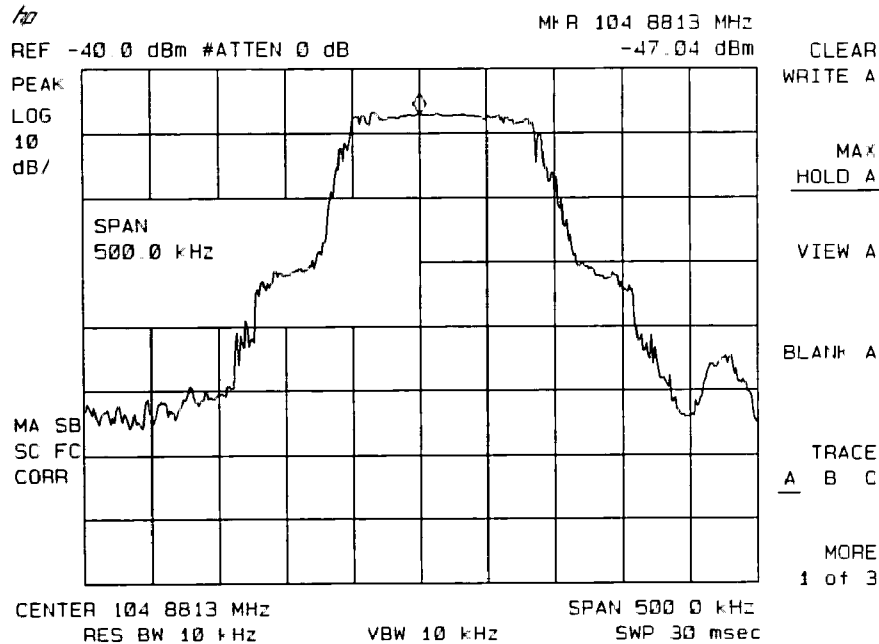

**Figure 6-10. Viewing an Unstable Signal Using Max Hold A**

Annotation on the left side of the screen indicates the trace mode. For example, MA SB SC indicates trace A is in maximum-hold mode, trace B and trace C are in store-blank mode. (See "Screen Annotation" in Chapter 5.)

6. Press **TRACE**, TRACE A B C to select trace B. (Trace B is selected when B is underlined.) Press **CLEAR WRITE B** to place trace B in clear-write mode, which displays the current measurement results as it sweeps. Trace A remains in maximum-hold mode, showing the frequency shift of the signal.
7. Press **TRACE** A B C to select trace C (C should be underlined). Press **MIN HOLD C**. Trace C is in the minimum-hold mode and displays the minimum amplitude of the frequency drift of the signal.

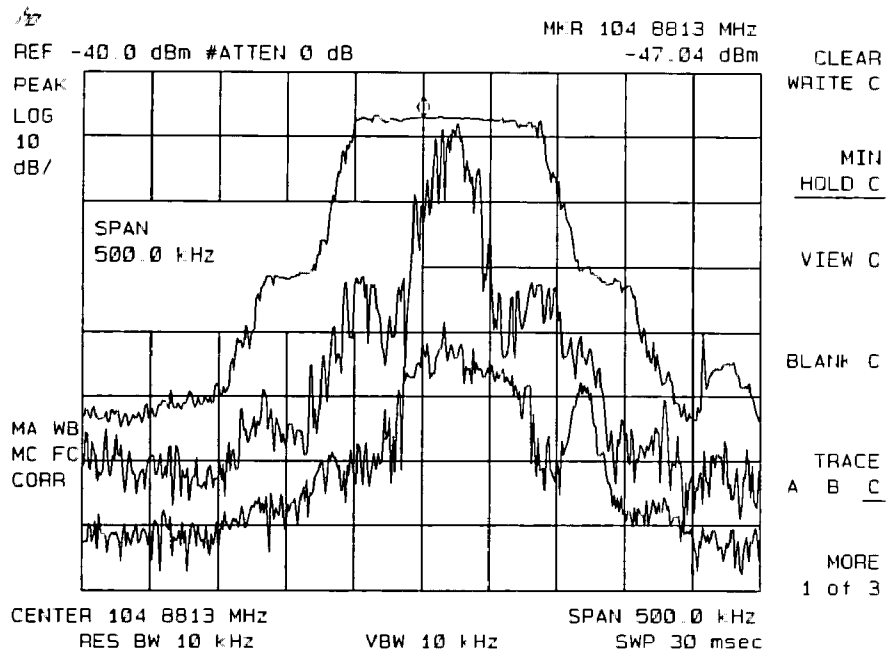

**Figure 6-11. Viewing an Unstable Signal With Max Hold, Clear Write, and Min Hold**

## Comparing Signals with Delta Markers

With the spectrum analyzer, you can easily compare frequency and amplitude differences between signals, such as radio or television signal spectra. The spectrum analyzer's delta marker function lets you compare two signals when both appear on the screen at one time or when only one appears on the screen.

**Example:** Measure the differences between two signals on the same display screen.

1. Connect the CAL OUT to the analyzer input on the front panel. Press **PRESET**. For the HP 8593A only, set the center frequency to 900 MHz and the span to 1.8 GHz.

The calibration signal and its harmonics appear on the display.

2. Press **PEAK SEARCH** to place a marker at the highest peak on the display. The **NEXT PK RIGHT** and **NEXT PK LEFT** softkeys move the marker from peak to peak. Press **NEXT PK RIGHT** to move the marker to the 300 MHz calibration signal. See Figure 6-12.

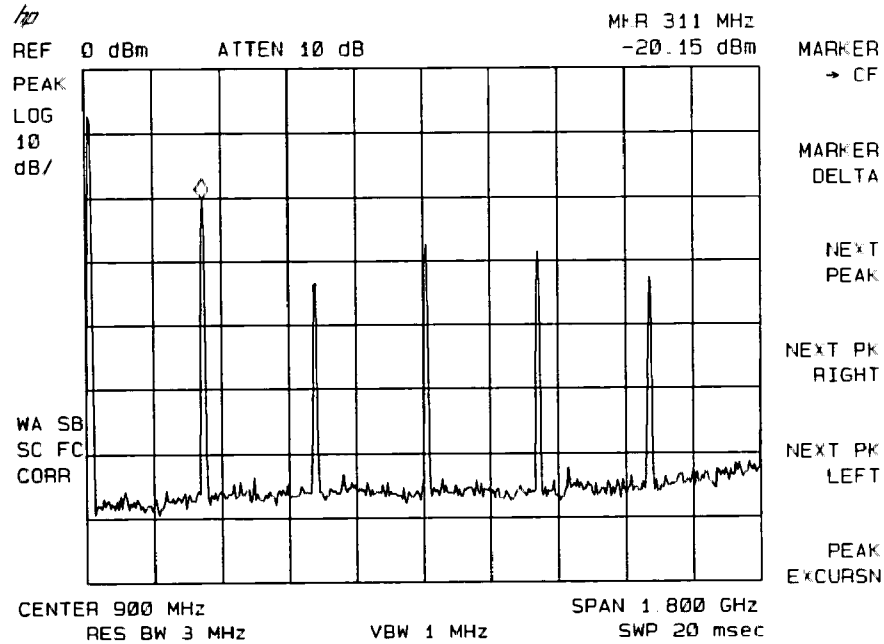

**Figure 6-12. Placing a Marker on the CAL OUT Signal**

The signal that appears at the left edge of the screen is the spectrum analyzer's local oscillator (LO) and represents 0 Hz.

3. Press **MARKER DELTA** to activate a second marker at the position of the first marker. Move the second marker to another signal peak with the **NEXT PK RIGHT** or **NEXT PK LEFT** softkeys.

You may also use the knob to move the second marker.

4. The amplitude and frequency difference between the markers is displayed in the active function block and in the upper-right corner of the screen. See Figure 6-13.

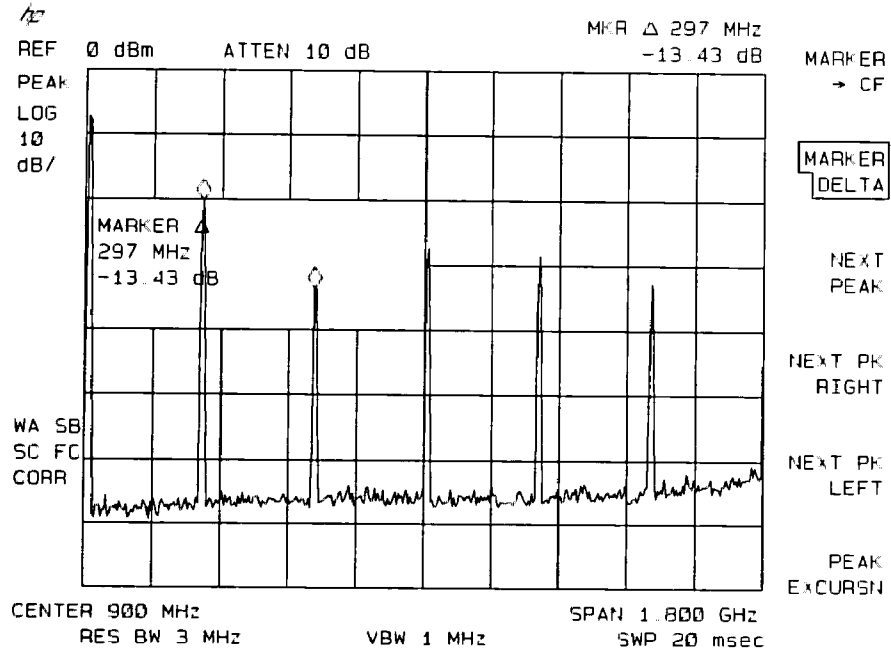

**Figure 6-13. Using the Marker Delta Function**

Press **MKR**, **MARKERS OFF** to turn the markers off.

5. The **DELTA MEAS** softkey also finds and displays the frequency and amplitude difference between the two highest-amplitude signals. To use this automatic function, first remove the local oscillator (LO) signal from the display by pressing **FREQUENCY**, **START FREQ**, and turning the knob until the LO signal at 0 Hz is off the screen. Press **MEAS/USER**, **MORE 1 of 2**, **DELTA MEAS**. See Figure 6-14.

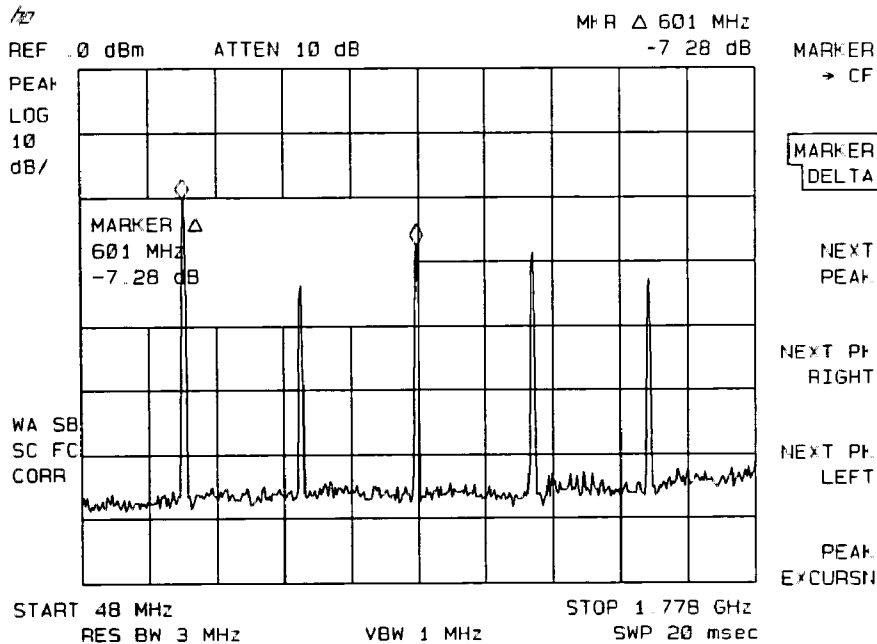

**Figure 6-14. Using the Delta Meas Function**

The frequency and amplitude differences between the signals appear in the active function block. In addition, the softkeys accessed by **PEAK SEARCH** appear on the screen.

**Example:** Measure the frequency and amplitude difference between two signals that do not appear on the screen at one time. (This technique is useful for harmonic distortion tests when narrow span and narrow bandwidth are necessary to measure the low-level harmonics.)

1. Connect the CAL OUT to the analyzer input (if you have not already done so). Press **PRESET**, **FREQUENCY**, 300 **MHz**, **SPAN** and the step down key (**▼**) to narrow the frequency span until only one signal appears on the screen.
2. Press **PEAK SEARCH** to place a marker on the peak.
3. Press **MARKER DELTA** to identify the position of the first marker.
4. Press **FREQUENCY** to activate center frequency. Turn the knob clockwise slowly to adjust the center frequency until a second signal peak is placed at the position of the second marker. It may be necessary to pause occasionally while turning the knob to allow a sweep to update the trace. The first marker remains on the screen at the amplitude of the first signal peak.

---

**Note** Changing the reference level changes the marker delta amplitude readout.





---

The annotation in the upper-right corner of the screen indicates the amplitude and frequency difference between the two signals. See Figure 6-15.

To turn the markers off, press **MKR** and **MARKERS OFF**.

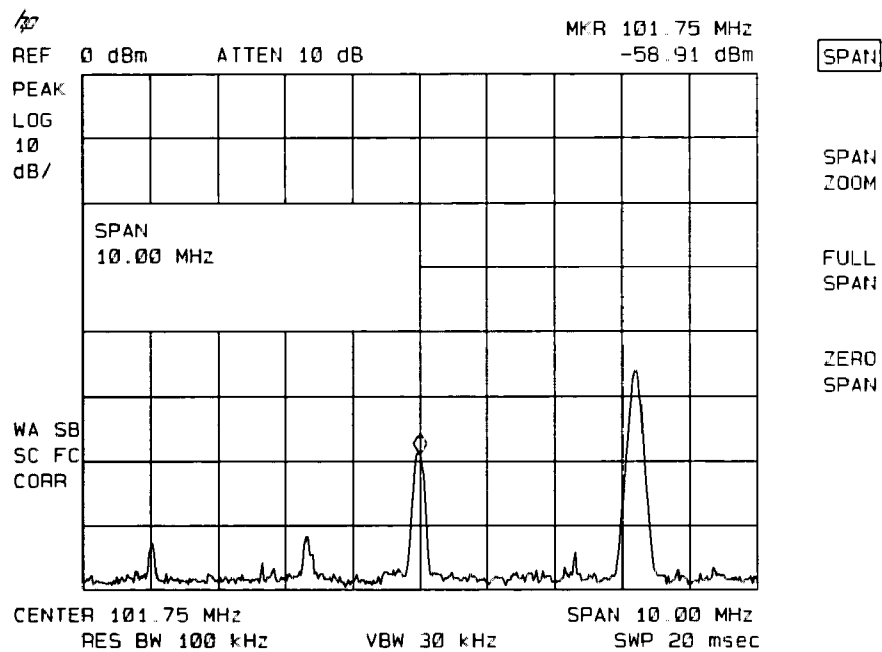

2. Reduce the frequency range to view a low-level signal of interest. For example, narrow the frequency span from 88 MHz to 108 MHz by pressing **FREQUENCY**, **START FREQ**, 88 **MHz**, **STOP FREQ**, 108 **MHz**.
3. Place a marker on the low-level signal of interest. Press **MKR** and use the knob to position the marker at the signal's peak.
4. Place the signal at center frequency by pressing **MKR ->**, **MARKER -> CF**.
5. Reduce the span to 10 MHz. Press **SPAN**, and then use the step down key (**▼**). See Figure 6-16.



**Figure 6-16. Low-Level Signal**

6. Press **AMPLITUDE**, **ATTEN AUTO MAN**. Press the step up key once to select 20 dB attenuation. Increasing the attenuation moves the noise floor closer to the signal. A “#” mark appears next to **ATTEN**, indicating the attenuation is no longer coupled.
7. To see the signal more clearly, press 0 **dBm**. Zero attenuation makes the signal more visible. (As a precaution to protect the spectrum analyzer’s input mixer, 0 dB RF attenuation can be selected only with the number/units keypad.)



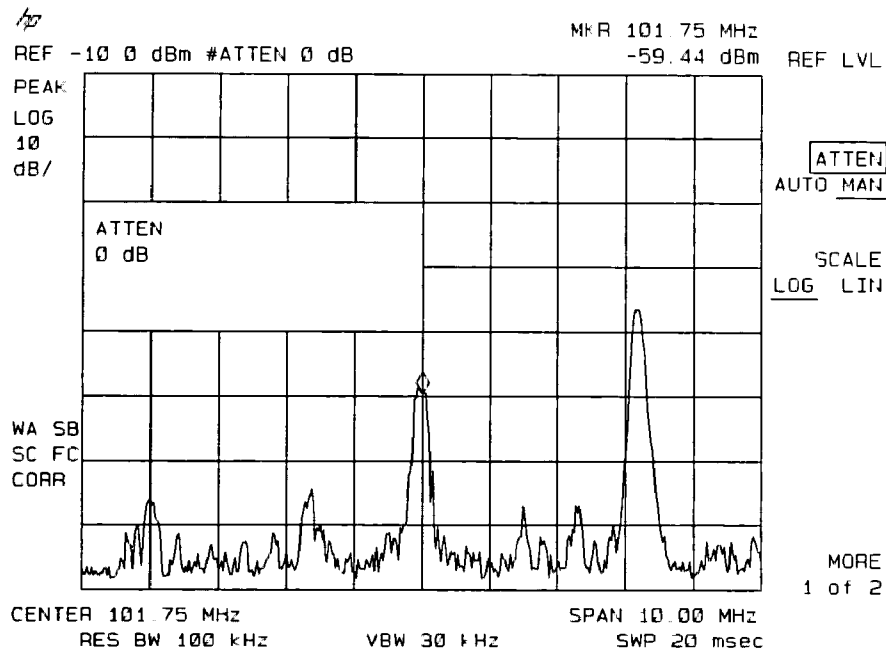
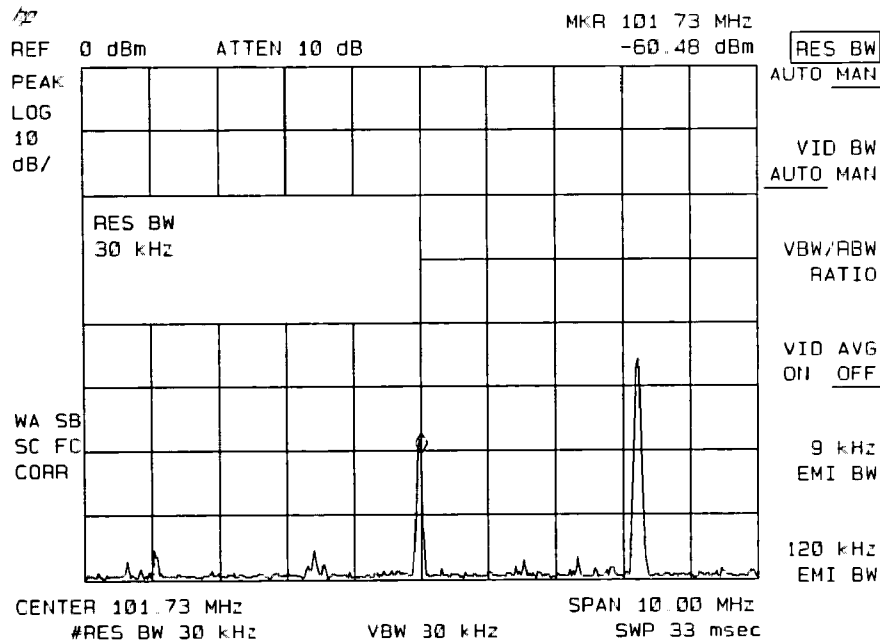

**Figure 6-17. Using 0 dB Attenuation**

Before connecting other signals to the analyzer input, increase the RF attenuation to protect the analyzer's input mixer by pressing **ATTEN AUTO MAN** so that **AUTO** is underlined, or press **AUTO COUPLE**, **AUTO ALL**.

**Example:** The resolution bandwidth can be decreased to view low-level signals.

1. As in the previous example, connect an antenna to the analyzer input. Set the analyzer to view a low-level signal.
2. Press **BW**, **▼**. The low-level signal appears more clearly because the noise level is reduced. See Figure 6-18.



**Figure 6-18. Decreasing Resolution Bandwidth**

A “#” mark appears next to RES BW on the left corner of the screen, indicating that the resolution bandwidth is uncoupled.

As the resolution bandwidth is reduced, the sweep time is increased to maintain calibrated data.

**Example:** The video-filter control is useful for noise measurements and observation of low-level signals close to the noise floor. The video filter is a post-detection low-pass filter that smooths the displayed trace. When signal responses near the noise level of the analyzer are visually masked by the noise, the video filter can be narrowed to smooth this noise and improve the visibility of the signal. (Reducing video bandwidths requires slower sweep times to keep the analyzer calibrated.)

Using the video bandwidth function, measure the amplitude of a low-level signal.

1. As in the first example, connect an antenna to the analyzer input. Set the analyzer to view a low-level signal.
2. Narrow the video bandwidth by pressing **[BW]**, **VID BW AUTO MAN**, and press the step down key (**[▼]**). This clarifies the signal by smoothing the noise, which allows better measurement of the signal amplitude.

A “#” mark appears next to VBW on the screen, indicating that the video bandwidth is not coupled to the resolution bandwidth.

Instrument preset conditions couple the video bandwidth to the resolution bandwidth so that the video bandwidth is equal to or narrower than the resolution bandwidth. If the bandwidths are uncoupled when video bandwidth is the active function, pressing **VID BW AUTO MAN** (so that AUTO is underlined) recouples the bandwidths. See Figure 6-19.



2. Press **TRACE**, **MORE 1 of 3**, **VID AVG ON OFF**. When ON is underlined, the video-averaging routine is initiated. As the averaging routine smooths the trace, low-level signals become more visible. **VID AVG 100** appears in the active function block.

The number represents the number of samples (or sweeps) taken to complete the averaging routine.

To set the number of samples, use the number/units keypad. For example, press **VID AVG-ON-OFF** (so that ON is underlined), **25 Hz**. Turn video averaging off and on again by pressing **VID AVG ON OFF (OFF)**, **VID AVG ON OFF (ON)**.

The number of samples equals the number of sweeps in the averaging routine.

During averaging, the current sample appears at the left side of the graticule. Changes in active functions settings, such as the center frequency or reference level, will also restart the sampling, or turning video averaging off and then on again will restart sampling.

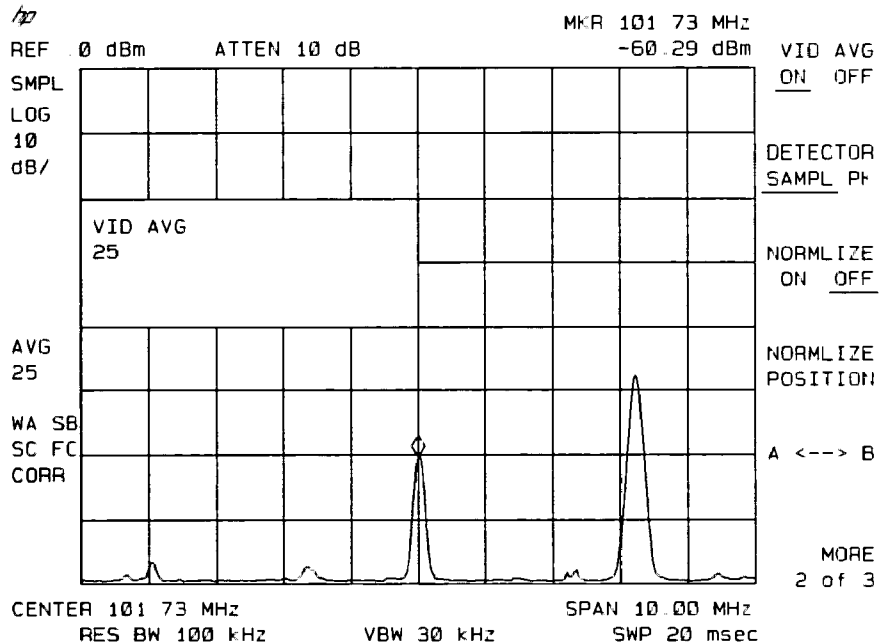

**Figure 6-20. Using the Video Averaging Function**

Once the set number of sweeps has been completed, the analyzer continues to provide a running average based on this set number.

# Identifying Distortion Products Using the RF Attenuator and Traces

## Distortion from the Analyzer

High-level input signals may cause spectrum analyzer distortion products which could mask the real distortion measured on the input signal. Using trace B and the RF attenuator, you can determine which signals, if any, are internally generated distortion products.

### Example:

1. Connect a signal generator to the analyzer input connector on the spectrum analyzer. Set the frequency of the signal to 200 MHz and set the amplitude to 0 dBm.

Set the center frequency of the spectrum analyzer to 400 MHz and set the span to 500 MHz. The signal shown in Figure 6-21 produces harmonic distortion products in the analyzer's input mixer.

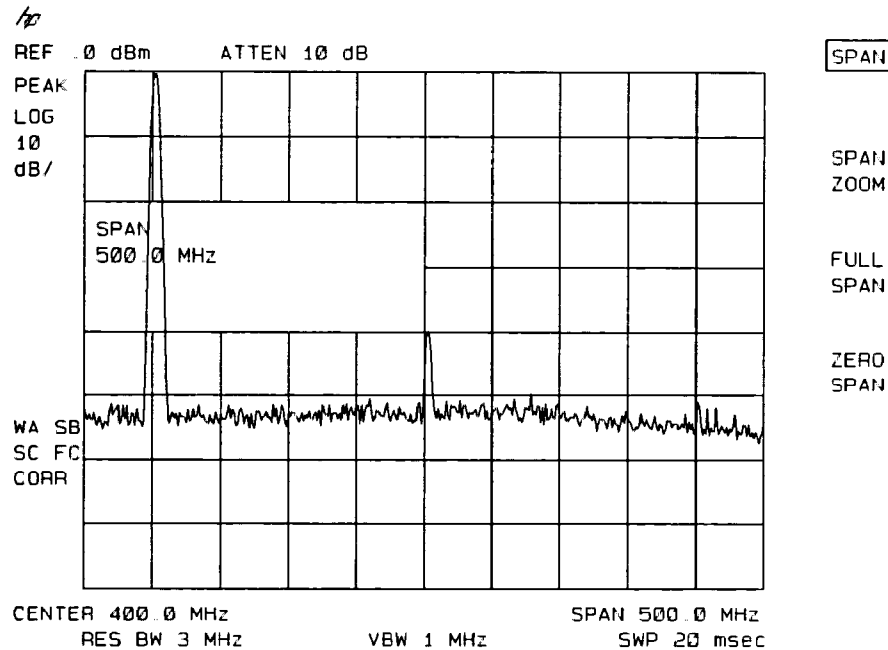
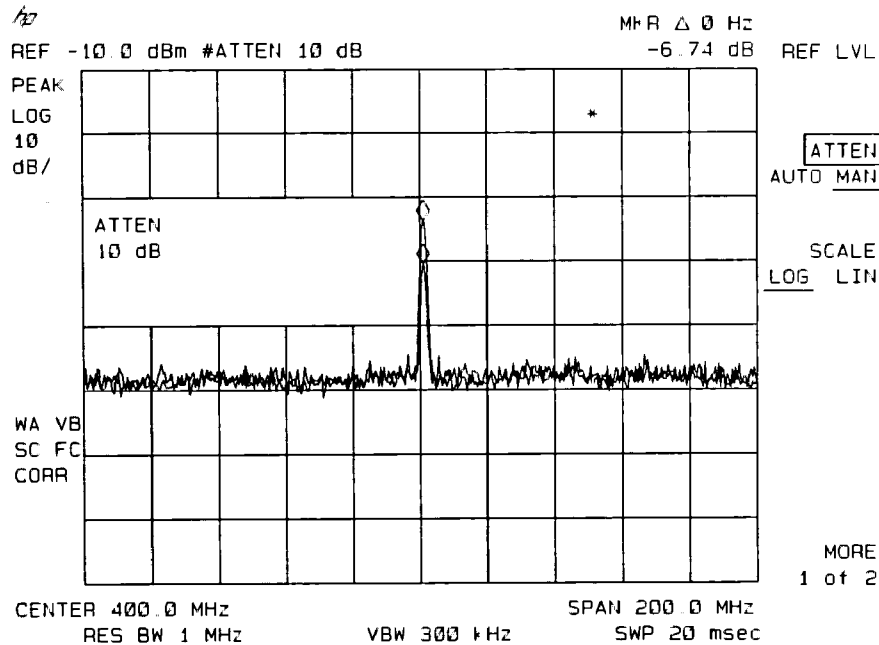

Figure 6-21. Harmonic Distortion

2. Change the span to 200 MHz. Press **SPAN**, 200 **MHz**.
3. Change the attenuation to 0 dB, press **AMPLITUDE**, **ATTEN AUTO MAN**, 0 **dBm**.
4. To determine whether the harmonic distortion products are generated by the analyzer, first save the screen data in trace B.

Press **TRACE**, **TRACE A B C** (select trace B), **CLEAR WRITE B**. Allow the trace to update (two sweeps) and press **VIEW B**, **PEAK SEARCH**, **MARKER DELTA**. The analyzer shows the stored data in trace B and the measured data in trace A on the display.

5. Next, increase the RF attenuation by 10 dB, press **AMPLITUDE**, **ATTEN AUTO MAN**, and the step up key (**▲**) once. (See Figure 6-22.)

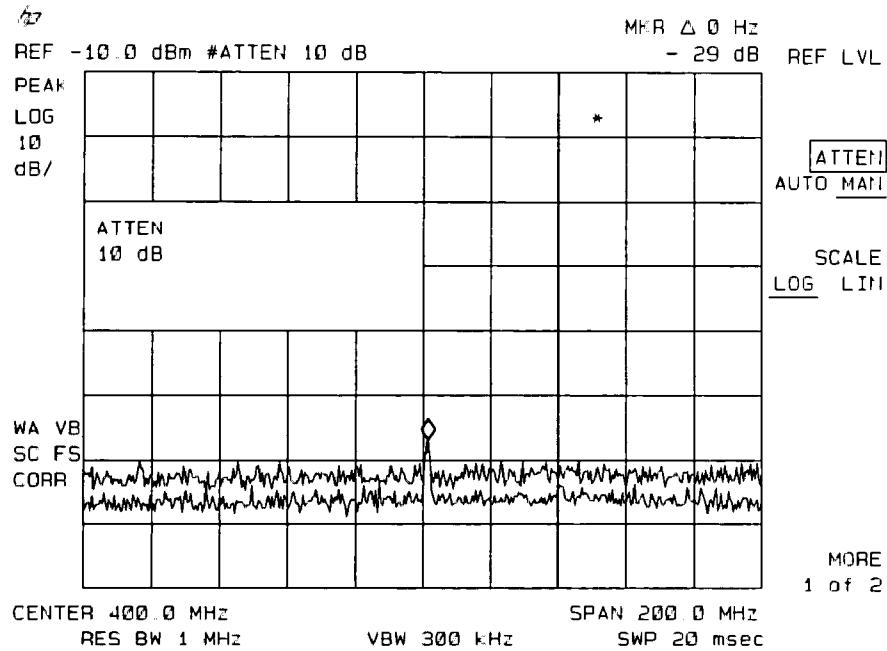

**Figure 6-22. RF Attenuation of 10 dB**

6. Compare the response in trace A to the response in trace B. If the distortion product decreases as the attenuation increases, distortion products are caused by the analyzer's input mixer.

This is shown by the marker delta value. The high-level signals causing the overload conditions must be attenuated to eliminate the interference caused by the internal distortion.

If the responses in trace A and trace B differ, as in Figure 6-22, attenuation is required. If the distortion was not caused internally, there would be no change in the signal level. For example, the signal amplitude in Figure 6-23 is not high enough to cause internal distortion in the analyzer.



**Figure 6-23. No Harmonic Distortion**

### Third-Order Intermodulation Distortion

Two-tone, third-order intermodulation is a common problem in communication systems. When two signals are present in a system, they can mix with the second harmonics generated and create third-order intermodulation distortion products, which are located close to the original signals. These distortion products are generated by system components such as amplifiers and mixers.

**Example:** Test a device for third-order intermodulation. This example uses two sources set to 300 and approximately 301 MHz. (Other source frequencies may be substituted, but try to maintain a frequency separation of approximately 1 MHz.)

1. Connect the equipment as shown in Figure 6-24.

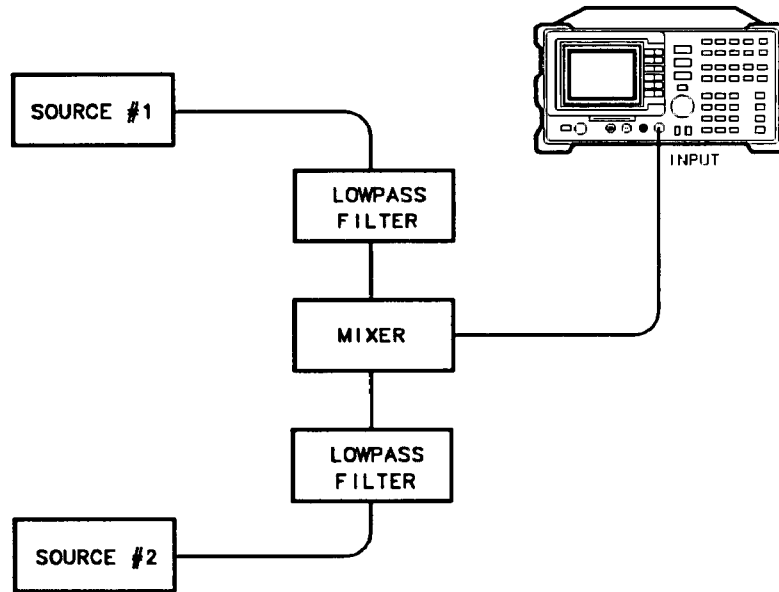

**Figure 6-24. Third-Order Intermodulation Equipment Setup**

2. Set one source to 300 MHz and the other source to 301 MHz for a frequency separation of 1 MHz. Set the sources equal in amplitude (in this example, the sources are set to  $-5$  dBm).
3. Tune both signals onto the screen by setting the center frequency between 300 and 301 MHz. Then, using the knob, center the two signals on the display. Reduce the frequency span to 5 MHz for a span wide enough to include the distortion products on the screen. To be sure the distortion products are resolved, reduce the resolution bandwidth until the distortion products are visible. Press **(BW)**, **RES BW**, and then use the step down key to reduce the resolution bandwidth until the distortion products are visible.
4. For best dynamic range, set the mixer input level to  $-40$  dBm and move the signal to the reference level: press **(AMPLITUDE)**, **MORE 1 of 2**, **MAX MXR LEVEL**, **40 (-dBm)**.

The analyzer automatically sets the attenuation so that a signal at the reference level will be a maximum of  $-40$  dBm at the input mixer.

5. To measure a distortion product, press **(PEAK SEARCH)** to place a marker on a source signal. To activate the second marker, press **MARKER DELTA**. Using the knob, adjust the second marker to the peak of the distortion product that is beside the test tone. The difference between the markers is displayed in the active function block.

To measure the other distortion product, press **(PEAK SEARCH)**, **NEXT PEAK**. This places a marker on the next highest peak, which, in this case, is the other source signal.

To measure the difference between this test tone and the second distortion product, press **MARKER DELTA** and, using the knob, adjust the second marker to the peak of the second distortion product. (See Figure 6-25.)



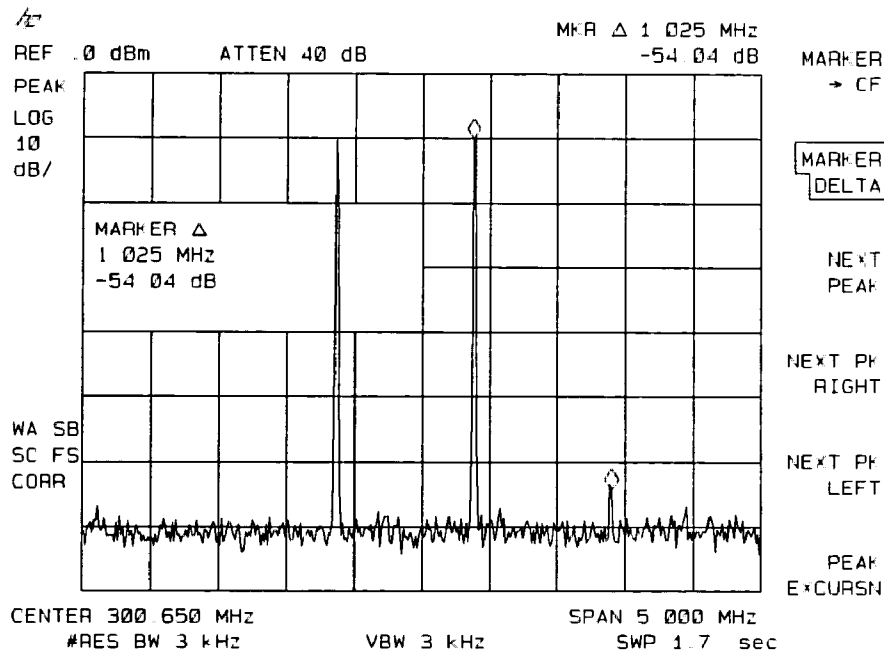

**Figure 6-25. Measuring the Distortion Product**

## Using the Analyzer As a Receiver in Zero Frequency Span

The spectrum analyzer operates as a fixed-tuned receiver in zero span. The zero span mode can be used to recover modulation on a carrier signal.

Center frequency in the swept-tuned mode becomes the tuned frequency in zero span. The horizontal axis of the screen becomes calibrated in time. Markers display amplitude and time values.

The following functions establish a clear display of the video waveform:

**TRIGGER** stabilizes the waveform trace on the display by triggering on the modulation envelope. If the signal's modulation is stable, **VIDEO TRIGGER** synchronizes the sweep with the demodulated waveform.

**LINEAR** mode should be used in amplitude modulation (AM) measurements to avoid distortion caused by the logarithmic amplifier when demodulating signals.

**SWEEP TIME** adjusts the full sweep time from 20 ms (20  $\mu$ s in zero span with Option 101), to 100 s. The sweep time readout refers to the full 10-division graticule. Divide this value by 10 to determine sweep time per division.

**RESOLUTION** and **VIDEO BANDWIDTH** are selected according to the signal bandwidth.

Each of the coupled function values remains at its current value when zero span is activated. Video bandwidth is coupled to resolution bandwidth. Sweep time is not coupled to any other function.

**Example:** View the modulation waveform of an AM signal in the time domain.

1. To obtain an AM signal, you can connect an antenna to the analyzer input and tune to a commercial AM broadcast station, or you can connect a source to the analyzer input and set the percent modulation of the source. (A headset can be used with the VIDEO OUT connector, and the spectrum analyzer will operate as a radio.)
2. First, center and zoom in on the signal in the frequency domain. (See “Decreasing the Frequency Span Using the Signal Track Function.”) Be sure to turn off the signal track function, since the signal track function must be off for zero span. See Figure 6-26.

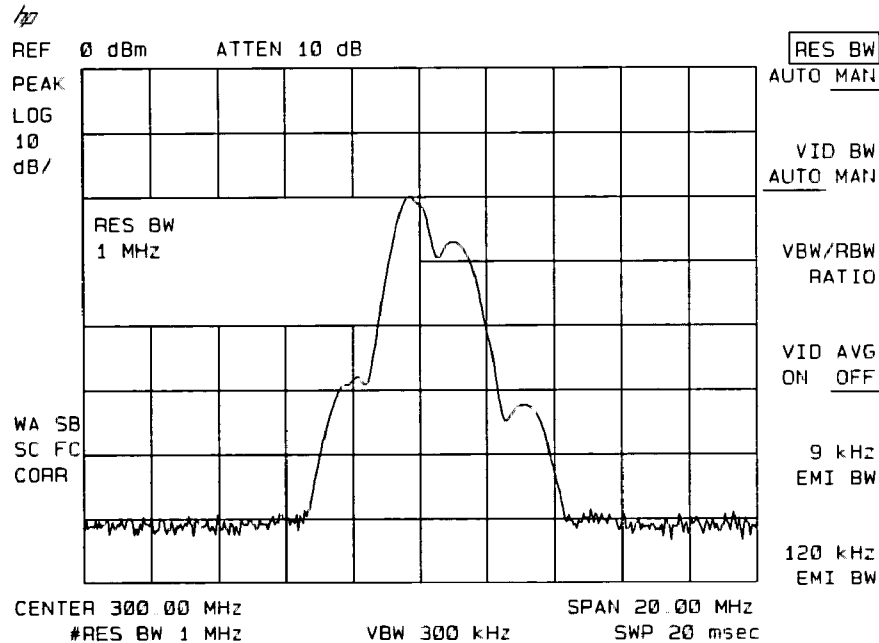

**Figure 6-26. Viewing an AM Signal**

3. To demodulate the AM, press **[BW]**. Increase the resolution bandwidth to include both sidebands of the signal within the passband of the spectrum analyzer.
4. Next, position the signal peak near the reference level and select a linear voltage display. Press **[AMPLITUDE]** and change the reference level, then press **SCALE LOG LIN** to underline LIN.
5. To select zero span, press **[SPAN]**, **0 [Hz]** or **ZERO SPAN**. See Figure 6-27. If the modulation is a steady tone (for example, from a signal generator), use video trigger to trigger on the waveform and stabilize the display. Adjust the sweep time to change the horizontal scale.

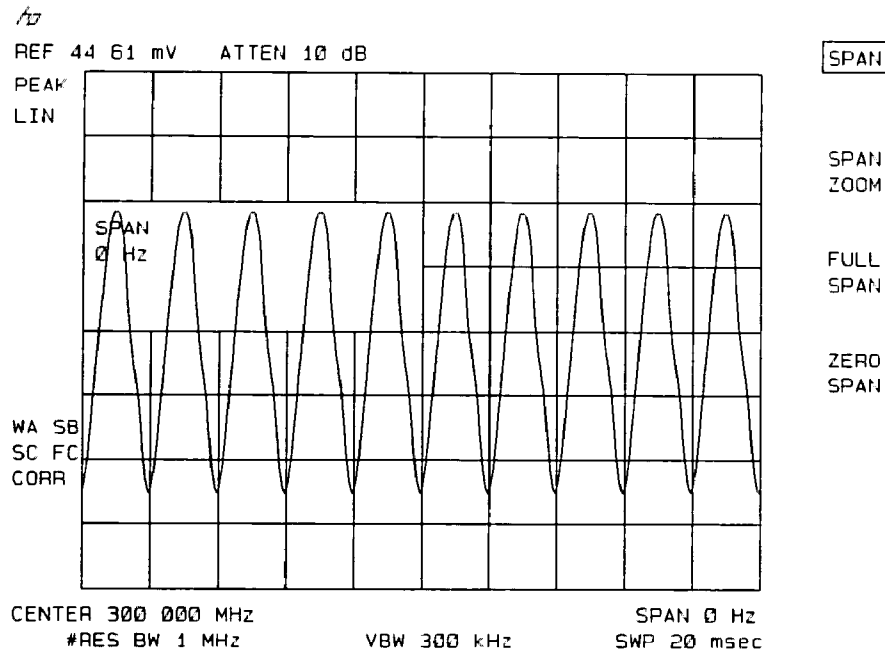

**Figure 6-27. Measuring Modulation In Zero Span**

Use markers and delta to measure time parameters of the waveform.

## Measuring Amplitude Modulation with the Fast Fourier Transform Function

The fast Fourier transform (FFT) function of the spectrum analyzer allows measurements of amplitude modulation (AM). FFT transforms demodulated AM data from the time domain (zero span) to the frequency domain. The FFT function calculates the magnitude of each frequency component from a block of time-domain samples of the input signal. It is commonly used to measure AM at rates that cannot be measured in the normal frequency domain. The FFT is a post-detection fast Fourier transform function and cannot be used to resolve continuous wave or carrier signals.

The FFT function requires a specific analyzer configuration. First, an AM signal is demodulated in the time domain. In order to do this, the resolution bandwidth is widened to include the signal sidebands within the passband of the spectrum analyzer. Next, zero span is selected so that the spectrum analyzer operates as a fixed-tuned receiver. Tuning is centered about the AM carrier.

When **MEAS/USER**, **FFT MEAS** is pressed, the function sets sample-detection mode and takes a sweep to obtain a sample of the input signal. Then the spectrum analyzer executes a series of computations on the time data to produce the frequency-domain results.

---

**Note**

After the FFT function is used, the markers are still in FFT mode for use in evaluating data. Turn off the markers before attempting to use markers in the normal fashion.

---

**Example:** Measure the sidebands on a signal using the fast Fourier transform function.

1. Connect a signal generator to the analyzer input on the front panel of the spectrum analyzer. Adjust the signal generator to produce an AM signal. (For example, set the modulation rate to 60 Hz.)
2. Center the signal on the frequency scale of the analyzer screen. For the HP 8593A, decrease the span to 200 kHz.
3. Press **BW**, 3 **kHz**. The resolution bandwidth should be about 10 times greater than the highest modulation frequency of interest. (In this case, the fourth harmonic of 60 Hz is 240 Hz.)
4. Press **VID BW AUTO MAN**, 1 **kHz**. The video bandwidth should be about two times greater than the highest modulation frequency of interest. If the video bandwidth is too large, "alias" signals may appear in the FFT if signals above the highest modulation frequency of interest are present.
5. Change the amplitude scale to linear by pressing **AMPLITUDE**, **SCALE LOG LIN** so that **LIN** is underlined.
6. Change the reference level to place the signal peak within the top two divisions of the screen by pressing **REF LVL** and turning the knob. The signal must be below the reference level.

Press **SPAN**, 0 **Hz**. The spectrum analyzer now operates as a fixed-tuned receiver.

7. See Figure 6-28, which shows maximum modulation frequency ( $f_m$ ) in Hz versus sweep time ( $T_s$ ) in seconds. Set the sweep time less than  $T_s(\text{max})$  for that maximum modulation frequency ( $f_m$ ) including the harmonics of the signal. The upper curve relates the sweep time to the maximum modulation frequency that can be observed (that is, the modulation frequency represented by the right edge of the graticule). The lower curve represents the modulation frequency one division from the left side of the graticule.

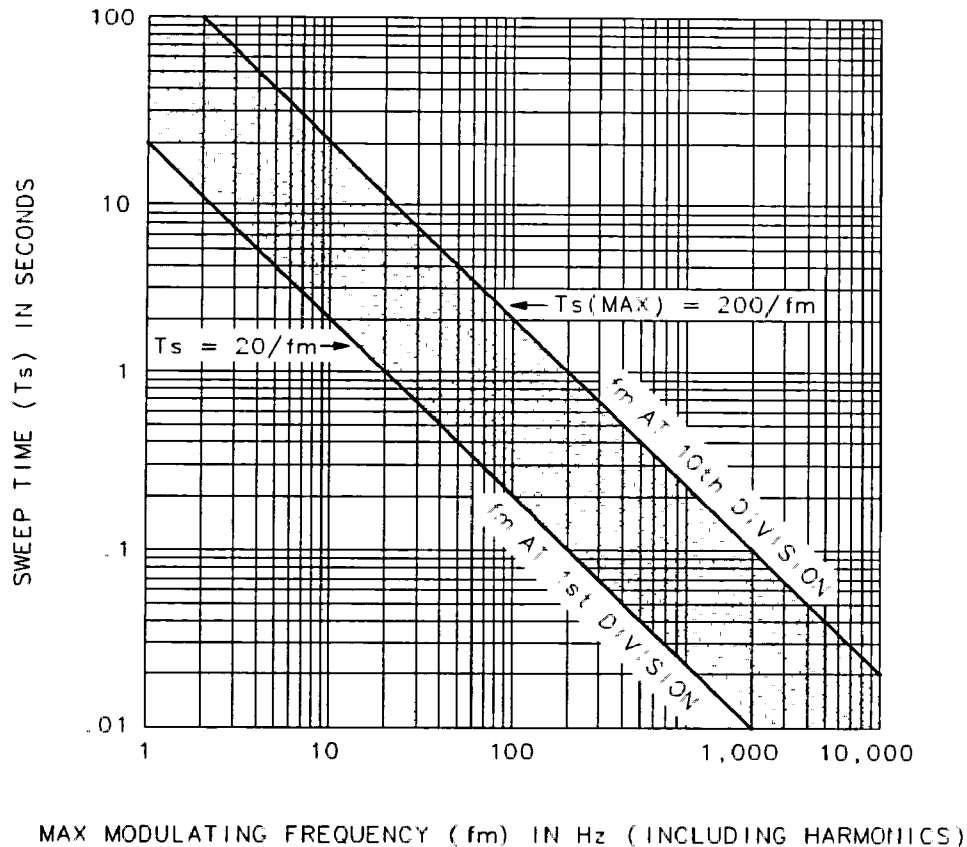

**Figure 6-28. Maximum Modulation Frequency versus Sweep Time**

Set the sweep time to fall in the shaded area between the two lines and closer to the lower line to avoid the effects of aliasing. Note that the upper line (marked fm AT 10th DIVISION) represents sampling at exactly the Nyquist rate, and some aliasing may be seen when a value for sweep time is close to the upper line. (Frequencies greater than the maximum modulation frequency for a specific sweep time will not be displayed accurately.) Press **[SWEEP]** to set the sweep time according to the figure. (For a right edge graticule limit of 250 Hz, use 800 ms.)

8. Press **[SAVE]**, INTRNL CRD (INTRNL should be underlined), STATE -> INTRNL, then 2 to save the current analyzer settings in instrument state 2. If the measurement is repeated later, retrieve the analyzer settings with **[RECALL]**, INTRNL -> STATE, 2.

**Note**



If you want to prevent the analyzer from taking a sweep before executing the FFT function, place trace A in the view mode.

9. Press **[MEAS/USER]** and **FFT MEAS**. The spectrum analyzer performs a fast Fourier transform. The frequency-domain data appears on the screen.

10. A marker is automatically placed on the carrier at the 0 Hz reference (at the left edge of the graticule). Press **MARKER DELTA** and turn the knob to the modulation to determine the frequency and amplitude difference from the carrier. See Figure 6-29.

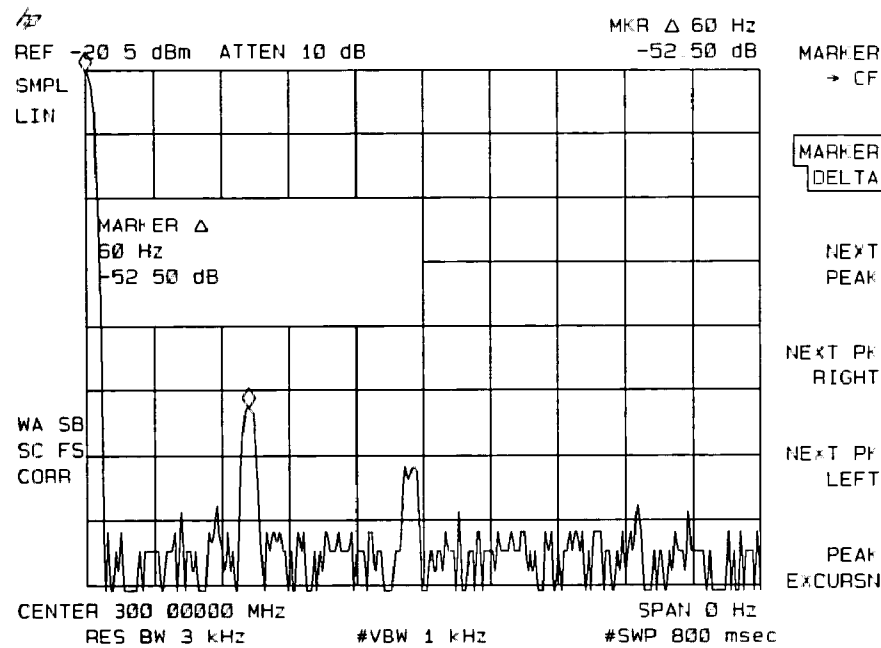

**Figure 6-29. Using the FFT Function**

The results of the FFT function are displayed on the analyzer screen. The carrier appears at the left edge of the graticule with the modulation sidebands, and any distortion appearing along the horizontal graticule. The left edge of the graticule represents 0 Hz relative to the carrier. The right edge represents the maximum FFT frequency calculated, which is 200 divided by the sweep time, or 250 Hz in Figure 6-29. The amplitude relationships among the carrier, sidebands, and distortion components are the same as they would be if the components were displayed with swept-tuned operation in log mode, 10 dB per division.

**Note**



The graticule annotation describes the settings before the FFT (linear mode, center frequency 300 MHz, span 0 Hz), and the marker annotation describes the settings after the FFT (log mode, signal at 60 Hz, maximum frequency is 250 Hz).

11. Press **(MKR)**, **MARKERS OFF** to turn off markers before proceeding with other tests.

**Note**



If the markers are not turned off after using **FFT MEAS**, they will not work as expected in other settings.

- To repeat the test, you must first clear the screen data by pressing **TRACE**, **CLEAR WRITE A**. Recall the instrument state by pressing **RECALL**, **INTRNL -> STATE**, 2. Then repeat step 9.

---

## Measuring Signals Near Band Boundaries with Harmonic Lock (HP 8593A Only)

When measuring signals at or near a band crossing, use the lowest band having a specified upper frequency limit that will include the signal of interest. See Table 1-3 for harmonic band specifications. Using harmonic lock, and choosing the lowest possible band to analyze a signal, guarantees the best specified measurement accuracy.

To lock onto a specific harmonic, press **SPAN**, **BAND LOCK**, **BND LOCK ON OFF** (ON should be underlined), or select a band (see Table 1-3 in Chapter 1 for band specifications). After setting the harmonic lock, only center frequencies and spans within the frequency band of the harmonic may be entered. The span is automatically reduced to accommodate a center frequency specified near the end of the band range.

### Example:

- Connect 100 MHz COMB OUT to the analyzer input.

- Press the following keys:

**PRESET** **AUX CTRL** **COMB GEN ON OFF** (ON should be underlined) **FREQUENCY** 12.9 **GHz**.

Press **SPAN**, 350 **MHz**, **BAND LOCK**, **BND LOCK ON OFF** (turn the harmonic lock on).

- Place a marker on the leftmost peak by using the **PEAK SEARCH** keys.
- Press **MARKER DELTA**, **NEXT PK RIGHT**, **NEXT PK RIGHT** to show the frequency and amplitude difference between the two comb teeth.

You will see three comb teeth on your display. The analyzer is locked in band 3 and will not allow multiband sweeps. See Figure 6-30.

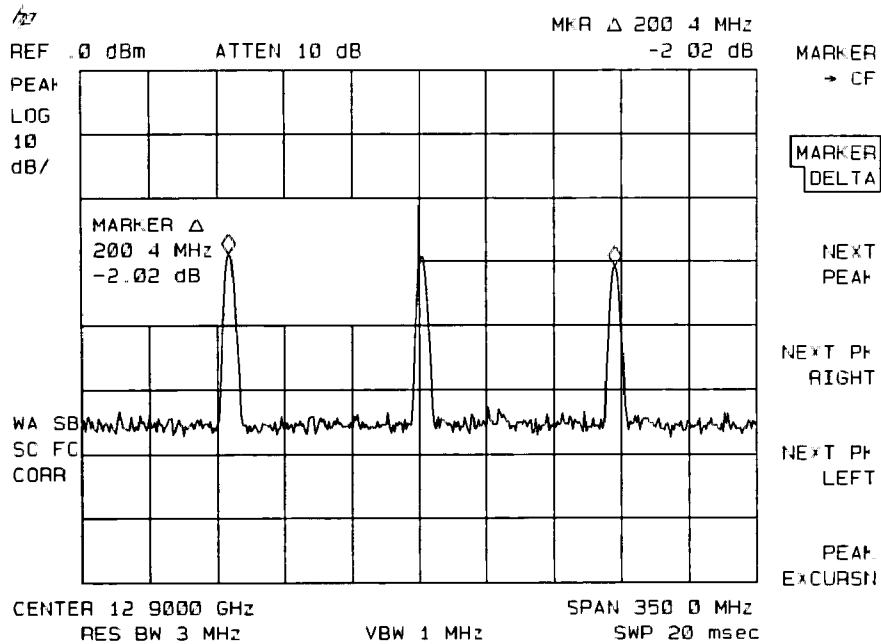

**Figure 6-30. Using Harmonic Lock**

To see a multiband sweep, press the following keys:

**MR**, **MARKERS OFF**, **SPAN**, **BAND LOCK**, **BND LOCK ON OFF** (OFF should be underlined).

Place a marker on the leftmost peak.

Press **MARKER DELTA**. Use **NEXT PK RIGHT** to place a marker on the rightmost peak. The marker readout displays the frequency and amplitude difference between the two comb teeth. See Figure 6-31.



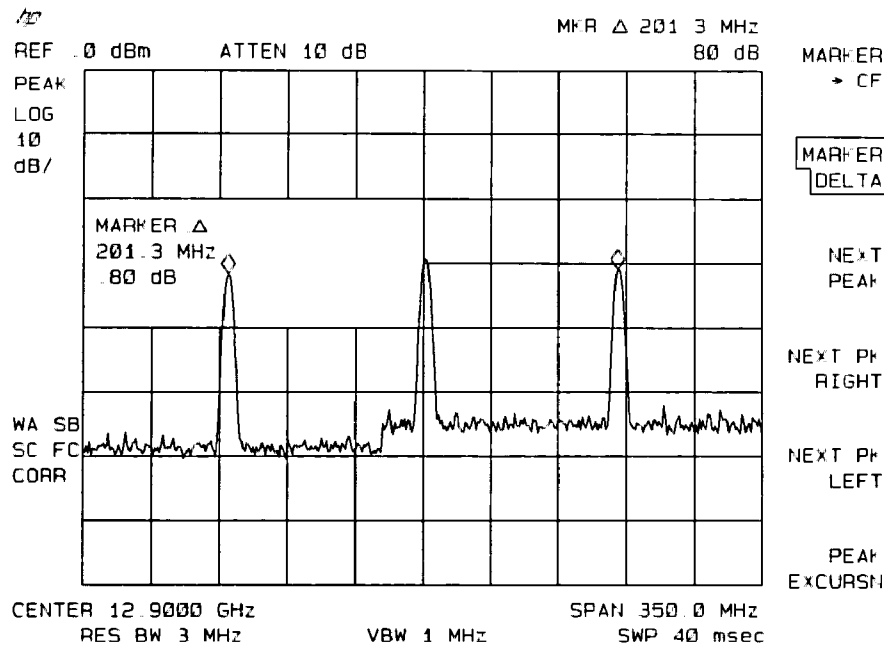

**Figure 6-31. Harmonic Locking Off**

**Note**

The comb frequencies have a 100 MHz spacing.



## Stimulus-Response Measurements (HP 8591A with Option 010 or 011 Only)

### What Are Stimulus-Response Measurements?

Stimulus-response measurements require a source to stimulate a device under test (DUT), a receiver to analyze the frequency-response characteristics of the DUT, and, for return-loss measurements, a directional coupler. Characterization of a DUT can be made in terms of its transmission or reflection parameters. Examples of transmission measurements include flatness and rejection. A reflection measurement is return loss.

A spectrum analyzer combined with a tracking generator forms a stimulus-response measurement system. With the tracking generator as the swept source and the spectrum analyzer as the receiver, operation is analogous to a single-channel scalar network analyzer. Being a narrow-band system results in a wide dynamic measurement range, but the tracking generator's output frequency must be made to precisely track the spectrum analyzer's input frequency. This wide dynamic range will be illustrated in the following example. Figure 6-32 shows the block diagram of a spectrum-analyzer/tracking-generator system.

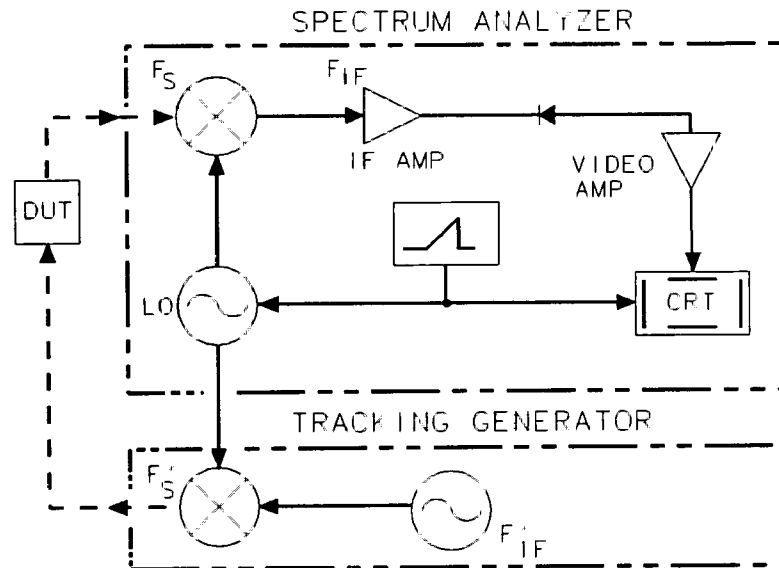

**Figure 6-32. Block Diagram of a Spectrum-Analyzer/Tracking-Generator Measurement System**

### Spectrum Analyzer Functions Used

The procedure below describes how to use the HP 8591A Option 010 Spectrum Analyzer with built-in tracking generator system to measure the rejection of a low-pass filter, which is a type of transmission measurement. Illustrated in this example are the functions in the tracking-generator menu, such as adjusting the tracking-generator output power, source calibration, and normalization. Conducting a reflection measurement is similar and will not be covered. Refer to the HP Spectrum Analyzer Seminar, or Application Note 150-7, for more information.

### Stepping Through the Measurement

There are four basic steps in performing a stimulus-response measurement, whether it be a transmission or reflection measurement: set up the spectrum analyzer settings, calibrate, normalize, and measure.

1. If necessary, perform the self-calibration routine for the tracking generator described in "Performing the Tracking Generator Self-Calibration Routine" in Chapter 5.
2. To measure the rejection of a low-pass filter, connect the equipment as shown in Figure 6-33. This example uses a filter with a cut-off frequency of 300 MHz as the DUT.

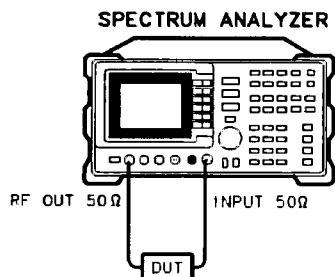

**Figure 6-33. Transmission Measurement Test Setup**

3. Activate the tracking generator menu by pressing **AUX CTRL**, **TRACK GEN**. To activate the tracking-generator power level, press **SRC PWR ON OFF** until ON is underlined. See Figure 6-34.

**Caution**



Excessive signal input may damage the DUT. Do not exceed the maximum power that the device under test can tolerate.

**Note**



To reduce ripples caused by source return loss, use 10 dB or greater tracking generator output attenuation. Tracking generator output attenuation is normally a function of the source power selected. However, it may be controlled by **SRC ATN MAN**. Refer to Table 1-2 for more information on the relationship between source power and source attenuation.

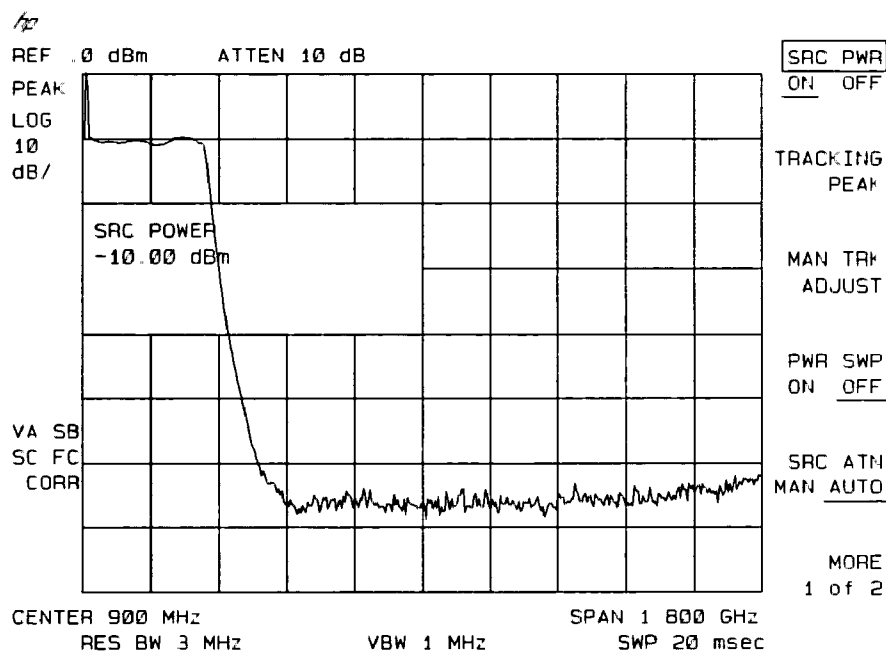

**Figure 6-34. Tracking-Generator Output Power Activated**

- Put the sweep time of the analyzer into stimulus-response auto-coupled mode by pressing **MORE 1 OF 2**, then **SWP CPLG SR SA** until **SR** is underlined. In stimulus-response mode, the auto-coupled sweep times are usually much faster for swept-response measurements.

**Note**



In the stimulus-response mode, the Q (reactance versus resistance) of the DUT can determine the fastest rate at which the analyzer can be swept. To determine if the analyzer is sweeping too fast, slow the sweep time and note whether there is a frequency or amplitude shift of the trace. Continue to slow the sweep time until there is no longer a frequency or amplitude shift.

- Since we are only interested in the rejection of the low-pass filter, tune the spectrum analyzer's center frequency so that the rolloff of the filter comprises the majority of the trace on the display (see Figure 6-35).

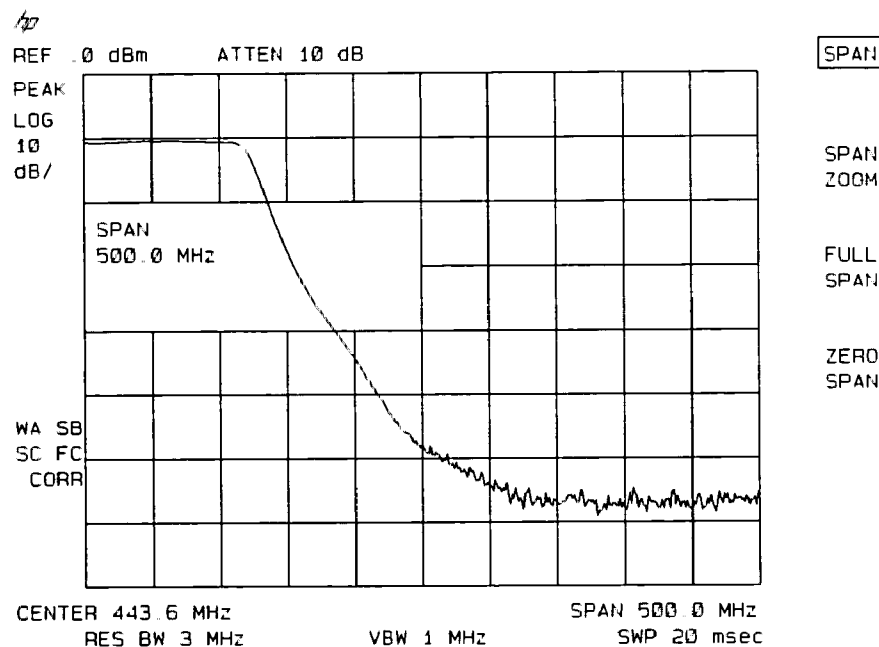

**Figure 6-35. Spectrum Analyzer Settings According to the Measurement Requirement**

- Decrease the resolution bandwidth to increase sensitivity, and narrow the video bandwidth to smooth the noise. In Figure 6-36, the resolution bandwidth has been decreased to 10 kHz.

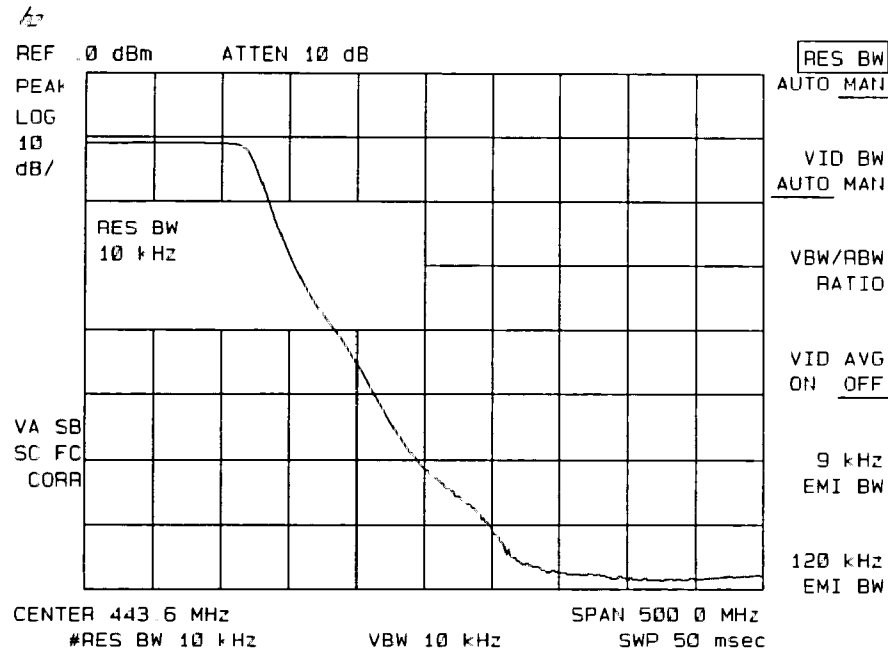

**Figure 6-36. Decrease the Resolution Bandwidth to Improve Sensitivity**

Adjusting the resolution bandwidth may result in a decrease in amplitude of the signal. This is known as a tracking error. Tracking errors occur when the tracking generator's output frequency is not exactly matched to the input frequency of the spectrum analyzer (the input to the spectrum analyzer is not at the center of the resolution bandwidth filter). Tracking errors are most notable when using narrow resolution bandwidths. Tracking error can be compensated manually or automatically. In narrow bandwidths, the manual method of adjusting the tracking is usually faster than the automatic tracking adjustment. To compensate for the tracking error manually, press **AUX CTRL**, **TRACK GEN**, **MAN TRK ADJUST**, then use the knob to adjust the trace for the highest amplitude. To compensate for the tracking error automatically, press **AUX CTRL**, **TRACK GEN**, **TRACKING PEAK**.

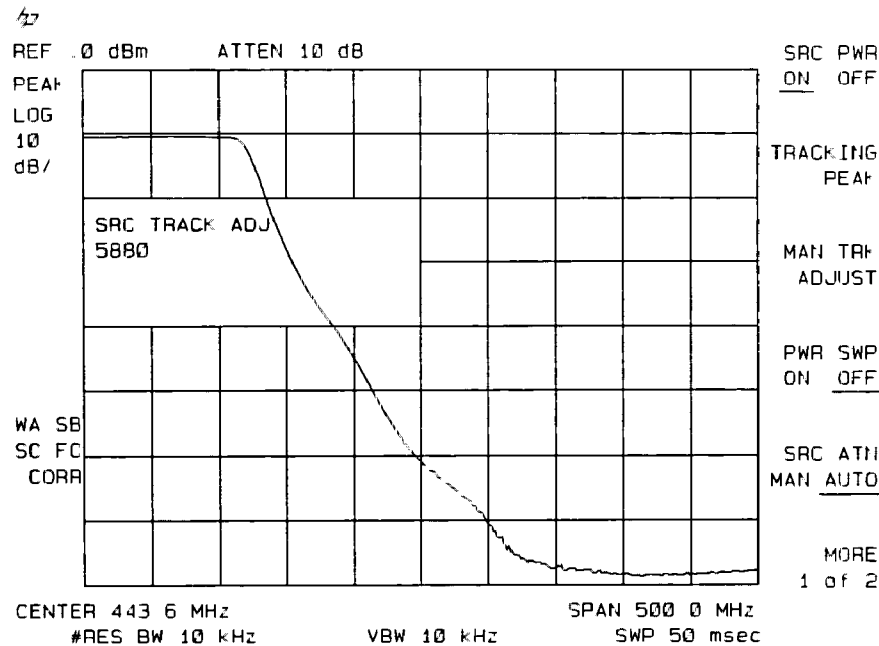

**Figure 6-37. Manual Tracking Adjustment Compensates for Tracking Error**

**Note**



If the automatic tracking routine is activated in a narrow resolution bandwidth, it usually is not necessary to use the tracking adjust again when increasing the resolution bandwidth.

7. To make a transmission measurement accurately, the frequency response of the test system must be known. To measure the frequency response of the test system, connect the cable (but not the DUT) from the tracking generator output to the analyzer input. Press **TRACE**, **TRACE A B C** (so B is underlined), **CLEAR WRITE B**, **BLANK B**. The frequency response of the test system is now stored in trace B.
8. Normalization eliminates the frequency response error of the test system. When normalization is on, trace math is being performed on the active trace. The trace math performed is trace A minus trace B plus the display line, with the result placed into trace A. Remember that trace A contained the measurement trace, trace B contained the stored calibration trace, and DL represents the normalized reference position. Note that the units of the reference level, dB, reflect this relative measurement.

To normalize, reconnect the DUT to the analyzer. Press **TRACE**, **MORE 1 of 3**, **NORMLIZE ON OFF** until ON is underlined. Press **NORMLIZE POSITION** to activate the display line. This display line marks the normalized reference position, or the position where 0 dB insertion loss (transmission measurements) or 0 dB return loss (reflection measurements) will normally reside. Using the knob results in a change in the position of the normalized trace, within the range of the graticule.

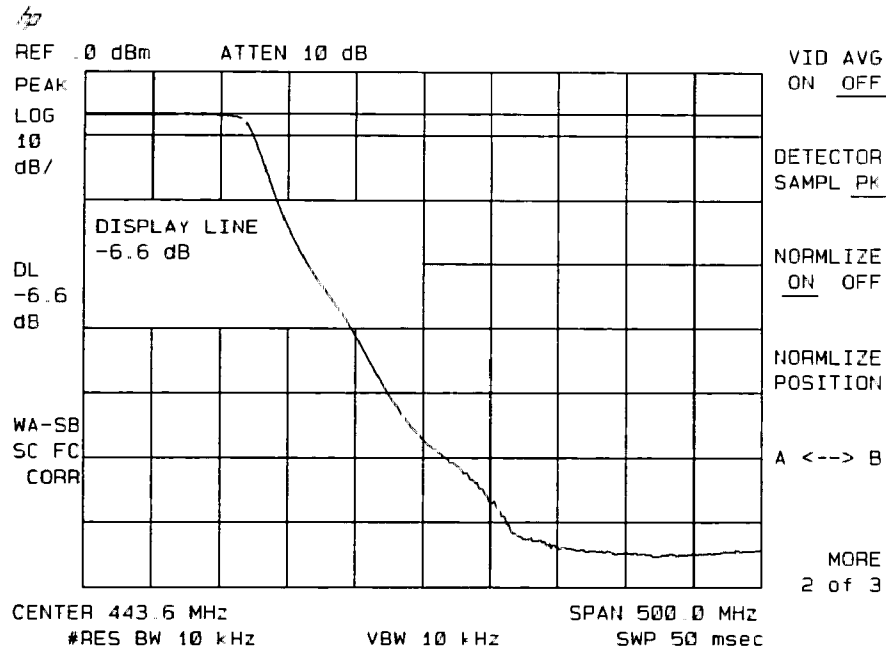

**Figure 6-38. Normalized Trace**

- To measure the rejection of the filter at a given frequency, press **(MKR)**, and enter the frequency. For example, enter 350 MHz. The marker readout displays the rejection of the filter at 350 MHz (see Figure 6-39).

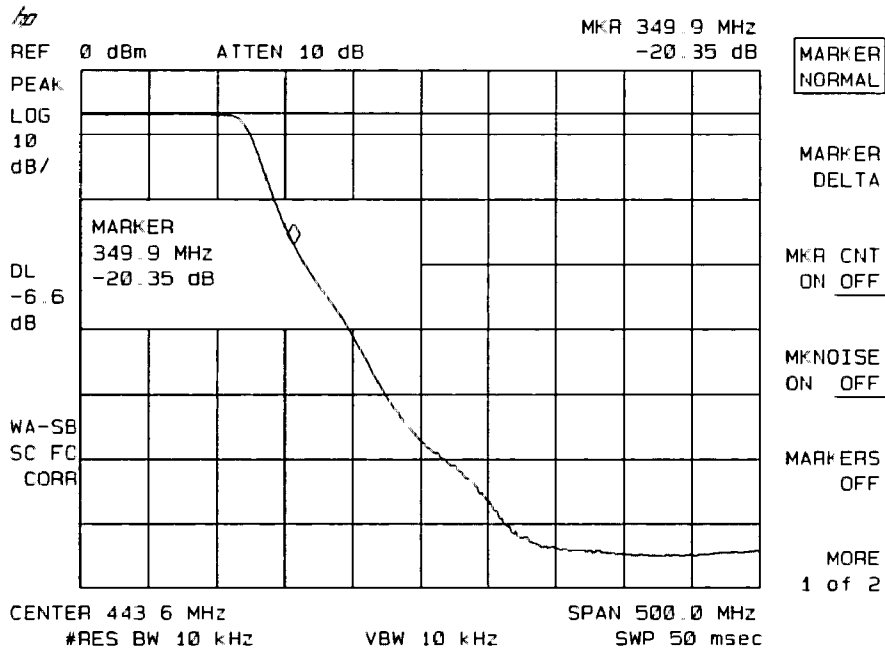

**Figure 6-39. Measure the Rejection Range with Delta Markers**

When using the tracking generator, the message **TG UNLVL** may appear. The **TG UNLVL** message indicates that the tracking generator source power (**SRC PWR ON OFF**) could not be maintained at the user-selected level during some portion of the sweep. If the unlevel condition exists at the beginning of the sweep, the message will be displayed immediately. If the unlevel condition occurs after the sweep begins, the message will be displayed after the sweep is completed. A momentary unlevel condition may not be detected when the sweep time is small. The message will be cleared after a sweep is completed with no unlevel conditions.

The unlevel condition may be caused by any of the following:

- Start frequency is too low or the stop frequency is too high. The unlevel condition is likely to occur if the true frequency range exceeds the tracking generator frequency specification (especially the low frequency specification). The true frequency range being swept may be significantly different than the start or stop frequency annotations indicate, depending on other settings of the analyzer, especially the span (see Table 1-1.) For better frequency accuracy, use a narrower span.
- Tracking peak may be required (use **TRACKING PEAK**).
- Source attenuation may be set incorrectly (select **SRC ATN MAN AUTO (AUTO)** for optimum setting).
- The source power (**SRC PWR ON OFF**) may be set too high or too low.

---

## Demodulating and Listening to an AM or FM Signal (Option 102 only)

The functions listed in the menu under **DEMOD** allow you to demodulate and hear signal information displayed on the spectrum analyzer. Simply place a marker on a signal of interest, activate AM or FM demodulation, and then listen.

### Example:

1. Connect an antenna to the analyzer input.
2. Select a frequency range on the analyzer, such as the range for FM radio broadcasts. For example, the frequency range for FM broadcasts in the United States is 88 MHz to 108 MHz. Press **PRESET**, **FREQUENCY**, **START FREQ**, 88 **MHz**, **STOP FREQ**, 108 **MHz**.
3. Place a marker on the signal of interest by using **PEAK SEARCH** to place a marker on the highest-amplitude signal, or pressing **MKR**, **MARKER NORMAL** to move the marker to a signal of interest.
4. Press **AUX CTRL**, **DEMOD**, **DEMOD ON OFF** (so that **ON** is underlined), and **DEMOD AM FM** (so that **FM** is underlined). The **SPEAKER ON OFF** function is set to **ON PRESET**. Use the front-panel volume control to control the speaker's volume.



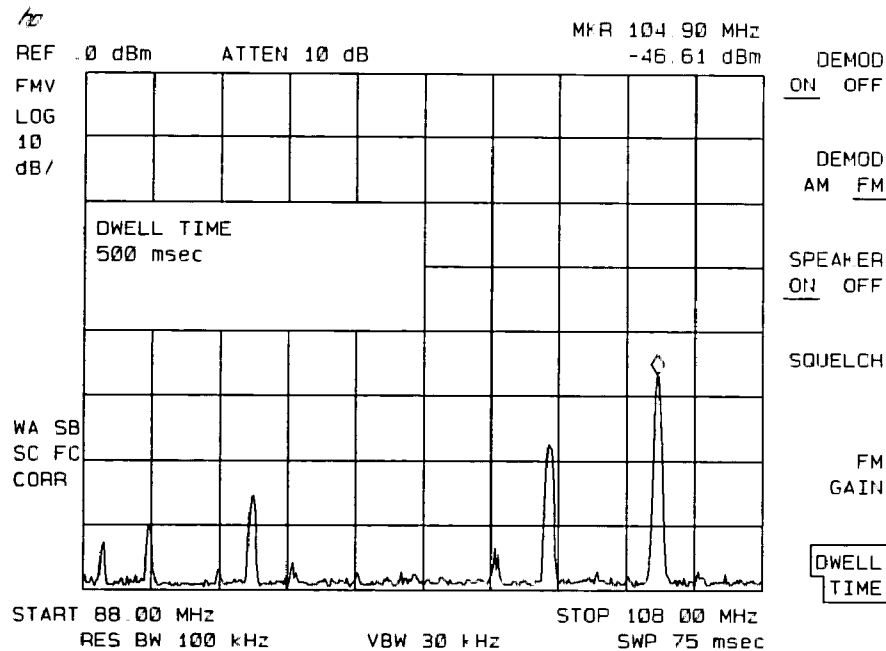
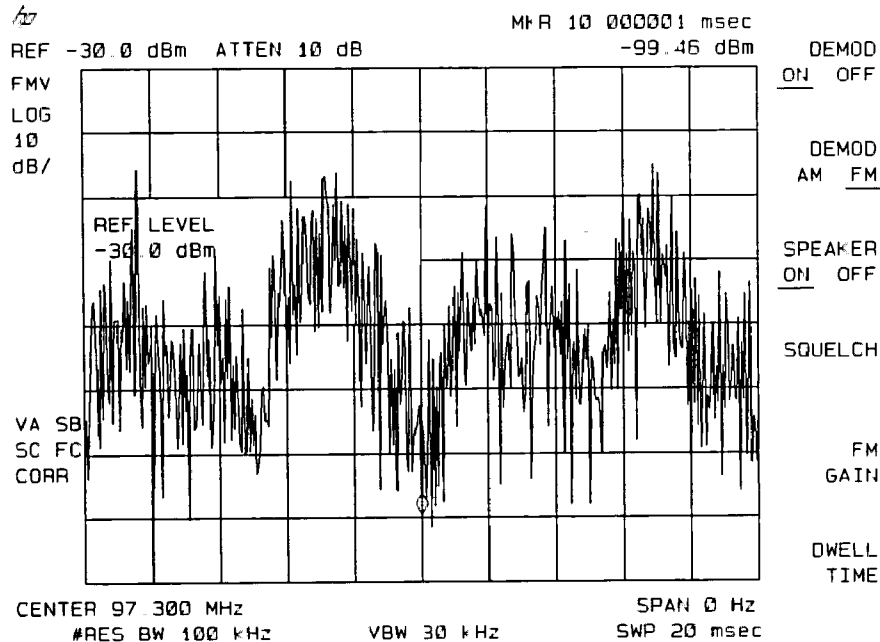

**Figure 6-40. Demodulation of an FM Signal**

5. The signal is demodulated at the marker's position for the duration of the dwell time. Use the step keys, knob, or number/units keypad to change the dwell time. For example, press the step up key (**▲**) twice to increase the dwell time to 2 seconds.
6. The **PEAK SEARCH** functions can be used to move the marker to other signals of interest. Press **PEAK SEARCH** to access **NEXT PEAK**, **NEXT PK RIGHT**, or **NEXT PK LEFT**.

**Example:** The signal can be continuously demodulated if the analyzer is in zero span.

1. Place the marker on a signal of interest as in steps 1 through 3 of the previous example.
2. If the signal of interest is the highest-amplitude on-screen signal, set the frequency of the signal to center frequency with the **SIGNAL TRACK**. If it is not the highest-amplitude on-screen signal, move the signal to center screen with **MKR ->**, **MARKER -> CF**.
3. Press **SPAN**, **1 MHz** to reduce the span to 1 MHz if signal track is on. If signal track is not used, use the step down key (**▼**) to reduce the span and use **MARKER -> CF** to keep the signal of interest at center screen.
4. Set the span to zero by pressing **ZERO SPAN**. (**ZERO SPAN** turns off the signal track function.)
5. Change the resolution bandwidth to 100 kHz. Press **BW**, **100 kHz**.
6. Set the signal in the top two divisions of the screen by changing the reference level. Press **AMPLITUDE**, and use the step down key (**▼**) until the signal is in the top two divisions.
7. Press **AUX CTRL**, **DEMOD**, **DEMOD ON OFF** (so that ON is underlined), **DEMOD AM FM** (so that FM is underlined). The **SPEAKER ON OFF** function is set to ON by the PRESET function. Use the front-panel volume control to control the speaker's volume.



**Figure 6-41. Continuous Demodulation of an FM Signal**

For FM demodulation, **FM GAIN** adjusts the top-to-bottom screen deviation of the signal, using center screen as a reference. FM gain sensitivity is increased by decreasing the FM gain value. As the FM gain sensitivity is increased, the volume is increased. **SQUELCH** mutes the noise level.

### Triggering on a Selected Line of a Video Picture Field (Options 101 and 102 Only)

With Options 101 and 102, you can trigger on a TV picture carrier signal. This example enables you to view a test signal transmitted during vertical retrace when the TV screen is blanked.

1. Press **PRESET**.
2. Set the frequency of a picture carrier signal to center frequency.
3. Press **TRIG**, **TV TRIG**. If in a nonzero span, **TV TRIG** sets the amplitude scale to linear, places a marker on the signal peak, moves the marker to the reference level, changes the detector to sample, sets the sweep time to 100  $\mu$ s, sets the resolution bandwidth to 1 MHz, and sets the span to 0 Hz. The TV line number is the active function. The **PRESET** function sets the analyzer to trigger on an odd field of a video format and TV line number 17.

The sweep time of 100  $\mu$ s allows you to view two TV lines, line 17 and part of line 18.

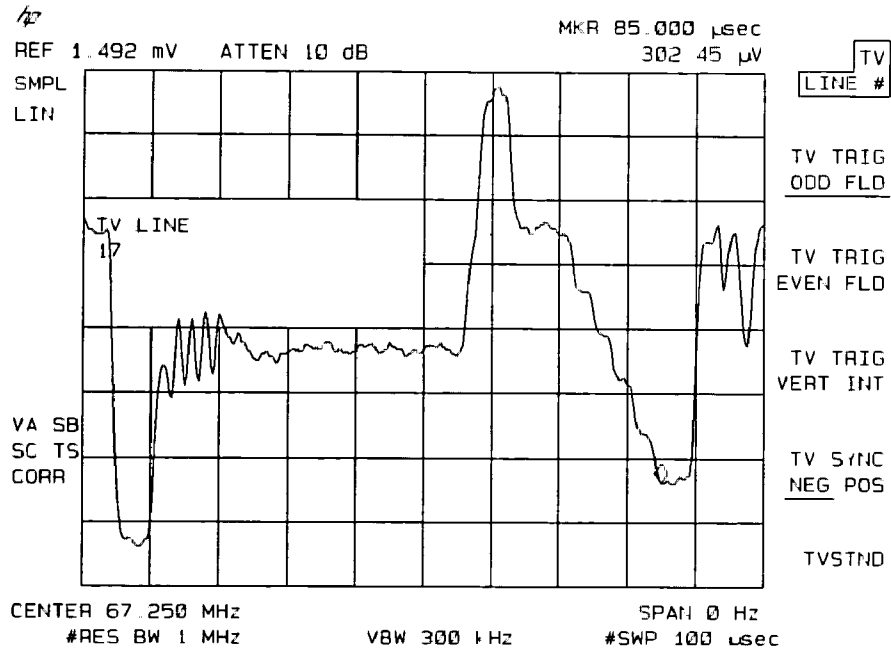

**Figure 6-42. Triggering on an Odd Field of a Video Format**

The multiburst is on TV line number 17, and the composite is on TV line number 18.

4. Press **TV TRIG EVEN FLD** to trigger on an even field of a video format.

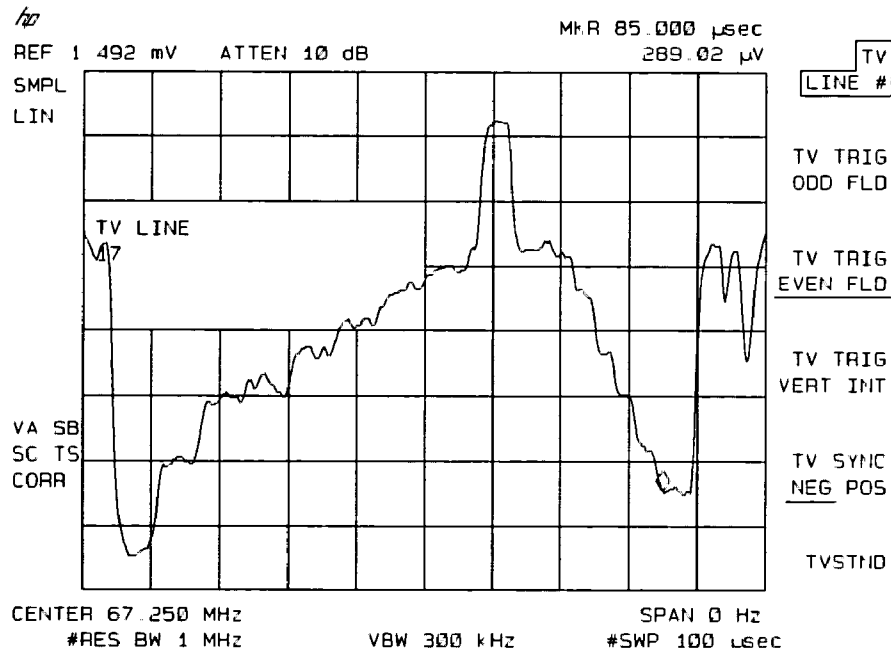

**Figure 6-43. Triggering on an Even Field of a Video Format**

The default video format is NTSC. Press **TVSTND**, then **PAL-M**, **PAL**, or **SECAM-L** to select a different video format. For noninterlaced video formats, press **TV TRIG VERT INT**.

---

**Note**



The selection of video format (**NTSC**, **PAL-M**, **PAL**, or **SECAM-L**) automatically selects the video modulation (negative or positive).

---



## Analyzer Functions

---

### What You'll Learn in This Chapter

This chapter describes functions, controls, and connectors of the spectrum analyzer. The front-panel keys and softkey functions are listed alphabetically (except for the service diagnostic functions which are listed after Table 7-1). Use Table 7-1 to find the page number of the function's description. Table 7-1 is divided into the functional blocks of the analyzer:

- Amplitude.
- Control.
- Copy.
- Frequency.
- Instrument state.
- Marker.
- Span.

The controls and connectors are covered at the end of the chapter:

- Data controls.
- Front-panel controls and fine focus control.
- Front-panel and rear-panel connectors.

---

**Note**

All analyzer functions are listed in the index at the end of this manual. In addition, all softkeys are shown in the menu diagram inside the rear cover of this manual.

---

Table 7-1. Index of Analyzer Functions

Function Block	Front-panel and Softkey Functions	Option Required	Front-panel key access	Page
AMPLITUDE	AMPLITUDE		AMPLITUDE	7-12
	AMPTD UNITS		AMPLITUDE	7-13
	ATTEN AUTO MAN		AMPLITUDE	7-13
	dBm		AMPLITUDE	7-25
	dBmV		AMPLITUDE	7-25
	dBuV		AMPLITUDE	7-25
	EXT PREAMP		AMPLITUDE	7-29
	INPUT Z 50 75		AMPLITUDE	7-31
	MAX MXR LEVEL		AMPLITUDE	7-34
	PRESEL DEFAULT		AMPLITUDE	7-37
	PRESEL PEAK		AMPLITUDE	7-37
	REF LVL		AMPLITUDE	7-42
	REF LVL OFFSET		AMPLITUDE	7-42
	SCALE LOG LIN		AMPLITUDE	7-43
	Volts		AMPLITUDE	7-51
Watts		AMPLITUDE	7-51	
CONTROL	9 kHz EMI BW		BW	7-11
	120 kHz EMI BW		BW	7-11
	A <--> B		TRACE	7-11
	A - B -> A ON OFF		TRACE	7-11
	ABCDE F		DISPLAY, CONFIG, or MEAS/USER	7-12
	A -> C		TRACE	7-12
	ANNOTATN ON OFF		DISPLAY	7-13
	ATTEN AUTO MAN		AMPLITUDE or AUTO COUPLE	7-13
	AUTO ALL		AUTO COUPLE	7-13
	AUTO COUPLE			7-13
	B -> C		TRACE	7-14
	B <--> C		TRACE	7-14
	B - DL -> B		TRACE	7-14
	BLANK A		TRACE	7-15
	BLANK B		TRACE	7-15
	BLANK C		TRACE	7-15
	BW			7-15
	CF STEP AUTO MAN		FREQUENCY or AUTO COUPLE	7-21
	CHANGE PREFIX		DISPLAY or CONFIG	7-21
	CHANGE TITLE		DISPLAY or MEAS/USER	7-21
	CLEAR		DISPLAY, CONFIG, or MEAS/USER	7-22
	CLEAR WRITE A		TRACE	7-22
	CLEAR WRITE B		TRACE	7-22
	CLEAR WRITE C		TRACE	7-22

Table 7-1. Index of Analyzer Functions (continued)

Function Block	Front-panel and Softkey Functions	Option Required	Front-panel key access	Page
CONTROL	DETECTOR SAMPL PK		TRACE	7-27
	DISPLAY			7-27
	DSP LINE ON OFF		DISPLAY	7-28
	EXTERNAL		TRIG	7-29
	FREE RUN		TRIG	7-30
	GHIJKL		DISPLAY, CONFIG, or MEAS/USER	7-31
	GRAT ON OFF		DISPLAY	7-31
	LINE		TRIG	7-32
	MAX HOLD A		TRACE	7-34
	MAX HOLD B		TRACE	7-34
	MIN HOLD C		TRACE	7-34
	MNOPQR		DISPLAY, CONFIG, or MEAS/USER	7-35
	NORMLIZE ON OFF		TRACE	7-35
	NORMLIZE POSITION		TRACE	7-36
	NTSC	101 and 102	TRIG	7-36
	PAL	101 and 102	TRIG	7-36
	PAL-M	101 and 102	TRIG	7-36
	RES BW AUTO MAN		BW or AUTO COUPLE	7-42
	RPG TITLE		DISPLAY or MEAS/USER	7-42
	SECAM-L	101 and 102	TRIG	7-44
	STUVWX		DISPLAY, CONFIG, or MEAS/USER	7-47
	SWEEP			7-47
	SWEEP CONT SGL		SWEEP or TRIG	7-47
	SWP TIME AUTO MAN		SWEEP or AUTO COUPLE	7-47
	THRESHLD ON OFF		DISPLAY	7-48
	TRACE			7-48
	TRACE A B C		TRACE	7-48
	TRIG			7-49
	TV LINE #	101 and 102	TRIG	7-49
	TVSTND	101 and 102	TRIG	7-49
	TV SYNC NEG POS	101 and 102	TRIG	7-49
	TV TRIG	101 and 102	TRIG	7-50
	TV TRIG EVEN FLD	101 and 102	TRIG	7-50
	TV TRIG ODD FLD	101 and 102	TRIG	7-50
	TV TRIG VERT INT	101 and 102	TRIG	7-50
	VBW/RBW RATIO		BW	7-50
	VID AVG ON OFF		TRACE	7-50
	VID BW AUTO MAN		BW or AUTO COUPLE	7-50
	VIDEO		TRIG	7-51
	VIEW A		TRACE	7-51



Table 7-1. Index of Analyzer Functions (continued)

Function Block	Front-panel and Softkey Functions	Option Required	Front-panel key access	Page
CONTROL	VIEW B		<b>TRACE</b>	7-51
	VIEW C		<b>TRACE</b>	7-51
	YZ_#SPC CLEAR		<b>DISPLAY</b> , <b>CONFIG</b> , or <b>MEAS/USER</b>	7-51
COPY	<b>COPY</b>	021 or 023		7-23
FREQUENCY	CENTER FREQ		<b>FREQUENCY</b>	7-21
	CF STEP AUTO MAN		<b>FREQUENCY</b>	7-21
	FREQ OFFSET		<b>FREQUENCY</b>	7-30
	<b>FREQUENCY</b>			7-30
	START FREQ		<b>FREQUENCY</b>	7-46
	STOP FREQ		<b>FREQUENCY</b>	7-47
INSTRUMENT STATE	% AM		<b>MEAS/USER</b>	7-11
	3 dB POINTS		<b>MEAS/USER</b>	7-11
	3rd ORD MEAS		<b>MEAS/USER</b>	7-11
	6 dB POINTS		<b>MEAS/USER</b>	7-11
	99% PWR BW		<b>MEAS/USER</b>	7-11
	ABCDEF		<b>DISPLAY</b> or <b>CONFIG</b>	7-12
	ALC MTR INT XTAL		<b>AUX CTRL</b>	7-12
	ALL DLP -> CARD		<b>SAVE</b>	7-12
	AMPLTUD COR FACT		<b>SAVE</b> or <b>RECALL</b>	7-12
	ANALYZER ADDRESS	021	<b>CONFIG</b>	7-13
	AUX CONN CONTROL		<b>AUX CTRL</b>	7-14
	<b>AUX CTRL</b>			7-14
	B & W PRINTER	021 or 023	<b>CONFIG</b>	7-14
	BAUD RATE	023	<b>CONFIG</b>	7-14
	BLANK CARD		<b>CONFIG</b>	7-15
	<b>CAL</b>			7-15
	CAL AMPTD		<b>CAL</b>	7-15
	CAL FETCH		<b>CAL</b>	7-16
	CAL FREQ		<b>CAL</b>	7-16
	CAL FREQ & AMPTD		<b>CAL</b>	7-16
	CAL MXR		<b>CAL</b>	7-16
	CAL STORE		<b>CAL</b>	7-16
	CAL TIMEBASE		<b>CAL</b>	7-16
	CAL TRK GEN		<b>CAL</b>	7-16
	CAL YTF		<b>CAL</b>	7-16
	CARD CONFIG		<b>CONFIG</b>	7-16
	CARD -> DLP		<b>RECALL</b>	7-16
	CARD -> STATE		<b>RECALL</b>	7-16
	CARD -> TRACE		<b>RECALL</b>	7-17
	CATALOG ALL		<b>SAVE</b> or <b>RECALL</b>	7-17

Table 7-1. Index of Analyzer Functions (continued)

Function Block	Front-panel and Softkey Functions	Option Required	Front-panel key access	Page
INSTRUMENT STATE	CATALOG AMP CORR		SAVE or RECALL	7-17
	CATALOG CARD		SAVE or RECALL	7-17
	CATALOG DLP		SAVE or RECALL	7-19
	CATALOG INTRNL		SAVE or RECALL	7-19
	CATALOG LMT LINE		SAVE or RECALL	7-20
	CATALOG PREFIX		SAVE or RECALL	7-20
	CATALOG REGISTER		SAVE or RECALL	7-20
	CATALOG STATES		SAVE or RECALL	7-20
	CATALOG TRACES		SAVE or RECALL	7-20
	CATALOG VARIABLES		SAVE or RECALL	7-20
	CHANGE PREFIX		CONFIG or DISPLAY	7-21
	CLEAR		DISPLAY or CONFIG	7-22
	CNTL A 0 1		AUX CTRL	7-22
	CNTL B 0 1		AUX CTRL	7-22
	CNTL C 0 1		AUX CTRL	7-22
	CNTL D 0 1		AUX CTRL	7-22
	COMB GEN ON OFF		AUX CTRL	7-23
	CONFIG			7-23
	CONF TEST		CAL	7-23
	COPY DEV PRNT PLT	021 or 023	CONFIG	7-24
	CORRECT ON OFF		CAL	7-25
	CRT HORZ POSITION		CAL	7-25
	CRT VERT POSITION		CAL	7-25
	DATEMODE MDY DMY		CONFIG	7-25
	DEFAULT CAL DATA		CAL	7-25
	DEFAULT CONFIG		CONFIG	7-25
	DELETE FILE		SAVE or RECALL	7-26
	DELETE SEGMENT		MEAS/USER	7-26
	DELTA MEAS		MEAS/USER	7-26
	DEMODO	102	AUX CTRL	7-26
	DEMODO AM FM	102	AUX CTRL	7-26
	DEMODO ON OFF	102	AUX CTRL	7-27
	DISPLAY CNTL I		AUX CTRL	7-27
	DISPOSE USER MEM		CONFIG	7-27
	DWELL TIME	102	AUX CTRL	7-28
	EDIT DONE		MEAS/USER	7-28
	EDIT FLATNESS		CAL	7-28
	EDIT LIMIT		MEAS/USER	7-28
	EDIT LOWER		MEAS/USER	7-28
	EDIT MID/DELT		MEAS/USER	7-28

Table 7-1. Index of Analyzer Functions (continued)

Function Block	Front-panel and Softkey Functions	Option Required	Front-panel key access	Page
INSTRUMENT STATE	EDIT UP/LOW		MEAS/USER	7-28
	EDIT UPPER		MEAS/USER	7-29
	EDIT UPR LWR		MEAS/USER	7-29
	EXECUTE TITLE		CAL	7-29
	EXIT		CAL	7-29
	EXIT CATALOG		SAVE or RECALL	7-29
	EXIT SHOW		CONFIG	7-29
	FFT MEAS		MEAS/USER	7-29
	FLAT		MEAS/USER	7-30
	FLATNESS DATA		CAL	7-30
	FM GAIN	102	AUX CTRL	7-30
	FORMAT CARD		CONFIG	7-30
	GHIJKL		DISPLAY or CONFIG	7-31
	INTRNL CRD		SAVE or RECALL	7-31
	INTRNL -> STATE		RECALL	7-31
	INTRNL -> TRACE		RECALL	7-31
	LIMIT LINES		MEAS/USER	7-31
	LIMITS FIX REL		MEAS/USER	7-31
	LIMITS ON OFF		MEAS/USER	7-32
	LOAD FILE		SAVE or RECALL	7-32
	MAN TRK ADJUST	010 or 011	AUX CTRL	7-33
	MEAS/USER			7-34
	MNOPQR		DISPLAY or CONFIG	7-35
	MODE			7-35
	NEW LIMIT		MEAS/USER	7-35
	NO USER MENU		MEAS/USER	7-36
	PAINTJET PRINTER	021 or 023	CONFIG	7-36
	PK-PK MEAS		MEAS/USER	7-37
	PLOT CONFIG	021 or 023	CONFIG	7-37
	PLOTTER ADDRESS	021 or 023	CONFIG	7-37
	PLT _ _ LOC _ _	021 or 023	CONFIG	7-37
	PLTS/PG 1 2 4	021 or 023	CONFIG	7-37
	POINT		MEAS/USER	7-37
	PRESET			7-38
	PRESET SPECTRUM		MODE or PRESET	7-39
	PRINT CONFIG	021 or 023	CONFIG	7-40
	PRINTER ADDRESS	021 or 023	CONFIG	7-40
	PRINTER SETUP	021 or 023	CONFIG	7-40
	PRT MENU ON OFF	021 or 023	CONFIG	7-40

Table 7-1. Index of Analyzer Functions (continued)

Function Block	Front-panel and Softkey Functions	Option Required	Front-panel key access	Page
INSTRUMENT STATE	PURGE LIMITS		MEAS/USER	7-41
	PWR SWP ON OFF		AUX CTRL	7-41
	RECALL			7-41
	RECALL LIMIT		MEAS/USER	7-41
	RPG TITLE		DISPLAY or MEAS/USER	7-42
	SAVE			7-42
	SAVE LIMIT		MEAS/USER	7-43
	SAV LOCK ON OFF		SAVE	7-43
	SELECT AMPLITUD		MEAS/USER	7-44
	SELECT DLT AMPL		MEAS/USER	7-44
	SELECT FREQ		MEAS/USER	7-44
	SELECT LWR AMPL		MEAS/USER	7-44
	SELECT MID AMPL		MEAS/USER	7-44
	SELECT SEGMENT		MEAS/USER	7-44
	SELECT TYPE		MEAS/USER	7-44
	SELECT UPR AMPL		MEAS/USER	7-44
	SERVICE CAL		CAL	7-45
	SET ATTN ERROR		CAL	7-45
	SET DATE		CONFIG	7-45
	SET TIME		CONFIG	7-45
	SGL SWP			7-45
	SHOW OPTIONS		CONFIG	7-45
	SIGNAL TRACK			7-45
	SLOPE		MEAS/USER	7-45
	SPEAKER ON OFF	102	AUX CTRL	7-46
	SPECTRUM ANALYZER		MODE or PRESET	7-46
	SQUELCH	102	AUX CTRL	7-46
	SRC ATN ON OFF	010 or 011	AUX CTRL	7-46
	SRC PWR OFFSET	010 or 011	AUX CTRL	7-46
	SRC PWR ON OFF	010 or 011	AUX CTRL	7-46
	SRC PWR STP SIZE	010 or 011	AUX CTRL	7-46
	STATE -> CARD		SAVE	7-47
	STATE -> INTRNL		SAVE	7-47
	STUVWX		DISPLAY or CONFIG	7-47
	SWP CPLG SR SA	010 or 011	AUX CTRL	7-47
	TIMEDATE		CONFIG	7-48
	TIMEDATE ON OFF		CONFIG	7-48
	TRACE A		SAVE or RECALL	7-48
	TRACE B		SAVE or RECALL	7-48
	TRACE C		SAVE or RECALL	7-48
TRACE -> CARD		SAVE	7-48	

Table 7-1. Index of Analyzer Functions (continued)

Function Block	Front-panel and Softkey Functions	Option Required	Front-panel key access	Page
INSTRUMENT STATE	TRACE -> INTRNL		<b>SAVE</b>	7-49
	TRACK GEN	010 or 011	<b>AUX CTRL</b>	7-49
	TRACKING PEAK	010 or 011	<b>AUX CTRL</b>	7-49
	USER MENU(S)		<b>MEAS/USER</b>	7-50
	VERIFY TIMEBASE		<b>CAL</b>	7-50
	YZ_#SPC CLEAR		<b>DISPLAY</b> or <b>CONFIG</b>	7-51
MARKER	CNT RES AUTO MAN		<b>MKR</b>	7-22
	MARKER AMPTD		<b>MKR</b>	7-33
	MARKER -> CF		<b>MKR -&gt;</b> or <b>PEAK SEARCH</b>	7-33
	MARKER -> CF STEP		<b>MKR -&gt;</b>	7-33
	MARKER DELTA		<b>MKR</b> or <b>PEAK SEARCH</b>	7-33
	MARKER NORMAL		<b>MKR</b>	7-33
	MARKER -> REF LVL		<b>MKR -&gt;</b>	7-34
	MARKERS OFF		<b>MKR</b>	7-34
	MINIMUM -> MARKER		<b>MKR -&gt;</b>	7-34
	MKNOISE ON OFF		<b>MKR</b>	7-34
	MKPAUSE ON OFF		<b>MKR</b>	7-34
	<b>MKR</b>			7-34
	<b>MKR -&gt;</b>			7-34
	MKR CNT ON OFF		<b>MKR</b>	7-35
	MKR Δ -> SPAN		<b>MKR -&gt;</b>	7-35
	NEXT PEAK		<b>PEAK SEARCH</b> or <b>MKR -&gt;</b>	7-35
	NEXT PK LEFT		<b>PEAK SEARCH</b> or <b>MKR -&gt;</b>	7-35
	NEXT PK RIGHT		<b>PEAK SEARCH</b> or <b>MKR -&gt;</b>	7-35
	PEAK EXCURSN		<b>PEAK SEARCH</b> or <b>MKR -&gt;</b>	7-36
	PEAK MENU		<b>MKR -&gt;</b>	7-37
	<b>PEAK SEARCH</b>			7-37
	PK-PK MEAS		<b>MKR</b>	7-37
	<b>SIGNAL TRACK</b>			7-45
SPAN	0-2.9 Gz BAND 0		<b>SPAN</b>	7-11
	2.75-6.4 BAND 1		<b>SPAN</b>	7-11
	6.0-12.8 BAND 2		<b>SPAN</b>	7-11
	12.4-19. BAND 3		<b>SPAN</b>	7-11
	19.1-22 BAND 4		<b>SPAN</b>	7-11
	BAND LOCK		<b>SPAN</b>	7-14
	BND LOCK ON OFF		<b>SPAN</b>	7-15
	FULL SPAN		<b>SPAN</b>	7-30
	SPAN		<b>SPAN</b>	7-45

**Table 7-1. Index of Analyzer Functions (continued)**

Function Block	Front-panel and Softkey Functions	Option Required	Front-panel key access	Page
SPAN	SPAN			7-45
	SPAN ZOOM		SPAN	7-46
	ZERO SPAN		SPAN	7-51

The service diagnostic functions are designed for service use only. Descriptions of the service diagnostic functions are available in the service documentation. You can order the service documentation, HP 8591A Option 915 or HP 8593A Option 915, through your HP Sales and Service office. The package is described under "Service Documentation for the HP 8591A (Option 915)" or "Service Documentation for the HP 8593A (Option 915)" in Chapter 1 of this manual.

SERVICE DIAG access the following service diagnostic routines:

DISPLAY CAL DATA

DACS

STP GAIN ZERO

AUX A

AUX B (for the HP 8591A only)

2v REF DETECTOR

GND REF DETECTOR

MAIN COIL DR

FM COIL DRIVE

FM SPAN

MAIN SPAN

SWEEP RAMP

SWEEP TIME DAC

COARSE TUNE DAC

BINARY SPAN (HP 8591A only)

YTF SPAN (HP 8593A only)

FINE TUNE DAC

X FINE TUNE DAC

+10V REF DETECTOR

-10V REF DETECTOR

DROOP

FREQ DIAG

SETPLL OUTDAC

FRQ DISC NORM OFF

FM GAIN (Option 102 only)

FM OFFST (Option 102 only)

YTF TUNE COARSE (HP 8593A only)

YTF TUNE FINE (HP 8593A only)

YTF DRIVER (HP 8593A only)

MIXER BIAS (HP 8593A only)

PRESEL DAC (HP 8593A only)

ALC TEST (HP 8591A with Option 010 or 011 only).

---

## Analyzer Functions

<b>% AM</b>	determines the percent of amplitude modulation of a signal with amplitude modulation only. <b>% AM</b> finds the amplitude difference between the two highest peaks on the screen and computes the percent modulation for the calculated dB difference.
<b>0-2.9 Gz BAND 0</b>	is available for HP 8593A only. It locks onto harmonic band 0. Harmonic band 0 uses low-pass filtering instead of bandpass preselection. It has a specified tuning range of 0 to 2.9 GHz.
<b>2.75-6.4 BAND 1</b>	is available for HP 8593A only. It locks onto harmonic band 1. Harmonic band 1 is preselected and has a specified tuning range of 2.75 to 6.4 GHz.
<b>3 dB POINTS</b>	automatically places two markers at points 3 dB from the highest point on the highest on-screen signal, and determines the frequency differences between the two markers. Thus, the 3 dB bandwidth of a signal is determined. The amplitude scale must be logarithmic.
<b>3rd ORD MEAS</b>	finds the third-order product and measures the frequency and amplitude differences relative to the fundamental signal. Three signals must be on screen. <b>3rd ORD MEAS</b> performs the following routine: <b>PEAK SEARCH</b> , <b>MARKER DELTA</b> , <b>NEXT PEAK</b> , <b>NEXT PEAK</b> .
<b>6.0-12.8 BAND 2</b>	is available for HP 8593A only. It locks onto harmonic band 2. Harmonic band 2 is preselected and has a specified tuning range of 6.0 to 12.8 GHz.
<b>6 dB POINTS</b>	automatically places two markers at points 6 dB from the highest point on the highest on-screen signal, and determines the frequency differences between the two markers. Thus, the 6 dB bandwidth of a signal is determined. The amplitude scale must be logarithmic.
<b>9 kHz EMI BW</b>	allows a 6 dB resolution bandwidth of 9 kHz. This bandwidth is useful when performing electromagnetic interference (EMI) measurements.
<b>12.4-19. BAND 3</b>	is available for HP 8593A only. It locks onto harmonic band 3. Harmonic band 3 is preselected and has a specified tuning range of 12.4 to 19.4 GHz.
<b>19.1-22 BAND 4</b>	is available for HP 8593A only. It locks onto harmonic band 4. Harmonic band 4 is preselected and has a specified tuning range of 19.1 to 22 GHz.
<b>99% PWR BW</b>	computes the power of all signal responses and returns the bandwidth under which 99% of total power is found.
<b>120 kHz EMI BW</b>	allows a 6 dB resolution bandwidth of 120 kHz. This bandwidth is useful when performing electromagnetic interference (EMI) measurements.
<b>A&lt;--&gt;B</b>	exchanges the contents of the trace A register with the trace B register and puts trace A in view mode.
<b>A - B -&gt; A ON OFF</b>	<b>A - B -&gt; A ON OFF</b> , when ON, subtracts the data in trace B from the measured data in trace A. The resulting trace (trace A) is displayed, the input minus stored data. A minus sign (-) appears between the trace A status and the trace B status in the screen annotation while the function is active.



To deactivate this function, press **A - B -> A ON OFF** so that **OFF** is underlined.

**A - B -> A ON OFF** and **B - DL -> B** are math functions. Unlike operations on dBm units, math functions operate on measurement units. Measurement units are used to format trace data for data within the graticule limits. The displayed amplitude of each element falls on one of 8000 vertical points with 8000 equal to the reference level. For log scale data, each point is equal to 0.01 dB. The peak of a signal equal to -10 dBm, or one division below the reference level, is equal to 7000 measurement units (8000 - 1000 = 7000). In linear mode, each point has a resolution of [reference level in volts/8000].

For example, if trace A contains amplitude values of -10 dBm and trace B contains amplitude values of -40 dBm, the result of the **A - B -> A** function would be -10.004 dBm if dBm units were used. Since measurement units are used for the **A - B -> A** function, the result of **A - B -> A** is -50 dBm (-10 dBm = 7000 measurement units, -40 dBm = 4000 measurement units; the result is 3000 measurement units, which is equal to -50 dBm).

**ABCDEF** accesses the softkey menu for selecting screen title characters A through F.

**A -> C** moves trace A into trace C.

**ALC MTR**  
**INT XTAL** is available for HP 8591A with Option 010 or 011 only. Automatic leveling control (ALC) activates internal (INT) leveling or external (XTAL or MTR) leveling. The external leveling input (located on the rear panel of the analyzer) can be used with a power meter or crystal, with positive or negative voltage output. See Table 1-2 for the leveling input characteristics. External leveling increases the amplitude accuracy by improving the effective source match. The meter (MTR) position narrows ALC loop bandwidth so an HP power meter can be used.

**ALL DLP**  
**-> CARD** saves all the downloadable programs and key definitions in the analyzer memory on the memory card. If the downloadable program was stored using a prefix, the file name for the downloadable program consists of d(prefix).(register number). If no prefix was specified, the data is stored with the file name d.(register number).

**AMPLITUDE** activates the reference level function and accesses the amplitude menu. The softkeys accessed by **AMPLITUDE** change reference level, input attenuation, vertical scale, mixer level, amplitude units, input impedance, and amplitude offset. For the HP 8593A, **AMPLITUDE** accesses the preselector peaking and preselector default functions also.

**AMPLTUD**  
**COR FACT** saves or recalls amplitude correction factors from analyzer memory or the memory card. Amplitude correction factors are saved with an "a" before the memory card file name. Screen titles are not recalled with the data. See "Entering Amplitude Correction Factors," "To Save a Limit-Line Table or Amplitude Correction Factors," and "To Recall a Limit-Line Table or Amplitude Correction Factors" in Chapter 5 for more information. Amplitude correction factor memory card files can be catalogued using **CATALOG AMP CORR**.

<b>AMPTD UNITS</b>	accesses the softkeys that change the amplitude units. The amplitude units can be changed by pressing <b>dBm</b> , <b>dBmV</b> , <b>dBuV</b> , <b>Volts</b> , or <b>Watts</b> .
<b>ANALYZER ADDRESS</b>	allows you to change the HP-IB address of the analyzer. The analyzer address is set to 18 by <b>DEFAULT CONFIG</b> .
<b>ANNOTATN ON OFF</b>	turns the screen annotation on and off. However, softkey annotation will remain on the screen. The annotation may not be required for prints or plots, or during remote operation.
<b>ATTEN AUTO MAN</b>	sets the input attenuation from 0 to 60 dB (for the HP 8591A) or 0 to 70 dB (for the HP 8593A), in 10 dB increments. The analyzer input attenuator, which is normally coupled (linked) to the reference level control, reduces the power level of the analyzer input signal at the input mixer. The attenuator is recoupled when <b>AUTO</b> is underlined.

---

### Caution



To prevent damage to the input mixer, the power level at the input mixer must not exceed +30 dBm. To prevent signal compression, power at the input to the input mixer must be kept below -10 dBm.

---

### Note



To protect the mixer from possible damage, 0 dB RF attenuation (no input power reduction to the mixer) can be selected only from the number/units keypad.

---

### AUTO ALL

couples the following functions: resolution bandwidth, video bandwidth, attenuation, sweep time, center frequency step, video bandwidth, and video-bandwidth/resolution-bandwidth ratio.

### **AUTO COUPLE**

accesses the softkey menu of functions that can be coupled. (Coupled functions are functions that are linked: if one function is changed, the other function is changed.)

The functions that can be auto-coupled are listed below:

- Resolution bandwidth couples to span.
- Video bandwidth couples to resolution bandwidth when using the video-bandwidth to resolution-bandwidth ratio with the video bandwidth to resolution bandwidth ratio set to 0.3.
- Sweep time couples to span, resolution bandwidth, and video bandwidth.
- RF attenuation couples to reference level.
- Center frequency step size couples to 10% of span.

During normal operation, the sweep time, resolution bandwidth, and video bandwidth are coupled to yield optimum performance. If any of these functions becomes uncoupled (that is, is manually set), a “#” will appear next to it on the screen.

If one or more function(s) is manually set so that the amplitude or frequency becomes uncalibrated, **MEAS UNCAL** appears on the right side of the graticule.

Recouple a single function by pressing the function label (to activate the function), and pressing the function again so that **AUTO** is underlined.

**AUTO COUPLE**, **AUTO ALL** couples all coupled functions listed.

**AUX CONN  
CONTROL**

accesses the softkey menu to control the auxiliary outputs and input. The auxiliary outputs are controlled by **CNTL A 0 1**, **CNTL B 0 1**, **CNTL C 0 1**, and **CNTL D 0 1**. The status of the auxiliary input (control line I), can be displayed on the analyzer screen with **DISPLAY CNTL I**.

**AUX CTRL**

accesses the menu to control demodulation parameters (if Option 102 is installed), the tracking generator (if Option 010 or 011 is installed), the auxiliary connector, and, for the HP 8593A, the comb generator.

**B & W  
PRINTER**

is available for Option 021 or 023 only. It selects a black and white print. Use this function if you have a black and white printer, or if you are using an HP PaintJet printer, but want to have a black and white print. **DEFAULT CONFIG** selects **B & W PRINTER**.

**BAND  
LOCK**

is available for the HP 8593A only. It accesses the harmonic band menu and the band lock function.

Selecting a harmonic band causes the analyzer to lock onto the specified harmonic band and automatically select the settings shown.

**Table 7-2. Center Frequency and Span Settings for Harmonic Bands**

Softkey	Center Frequency	Span	Description
0-2.9 Gz BAND 0	1.45 GHz	2.9 GHz	Low-pass filtered, first harmonic mixing.
2.75-6.4 BAND 1	4.475 GHz	3.6 GHz	Preselected, first harmonic mixing
6.0-12.8 BAND 2	9.4 GHz	6.8 GHz	Preselected, second harmonic mixing.
12.4-19. BAND 3	15.9 GHz	7 GHz	Preselected, third harmonic mixing.
19.1-22 BAND 4	20.55 GHz	2.9 GHz	Preselected, fourth harmonic mixing.

The band lock function, **BND LOCK ON OFF**, locks the analyzer on a selected frequency band (local oscillator harmonic number). When only one frequency band is being swept the corresponding softkey will be underlined, even if band lock is off.

**Note**



When using the analyzer in a band lock mode, the span is limited to 3.6 GHz in band 0 and 1, and to 7 GHz in bands 2 through 4. To select the maximum span in a given band, use the start frequency, stop frequency, or span function.

**BAUD  
RATE**

is shown if you have an Option 023 (RS-232 interface). This softkey allows you to set the data transmission speed. (Also see "Copy.") The baud rate is set to 1200 by **DEFAULT CONFIG**.

**B -> C**

moves trace B into trace C.

**B <--> C**

exchanges trace B and trace C. Trace B is set to the view mode.

**B - DL -> B**

subtracts the display line from trace B and places the result in trace B. **B - DL -> B** is a math operation. See "**A - B -> A ON OFF**" for information about math operations.

**BLANK A** stores the amplitude data for trace A and removes it from the screen. The trace A register will not be updated as the analyzer sweeps.

**BLANK B** stores the amplitude data for trace B and removes it from the screen. The trace B register will not be updated as the analyzer sweeps.

**BLANK C** stores the amplitude data for trace C and removes it from the screen. The trace C register will not be updated as the analyzer sweeps.

**BLANK CARD** deletes all the files from the memory card. Pressing **BLANK CARD** causes a message to appear on the analyzer screen, **IF YOU ARE SURE, PRESS KEY AGAIN TO PURGE DATA**. Press **BLANK CARD** again if you want to delete all files from the memory card.

**BND LOCK ON OFF** is available for HP 8593A only. **BND LOCK ON OFF (ON)** locks the analyzer to the lowest frequency band (local oscillator harmonic number) containing the correct center frequency. Start and stop frequencies will be changed if necessary. When the band lock function is off, band(s) will be swept to their highest frequency (when possible), even though the start and stop frequencies allow single band sweeping. Executing a band lock limits the analyzer's tuning range to the selected harmonic number.

Selecting the softkeys for band 0 through band 4 turns on the band lock function automatically. When band lock is on, the band will be swept to its highest frequency (when possible), even though the start and stop frequencies allow single band sweeping only. If the start frequency is well within a lower band, turning band lock off will result in a multiband sweep. Changing to a multiband sweep removes the underlining of the band. Sweep of a single band is indicated by the underlining of the band.

---

**Note**



Before changing the frequency range to another harmonic, unlock the band with **BND LOCK ON OFF**. The harmonic band is unlocked when **OFF** is underlined.

---

**BW**

activates the bandwidth function and accesses the softkeys that control the bandwidth functions: **RES BW AUTO MAN**, **VID BW AUTO MAN**, **VBW/RBW RATIO**, **VID AVG ON OFF**, **9 kHz EMI BW**, and **120 kHz EMI BW**. (Also see "RES BW AUTO MAN.")

**CAL**

accesses the softkey menus for the self-calibration, service diagnostics, and service calibration functions. For more information about self-calibrating the analyzer, see "Improving Accuracy with Self-Calibration Routines" in Chapter 5.

**CAL AMPTD**

initiates an amplitude self-calibration routine. Connect **CAL OUT** to the analyzer input before initiating **CAL AMPTD**.

---

**Note**



If **CAL FREQ** and **CAL AMPTD** self-calibration routines are used, the **CAL FREQ** routine should always be performed before the **CAL AMPTD** routine.

---

**CAL FETCH** retrieves stored self-calibration correction factors. You can retrieve previously stored correction factors by pressing **CAL FETCH**.

**CAL FREQ** initiates a frequency self-calibration routine. Connect **CAL OUT** to the analyzer input before initiating **CAL FREQ**.

**CAL FREQ & AMPTD** initiates both the frequency and amplitude self-calibration routines. Connect **CAL OUT** to the analyzer input before initiating **CAL FREQ & AMPTD**.

**CAL MXR** is a service function, available for HP 8593A only. Refer to the Service Manual for more information.

**CAL STORE** copies the correction factors from working RAM to a memory area that allows the stored correction factors to be automatically retrieved when the analyzer is turned on. If correction factors are not stored, they will be retained until the analyzer is turned off.

**CAL TIMEBASE** is a service function only, refer to the Service Manual for more information.

**CAL TRK GEN** is available for the HP 8591A with Option 010 or 011. It performs absolute amplitude, vernier, and tracking peak self-calibration routines. The analyzer should be calibrated with **CAL AMPTD** prior to using **CAL TRK GEN**. Connect the tracking generator output to the analyzer input before initiating **CAL TRK GEN**.

**CAL YTF** is available for the HP 8593A only. **CAL YTF** generates the best slope and offset adjustment for the YIG-tuned preselector filter for each harmonic band. Connect **COMB OUT** to the analyzer input before initiating **CAL YTF**. (The **CAL YTF** function turns on the comb generator.) The frequency self-calibration routine should be performed before running the **CAL YTF** routine. **CAL YTF** should be performed before using **PRESEL DEFAULT**.

**CARD CONFIG** accesses the softkey menu that allows you to catalog, format, and delete data from a memory card.

**CARD -> DLP** recalls a downloadable program (DLP) saved on the memory card into the analyzer memory. To recall program data saved with a prefix, change the current prefix to the prefix the data was saved under before recalling the data. **LOAD FILE** is an alternate way to load program data from the memory card into analyzer memory. See "Saving and Recalling Data from the Memory Card" in Chapter 5 for more information. See also "CHANGE PREFIX."

**CARD -> STATE** recalls a state saved on the memory card into the analyzer memory. **CARD -> STATE** also displays the time and date when the state data was stored. To recall a state saved with a prefix, change the current prefix to the prefix the state was saved under before recalling the state data. **LOAD FILE** is an alternate way to load state data from the memory card into analyzer memory. See "Saving and Recalling Data from the Memory Card" in Chapter 5 for more information.

**CARD**  
**-> TRACE**

recalls a trace saved on the memory card into the analyzer memory. Limit lines and amplitude correction factors are recalled by pressing **CARD -> TRACE**, **LIMIT LINES** or **AMPLTUD COR FACT**. If the screen title does not exceed 34 characters, time and date when the trace data was stored is also displayed. The screen title and date are not recalled with limit-line files or amplitude correction factor files. To recall a trace, limit-line file, or amplitude correction factors file saved with a prefix, change the current prefix to the prefix the data was saved under before recalling the data. **LOAD FILE** is an alternate way to load trace data (but not recommended for recalling limit-line files or amplitude correction factor files) from the memory card into analyzer memory. See "Saving and Recalling Data from the Memory Card" in Chapter 5 for more information.

**CATALOG**  
**ALL**

catalogs all the programs and variables stored in analyzer memory when cataloging analyzer memory. Use **CATALOG REGISTER** to catalog states, traces, limit-line table(s), and amplitude correction factors saved in analyzer memory. **CATALOG ALL** catalogs all traces, states, amplitude correction factors, programs, and limit-line tables stored on the memory card when cataloging the memory card.

**CATALOG**  
**AMP CORR**

catalogs the amplitude correction factor files on the memory card. Use **CATALOG REGISTER** to catalog amplitude factors saved in analyzer memory (amplitude correction factors saved in analyzer memory are stored in trace registers). Amplitude correction factors are saved with an "a" before the memory card file name. Amplitude factors can be saved in analyzer memory by loading in amplitude correction factors from a memory card, defining amplitude correction factors using a remote programming command (**AMPCOR**), or using **EXECUTE TITLE**. See "Entering Amplitude Correction Factors" in Chapter 5 for more information.

**CATALOG**  
**CARD**

accesses a menu with the cataloging functions for the memory card: **CATALOG ALL**, **CATALOG STATES**, **CATALOG TRACES**, **CATALOG PREFIX**, **CATALOG DLP**, **CATALOG AMP CORR**, and **CATALOG LMT LINE**. Each catalog function displays catalog information and accesses **LOAD FILE** and **DELETE FILE**. The catalog contains information about the data stored on the memory card. (See Figure 7-1.)

Use the step keys to view different sections of the directory, and the knob to select a file. Use **LOAD FILE** to load the selected file into analyzer memory. Use **DELETE FILE** to delete the selected file from the memory card.

Unlike saving to the internal memory, data is saved as a file on the memory card. The files stored on the memory card are in the logical interchange format (LIF).

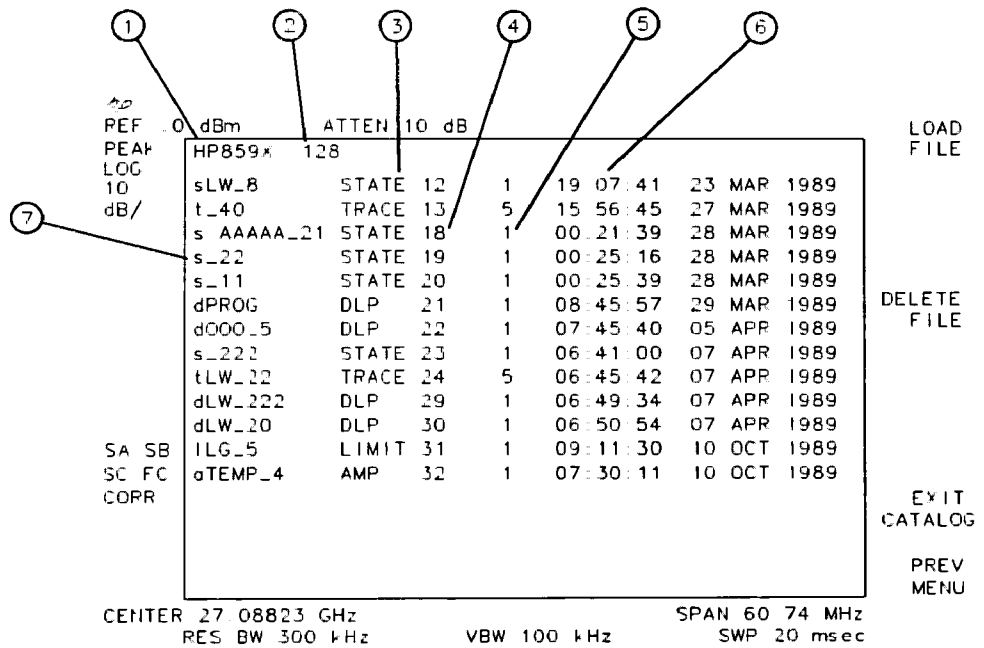

Figure 7-1. Memory Card Catalog Information

Table 7-3. Memory Card Catalog Information

Index Number	Title	Description
1	Volume Label	A label to identify the memory card. <b>FORMAT CARD</b> automatically assigns the volume label "HP859X" to the card.
2	Number of kilobytes	Displays the size of the memory card. <b>128</b> is the number of 256-byte blocks or records. It indicates it is a 32-kilobyte memory card (128 blocks × 256 bytes/block)/1024 bytes/kilobyte
3	Data Type	Indicates the type of data—trace, state, downloadable program (DLP), limit line (LIMIT), amplitude factors (AMP). The data type is determined by the letter preceding the filename (t, s, d, l, or a).
4	Starting Address	Indicates the physical record number of the start of the file.
5	File Length	Indicates number of records in the file.
6	Time of Creation	Indicates the time and date of file creation.
7	File name	The letter preceding the file name indicates the type of data of the file. t = trace data, s = state data, d = program data (downloadable program), l = limit line, a = amplitude factors. If the data was saved using a prefix, the prefix follows the first character in the file name. An underscore and the register number follow the prefix.

CATALOG  
DLP

catalogs all of the DLPs (downloadable programs) in analyzer memory or memory card. Downloadable programs can be saved in analyzer memory by loading in a downloadable program from the memory card or defining a function using remote programming commands (FUNCDEF or ACTDEF).

CATALOG  
INTRNL

accesses a menu with the cataloging functions for analyzer memory: CATALOG ALL, CATALOG REGISTER, CATALOG VARIABLES, CATALOG PREFIX, and CATALOG DLP. Each catalog function displays catalog information. The catalog contains information about the data stored in internal memory. See Figure 7-2.

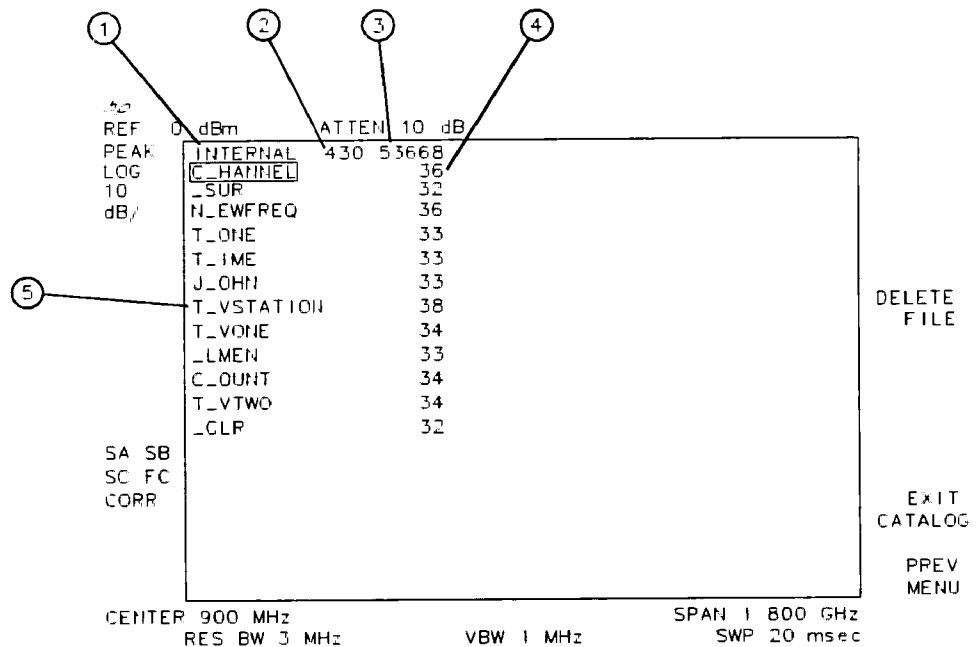

Figure 7-2. Analyzer Memory Catalog Information

Table 7-4. Analyzer Memory Catalog Information\*

Index Number	Description
1	Name of the catalog source.
2	Bytes of analyzer memory used.
3	Bytes of analyzer memory available.
4	Bytes used by item.
5	Name of item.

\* This table is not applicable when cataloging CATALOG REGISTER.

Unlike saving to the memory card, data is saved as an item in analyzer memory.



Use the step keys to view different sections of the directory, and the knob to select a file. The selected file is highlighted in inverse video.

Except for **CATALOG REGISTER**, each of the catalog functions access the menu with the **DELETE FILE** function. Use **DELETE FILE** to delete the item from analyzer memory.

**CATALOG REGISTER** accesses a menu with the **LOAD FILE** function. Use **LOAD FILE** to load a state or trace from analyzer memory. Do not use **LOAD FILE** to load limit-line table and amplitude correction factor items.

Also see "CATALOG ALL," "CATALOG VARIABLES."

**CATALOG  
LMT LINE**

catalogs the limit-lines on the memory card. Use **CATALOG REGISTER** to catalog limit-line tables stored in analyzer memory (limit-line tables saved in analyzer memory are stored in trace registers).

**CATALOG  
PREFIX**

catalogs all of the saved data on the memory card or analyzer memory with the specified prefix. The entire prefix does not have to be specified. For example, if you want to catalog all the files beginning with the prefix S, specify S as the prefix and then use **CATALOG PREFIX**. Prefixed items can be saved in analyzer memory by loading in a downloadable program from the memory card or defining a function using remote programming commands.

**CATALOG  
REGISTER**

displays the status of state and trace registers in analyzer memory. States 1 through 8 are displayed with the center frequency (denoted by CF) and span (denoted by SP). The status of trace registers 0 to the maximum number of traces is displayed also. If a trace, limit-line table(s), or amplitude correction factors have been saved in the trace register, the screen title (denoted by TL:) is displayed. If the screen title length allows, or if no title is saved with the trace, the time and date are displayed. To load the contents of the state or trace register into analyzer memory, use the knob or step keys to select the register and press **LOAD FILE**.

---

**Note**



Do not use **LOAD FILE** to load the contents of a trace register containing limit-line tables or amplitude correction factors.

---

**CATALOG  
STATES**

catalogs all of the states stored on the memory card.

**CATALOG  
TRACES**

catalogs all of the traces stored on the memory card.

**CATALOG  
VARIABLES**

catalogs all of the variables saved in analyzer memory. Variables can be saved in analyzer memory by loading in a downloadable program from the memory card or defining a function using remote programming commands (**VARDEF** or **TRDEF**).

---

**Note**

Variables beginning with an underscore are used by the analyzer firmware. Modifying these is not recommended and may give unexpected results.

---

**CENTER  
FREQ**

changes the center frequency.

**CF STEP  
AUTO MAN**

changes the step size for the center frequency function. Once a step size has been selected and the center frequency function is activated, the step keys change center frequency by the step-size value. The step size function is useful for finding harmonics and sidebands beyond the analyzer's current frequency span. When auto-coupled, the center frequency step size is set to one graticule (10% of the span).

**CHANGE  
PREFIX**

allows you to enter a prefix that can be used for saving and recalling data to and from the memory card, and for cataloging by the prefix. The prefix can be from one to seven characters long. The longer the prefix, the shorter the register number must be. The total length of the prefix and register number cannot exceed eight characters. The prefix can be any character; however, the underscore should not be the first character of the prefix.

Pressing **CHANGE PREFIX** accesses a menu containing the letters of the alphabet, the underscore symbol (\_), the number symbol (#), a space, and the clear function. To select a character, press the softkey that displays the group of characters that contains the desired character. The softkey menu changes to allow you to select an individual character. If you make a mistake, press **(BK SP)** to space back over the incorrect character. Additional characters are available by pressing **YZ\_# SPC CLEAR, MORE 1 of 2**. Numbers may be selected with the numeric keypad.

A prefix can be cleared with the clear function. Press **(CONFIG)** or **(DISPLAY)**, **CHANGE PREFIX, YZ\_# SPC CLEAR, CLEAR** to clear the current prefix. The current prefix is set to blank by **DEFAULT CONFIG**.

**CHANGE  
TITLE**

allows you to write a 53-character screen title across the top of the screen. The marker readout may interfere with the last 26 characters. The markers can be turned off by pressing **(MKR), MARKERS OFF**. **CHANGE TITLE** accesses the softkey menus which contain the characters and symbols available. The screen title will remain on the screen until **CHANGE TITLE** is activated again, **(PRESET)** is pressed, the screen title is cleared with the clear function, or a trace that has been saved with a screen title is recalled.

Pressing **CHANGE TITLE** accesses a menu containing the letters of the alphabet, the underscore symbol (\_), the number symbol (#), a space, and the clear function. To select a character, press the softkey that displays the group of characters that contains the desired character. The softkey menu changes to allow you to select an individual character. If you make a mistake, press **(BK SP)** to space back over the incorrect character. Additional characters are available by pressing **YZ\_# SPC CLEAR, MORE 1 of 2**. Numbers may be selected with the numeric keypad.

A screen title can be cleared by using the clear function. Pressing **DISPLAY**, **CHANGE TITLE**, **YZ\_# SPC CLEAR**, **CLEAR** to clear the current screen title.

**RPG TITLE** provides additional characters for **CHANGE TITLE**. **RPG TITLE** provides lowercase letters, numbers, Greek letters, and punctuation symbols. To access these additional characters, press **RPG TITLE**. When **RPG TITLE** is pressed, a character table appears on the screen. To select a character, turn the rotary-pulse generator (RPG) knob to position the cursor under the desired character and press the **ENTER** key. The step keys move the cursor between rows. When all characters have been entered, press **HOLD**. All other analyzer functions are inoperative until **HOLD** is pressed.

**CLEAR**

clears the current screen title or prefix.

**CLEAR  
WRITE A**

erases any data previously stored in trace A and continuously displays any signals detected in the frequency range of the analyzer. This function is activated by **PRESET** and power on.

**CLEAR  
WRITE B**

erases any data previously stored in trace B and continuously displays any signals detected in the frequency range of the analyzer. **PRESET** and power on selects **BLANK B**.

**CLEAR  
WRITE C**

erases any data previously stored in trace C and continuously displays any signals detected in the frequency range of the analyzer. **PRESET** and power on selects **BLANK C**.

---

### Note



Using **CLEAR WRITE C** with trace A or trace B in the clear-write or max hold mode causes trace A or trace B to be blanked. If you want to use trace A or trace B in the clear-write or max hold mode and do not want trace C to blank it, use min hold C or view C only. Using trace A or trace B in the clear-write mode changes trace C to the min hold mode.

---

**CNTL A  
0 1**

makes the auxiliary interface control line A output high or low (TTL).

**CNTL B  
0 1**

makes the auxiliary interface control line B output high or low (TTL).

**CNTL C  
0 1**

makes the auxiliary interface control line C output high or low (TTL).

**CNTL D  
0 1**

makes the auxiliary interface control line D output high or low (TTL).

**CNT RES  
AUTO MAN**

selects the resolution of the marker counter. The marker counter has a resolution range of 10 Hz to 100 kHz. The available resolution values are 1 Hz, 10 Hz, 100 Hz, 1 kHz, 10 kHz, and 100 kHz. The 1 Hz marker counter resolution is not specified. The resolution can be changed using the step keys or by entering the resolution using the numeric keypad. The marker counter resolution can be auto coupled to the span by pressing **CNT RES AUTO MAN** so that **AUTO** is underlined. **CNT RES AUTO MAN** is not affected by **AUTO ALL**.

COMB GEN  
ON OFF

is available for the HP 8593A only. This function turns the internal comb generator on (when ON is underlined) or off (when OFF is underlined). Connect a cable between 100 MHz COMB OUT and the analyzer input.

**CONFIG**

accesses the softkey menu for printer and plotter configuration, the time and date display functions, changing the current prefix, memory card configuration functions, disposing of user-defined variables and programs from analyzer memory, changing the analyzer address or the baud rate, and displaying the installed option on screen. Pressing **CONFIG** (LOCAL) after the analyzer has been placed in the remote mode places the analyzer in the local mode and enables front-panel control. During remote operation, R appears in the lower-right corner of the screen indicating remote mode. Pressing **CONFIG** removes the R symbol in the lower-right corner.

CONF  
TEST

initiates a variety of tests to check the major functions of the analyzer. It checks that the video bandwidths change, the noise floor level decreases as the resolution bandwidth narrows, the step gains switch, and the 3 dB bandwidths of the resolution bandwidths. CNF TEST PASS is displayed if the confidence test passes.

**COPY**

initiates an output of the screen data, without an external controller, to the graphics printer or plotter specified under **CONFIG**, PLOT CONFIG or PRINT CONFIG.

To obtain a print, press **CONFIG**, COPY PRNT PLT (so that PRNT is underlined), PRINT CONFIG. For Option 021, use PRINTER ADDRESS to change the HP-IB address of the printer, if necessary. For Option 023, use BAUD RATE to change the baud rate of the analyzer, if necessary.

If the analyzer is connected to an HP PaintJet printer and you want a color printout, press PAINTJET PRINTER. If the analyzer is connected to an HP PaintJet printer and you want a black and white printout, press B & W Printer.

If you want the softkey labels to be printed with the analyzer display printout, press PRT MENU ON OFF so that ON is underlined.

Press **COPY** and the process will begin. The screen remains frozen (no further sweeps taken) until the data transfer to the printer is complete. The analyzer works with many Hewlett-Packard printers.

The plotting process is similar to the printing process. On the analyzer, press **CONFIG**, PLOT CONFIG. For Option 021, use PLOTTER ADDRESS to change the HP-IB address for the plotter, if necessary. For Option 023, use BAUD RATE to change the baud rate of the analyzer, if necessary.

With PLTS/PG 1 2 4, you can choose a full-page, half-page, or quarter-page plot. Press PLTS/PG 1 2 4 to underline the number of plots per page desired. If two or four plots per page are chosen, a function is displayed that allows you to select the location of the plotter output on the paper. If two plots per page are selected, PLT [ ]LOC \_ \_ function is displayed. If four plots per page are selected PLT [ ] \_LOC \_ \_ is displayed. Press the softkey until the rectangular marker is in the desired section of softkey label. The

upper and lower sections of the softkey label graphically represent where the plotter output will be located.

For a multipen plotter, the pens of the plotter draw the different components of the screen as follows:

Pen Number	Description
1	Draws the annotation and graticule.
2	Draws trace A.
3	Draws trace B.
4	Draws trace C and the display line.
5	Draws user-generated graphics.

Press **PREV MENU**, **COPY DEV PRNT PLT** (PLT should be underlined), and **COPY**.

Printing is usually faster than plotting, but plotting provides higher resolution output. The analyzer works with plotters such as the HP 7440A.

Figure 7-3 shows the rear view of a typical printer/spectrum-analyzer configuration.

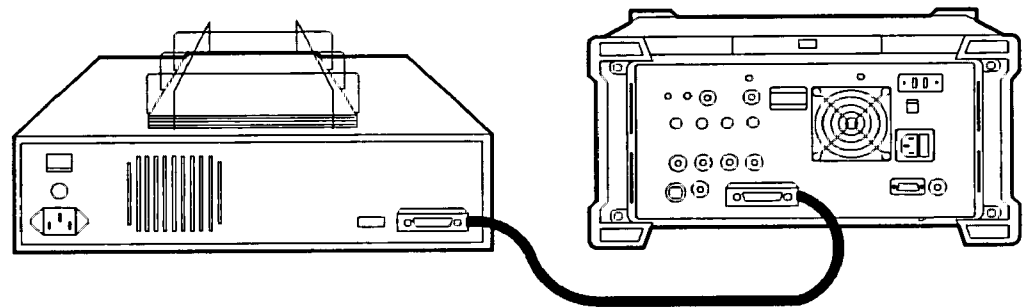

**Figure 7-3. Connecting a Printer to the Analyzer**

**Note**



Printing and plotting require an optional interface. Generally, spectrum analyzers with HP-IB set the plotter address to 5 and the printer address to 1. Analyzers with RS-232 must have the baud rate set according to the printer or plotter being used. The programming manual that comes with the optional interfaces detail peculiarities of the different interfaces. Refer to the *HP 8590 Series Programming Manual* for more information.

**COPY DEV PRNT PLT** is available for Option 021 or 023 only. **COPY DEV PRNT PLT** changes between a printer and plotter (if you have an Option 021 or 023). For example, if

you have been printing and want to do a plot, press **COPY DEV PRNT PLT** to underline **PLT** before pressing **COPY**.

**CORRECT  
ON OFF**

controls use of some of the correction factors. When **ON** is underlined, correction factors are used and **CORR** appears on the display. When **OFF** is underlined, correction factors are not used. Turning the correction factors off degrades amplitude accuracy.

---

**Note**



Correction factors must be on for the analyzer to meet its specified performance.

---

**CRT HORZ  
POSITION**

changes the horizontal screen position of the analyzer display. Press **CAL STORE** if you want the analyzer to use this position when power is turned on.

**CRT VERT  
POSITION**

changes the vertical position of the analyzer's screen. Press **CAL STORE** if you want the analyzer to use this position when power is turned on.

**DATEMODE  
MDY DMY**

changes the display of the date from a month-day-year format to a day-month-year format. It is set to month-day-year format by **DEFAULT CONFIG**.

**dBm**

changes the amplitude units to dBm for the current setting (log or linear).

**dBmV**

changes the amplitude units to dBmV for the current setting (log or linear).

**dBuV**

changes the amplitude units to dB $\mu$ V for the current setting (log or linear).

**DEFAULT  
CAL DATA**

accesses the predetermined correction factors. A special pass code is required for use. See Chapter 8 for more information.

**DEFAULT  
CONFIG**

resets the analyzer configuration to the state it was in when it was originally shipped from the factory. See Table 7-5 for the default user-configuration values set be **DEFAULT CONFIG**.

**Table 7-5. Default Configuration Values**

Configuration	Default Value
Analyzer address (Option 021)	18
Copy device	printer
CRT position (Horizontal and Vertical)	cal store values
Printer address (Option 021 or 023)	1
Plotter address (Option 021 or 023)	5
Baud rate (Option 023)	1200
External preamp	0 dB
Save lock (internal states or traces)	Off
Printer	black and white printer
Prt menu	on
Plots per page	1
Time/date display	on
Date mode	month-day-year format
Prefix	(blank)
Analyzer state	PRESET

**DELETE FILE** function allows you to delete an item from analyzer memory or a file from the memory card. **DELETE FILE** is not available for deleting state or trace data from analyzer memory (see **CATALOG REGISTER** ). Use the step keys to view different sections of the directory and use the knob to select the file or item to delete. Pressing **DELETE FILE** causes a message to appear on the analyzer screen, **IF YOU ARE SURE, PRESS KEY AGAIN TO PURGE DATA**. Press **DELETE FILE** again if you want to delete the memory item.

**Note**



Deleting items from analyzer memory beginning with an underscore is not recommended and may have unexpected results. Items beginning with an underscore are used by the analyzer.

**DELETE SEGMENT** deletes limit-line entry with the segment number highlighted. Press **SELECT SEGMENT** then enter the segment number to select the limit-line entry for deletion.

**DELTA MEAS** finds and displays the frequency and amplitude differences between the two highest-amplitude signals. **DELTA MEAS** performs the following key sequence: **PEAK SEARCH**, **MARKER DELTA** , **NEXT PEAK** .

**DEMODO** is available if Option 102 is installed. **DEMODO** accesses the softkeys controlling demodulation functions, speaker, squelch level, FM gain, and dwell time.

**DEMODO AM FM** is available if Option 102 is installed. **DEMODO AM FM** changes between amplitude and frequency demodulation.

Activating AM detection turns off FM demodulation (if it is on). When the frequency span is greater than 0 Hz, a 30 kHz resolution bandwidth is used during demodulation, regardless of the screen annotation. When the span is equal to 0 Hz, the displayed bandwidth is used.

Turning FM demodulation on turns off AM demodulation (if it is on). When the frequency span is greater than 0 Hz, a 100 kHz bandwidth is used during the demodulation, regardless of the screen annotation. When the span is equal to 0 Hz, the displayed bandwidth is used.

DEMODO  
ON OFF

is available if Option 102 is installed. **DEMODO ON OFF** turns the AM or FM demodulation on or off. If the analyzer is in a nonzero span, a marker is placed at center screen (if an on-screen marker is not already present). The marker pause is enabled to the current dwell time value. Demodulation takes place on any signal indicated by the marker position during the marker pause. There is no change to the display during marker pause, but the demodulation signal is present on the AUX VIDEO OUT. Also see "SPEAKER ON OFF."

**DEMODO ON OFF** selects the sample peak detector for AM demodulation, the FMV detector for FM demodulation. If the analyzer is in zero span, demodulation is done continuously with or without an on-screen marker.

DETECTOR  
SAMPL PK

selects between sample and peak detection. When sample detection is selected, **SMPL** appears in the upper-left corner of the screen. When peak detection is selected, **PEAK** appears in the upper-left corner of the screen.

In sample mode, the instantaneous signal value at the present display point is placed in memory. Sample detection is activated automatically for noise level markers, during video averaging, and for FFT measurements. Peak detection obtains the maximum video signal between the last display point and the present display point and stores this value in the trace memory address.

**PRESET** and power-on select peak detection.

**DISPLAY**

accesses softkeys that activate the display line and threshold, allow title and prefix entry, and control the display of the graticule and screen annotation.

DISPLAY  
CNTL I

displays the status (high = 1 or low = 0 in TTL) of the auxiliary connector input (control line I), on the analyzer screen.

DISPOSE  
USER MEM

allows you to dispose of all the user programs and variables in analyzer memory. Pressing **DISPOSE USER MEM** causes a message to appear on the analyzer screen, **IF YOU ARE SURE, PRESS KEY AGAIN TO PURGE DATA**. Press **DISPOSE USER MEM** again if you want to dispose of all the user-defined programs and variables. If you do not want to dispose of all the user programs, press a function other than **DISPOSE USER MEM**.

**DISPOSE USER MEM** does not dispose of limit-line tables or amplitude correction factors in analyzer memory.

---

### Note



Use **DELETE FILE** to delete stored programs or variables from analyzer memory selectively.

---

Using **DISPOSE USER MEM** may change the printer or plotter configuration. **DISPOSE USER MEM** sets the printer output **B & W PRINTER**, **COPY DEV PRNT PLT** to **PRNT**, and **PRT MENU ON OFF** to on. Use **PRINT CONFIG** to change any of these functions.



<b>DSP LINE ON OFF</b>	activates an adjustable horizontal line that is used as a visual reference line. The line, which can be used for trace arithmetic, has amplitude values that correspond to its vertical position when compared to the reference level. The value of the display line appears in the active function block and on the left side of the screen. The display line can be adjusted using the step keys, knob, or numeric keypad. To deactivate the display line, press <b>DSP LINE ON OFF</b> so that OFF is underlined. (Also see "VIDEO.")
<b>DWELL TIME</b>	sets the dwell time for the marker pause, during which demodulation can take place in nonzero span sweeps (for Option 102 only). The dwell time can be set from 2 ms to 100 s.
<b>EDIT DONE</b>	erases the limit-line table from the analyzer's screen and restores the menu accessed by <b>LIMIT LINES</b> . Use <b>EDIT DONE</b> when all the limit-line values have been entered.
<b>EDIT FLATNESS</b>	allows you to view the flatness data. This is a service calibration function and is designed for service use only.
<b>EDIT LIMIT</b>	allows you to edit the current limit-line table(s) by accessing <b>EDIT UPPER</b> , <b>EDIT LOWER</b> , <b>EDIT UP/LOW</b> , and <b>EDIT MID/DELTA</b> . Use <b>NEW LIMIT</b> to dispose of the current limit-line table.
<b>EDIT LOWER</b>	allows you to view or edit the lower limit-line table. Up to 20 entries are allowed for the lower limit-line table. With the lower limit-line table format, the coordinates for the lower limit-line are specified (but not for the upper limit-line). Even if upper limit-line values exist or the values had been entered as an upper and lower limit-line table, the lower limit-line values are treated as a separate table from the upper limit-line values. The lower limit-line entries can have independent frequency and amplitude coordinates from upper limit-line table entries.
<b>EDIT MID/DELT</b>	allows you to view or edit the upper and lower limit-line tables by entering a middle amplitude value and an amplitude deviation. Up to 20 entries are allowed for the upper and lower limit-line tables. Like the upper and lower limit-line table format, the mid/delta limit-line table format provides a means of specifying the upper and lower limit-lines at the same time. Unlike the upper and lower table format, the amplitude values are specified as a middle amplitude value with a delta (the upper and lower limit-lines are drawn an equal positive and negative distance from the middle amplitude). With the mid/delta format, the frequency and the middle amplitude plus the delta comprise the upper limit-line; the frequency and the middle amplitude minus the delta comprise the lower limit-line. The difference between the mid/delta and the upper/lower format is the way the amplitude values are entered; the frequency coordinate begins a segment regardless of the format chosen. The mid/delta format can be used if the upper and lower limit-lines are symmetrical (with respect to the amplitude axis).
<b>EDIT UP/LOW</b>	allows you to view or edit the upper and lower limit-line tables. Up to 20 entries are allowed for the upper and lower limit-line tables. With the upper and lower limit-line table format, the upper and lower limit-lines can be entered at the same time. With the upper and lower limit-line format, the frequency, upper amplitude, and lower amplitude are specified. The frequency

and upper amplitude comprise the coordinate point for the upper limit-line, the frequency and lower amplitude value comprise the coordinate point for the lower limit-line. It is not necessary to specify both an upper and lower amplitude component for every frequency component.

**EDIT  
UPPER**

allows you to view or edit the upper limit-line table. Up to 20 entries are allowed for the upper limit-line table. With the upper limit-line table format, the coordinates of the upper limit-line are specified (but not for the lower limit-line). Even if lower limit-line values exist or the values had been entered as an upper and lower limit-line table, the upper limit-line values are treated as a separate table from the lower limit-line values. The upper limit-line entries can have independent frequency and amplitude coordinates from lower limit-line table entries.

**EDIT  
UPR LWR**

selects upper or lower limit-line tables.

**EXECUTE  
TITLE**

executes the remote commands that appear in the screen title. See "Entering Amplitude Correction Factors" in Chapter 5 for information about using **EXECUTE TITLE** to enter amplitude correction factors.

**EXIT**

exits **EDIT FLATNESS** **EDIT FLATNESS** is a service calibration function and is designed for service use only.

**EXIT  
CATALOG**

returns the analyzer to the state it was in before the current catalog function was invoked.

**EXIT  
SHOW**

removes the screen annotation left by **SHOW OPTIONS**.

**EXTERNAL**

activates the trigger condition that allows the next sweep to start when an external voltage (connected to the **EXT TRIG INPUT** on the rear panel) passes through approximately 1.5 volts, becoming positive. The external trigger signal must be a 0 V to +5 V TTL signal.

**EXT  
PREAMP**

is similar to **REF LVL OFFSET**. It adds a positive or negative preamplifier gain value, which is subtracted from the displayed signal. Unlike **REF LVL OFFSET**, attenuation may be changed depending on the preamplifier gain entered. A preamplifier gain offset is used for measurements that require an external preamplifier or long cables. The offset is subtracted from the amplitude readout so that the displayed signal level represents the signal level at the input of the preamplifier. The preamplifier gain offset is displayed at the top of the screen and is removed by entering zero. The preamplifier gain offset is entered using the numeric keypad.

Press **CAL STORE** if you want the analyzer to use the current preamplifier gain offset when power is turned on. Preamplifier gain offset is set the zero by **DEFAULT CONFIG**.

**FFT  
MEAS**

transforms zero span data into the frequency domain using a fast Fourier transform. After using the FFT function, the display is always in log mode, 10 dB per division and in single sweep triggering. After using the FFT function, the markers are still in FFT mode for use in evaluating the data. The markers must be turned off before attempting to use them in the usual

manner. See Chapter 6, "Measuring Amplitude Modulation with the Fast Fourier Transform Function," for more information.

**FLAT** draws a zero-slope line between the coordinate point of the current segment and the coordinate point of the next segment, producing limit-line values equal in amplitude for all frequencies between the two points. If the amplitude values of the two segments differ, the limit line "steps" to the value of the second segment.

**FLATNESS DATA** accesses **EDIT FLATNESS**, which allows you view the flatness and gain correction factors stored in the analyzer's memory. This is a service calibration function and is designed for service use only.

**FM GAIN** is available with Option 102 only. **FM GAIN** adjusts the top-to-bottom screen deviation from center screen of the signal (FM demodulation only). The range for FM gain is from 10 kHz to 500 kHz. The default value is 100 kHz.

**FORMAT CARD** formats a card in logical interchange format (LIF). The memory card is formatted with the volume label "HP859X." Pressing **FORMAT CARD** causes a message to appear on the analyzer screen, **IF YOU ARE SURE, PRESS KEY AGAIN TO PURGE DATA**. Press **FORMAT CARD** again if you want to format the memory card. **FORMAT CARD** deletes data stored on the memory card.

**FREE RUN** activates the trigger condition that allows the next sweep to start as soon as possible after the last sweep.

**FREQ OFFSET** adds an offset value to the frequency readout to account for pre-analyzer frequency conversions. Offset entries are added to all frequency readouts including marker, start frequency, and stop frequency. Entering an offset does not affect the trace. Offsets are not added to the span. Frequency offsets are entered with the numeric keypad.

When a frequency offset is entered, its value is displayed on the bottom of the screen (as opposed to reference level offsets, which are displayed on the left side of the screen). To eliminate an offset, press **FREQ OFFSET**, 0 **(ENTER)**. **(PRESET)** also sets the offset to zero.

**(FREQUENCY)** activates the center frequency or start frequency function and accesses the menu with the frequency functions. The center frequency or start frequency value appears below the graticule on the screen.

Although the spectrum analyzer allows entry of frequencies greater than the specified frequency range, using frequencies greater than the frequency span of the analyzer is not recommended and is not guaranteed to meet specifications.

---

**Note**



When changing both the center frequency and span, change the frequency first since the span can be limited by the frequency value.

---

**FULL SPAN** changes the analyzer span to full span. For the HP 8591A, full span is 0 to 1.8 GHz. For the HP 8593A, full span is 2.75 to 22 GHz. For the HP 8593A, **FULL SPAN** keeps span within the current harmonic band if harmonic band lock is on.

**GHIJKL** accesses the softkey menu for selecting screen title or prefix characters G through L.

**GRAT  
ON OFF** turns the screen graticule on and off. This is helpful when alternative graphics are drawn on the screen through a remote controller and during plotting, when a graticule is not required.

**INPUT Z  
50 75** sets the input impedance for voltage-to-power conversions. The impedance you select is for computational purposes only, since the actual impedance is set by internal hardware of 50Ω (except for Option 001). The preset value is configurable with a service function. Select the computational input impedance by pressing **INPUT Z 50 75**, or entering 75 or 50 using the numeric keypad.

**INTRNL  
CRD** selects between analyzer memory and the memory card for the save and recall functions.

**INTRNL  
-> STATE** recalls the saved analyzer state from the selected state register. Recalling a state from the analyzer memory displays the time and date when the state data was stored. To recall a state, press **INTRNL -> STATE**, and use the numeric keypad to enter a state register number (valid state register numbers are 1 through 9). State register 9 contains a previous state, state register 0 contains the current state.

**INTRNL  
-> TRACE** accesses a softkey menu which allows you to select the trace in which the trace data is to be recalled (trace A, trace B, or trace C), recall the current limit-line tables, or recall amplitude correction factors. When recalling a trace, select the trace in which the trace data is to be recalled, enter the trace register number, and press **(ENTER)**. When recalling limit-line tables or amplitude correction factors, press **LIMIT LINES** or **AMPLTUD COR FACT** respectively, enter the trace register number, and press **(ENTER)**. Valid trace registers numbers are 0 through the maximum register number. The maximum register number is the number displayed after **MAX REG # =** during a save or recall operation. If a screen title is present, it is recalled with the trace data (but not limit lines or amplitude correction factors). If the screen title does not exceed 34 characters, the time and date when the data was stored will also be displayed.

**INVALID SAVEREG** is displayed if data has not been stored in the trace register.

**LIMIT  
LINES** When accessed by **(MEAS/USER)**, **LIMIT LINES** accesses the limit-line menus. When accessed by **(SAVE)**, **LIMIT LINES** stores the current limit-line table(s) in analyzer memory or on the memory card. When accessed by **(RECALL)**, **LIMIT LINES** recalls limit-line table(s) from analyzer memory or the memory card. See "To Save a Limit-Line Table or Amplitude Correction Factors" or "To Recall Limit-Line Tables or Amplitude Correction Factors" in Chapter 5 for more information.

**LIMITS  
FIX REL** allows you to choose fixed or relative type of limit lines. The fixed (**FIX**) type uses the current limit-line as a reference for fixed frequency and amplitude values when activated. The relative (**REL**) setting causes the current limit-line value to be relative to the displayed center frequency and reference-level amplitude values. For example, if a limit line is specified as

fixed, entering a limit-line segment with a frequency coordinate of 300 MHz displays the limit-line segment at 300 MHz. If the same limit-line table is specified as relative, it is displayed relative to the analyzer's center frequency and reference level. If the center frequency is at 1.2 GHz, a relative limit-line segment with a frequency coordinate of 300 MHz will display the limit-line segment at 1.5 GHz. If the amplitude component of the relative limit-line segment is -10 dB, then -10 dB is added to the reference level value to obtain the amplitude of the given component (reference level offset included).

RELATIVE is displayed in the limit-line table when the limit-line type is relative; FIXED is displayed when limit-line type is fixed.

A limit line entered as fixed may be changed to relative, and one entered as relative may be changed to fixed. When changing between fixed and relative limit-lines, the frequency and amplitude values in the limit-line table change so that the limit line remains in the same position for the current frequency and amplitude settings of the spectrum analyzer.

LIMITS  
ON OFF

turns the limit-line testing and the limit lines on or off. When limit-line testing is enabled, every measurement sweep of trace A is compared to the limit lines. If trace A is at or within the bounds of the limit lines, LIMIPASS is displayed. If trace A is out of the limit-line boundaries, LIMIFAIL is displayed.

LINE

activates the trigger condition that allows the next sweep to be synchronized with the next cycle of the line voltage.

LOAD  
FILE

When the memory card is selected, any of the catalog functions ( CATALOG ALL , CATALOG STATES , CATALOG TRACES , CATALOG PREFIX , CATALOG DLP , CATALOG AMP CORR , or CATALOG LMT LINE ) accesses LOAD FILE . LOAD FILE loads a file from the memory card into analyzer memory. When cataloging analyzer memory with CATALOG REGISTER , LOAD FILE can be used to recall the contents of a state or trace register into analyzer memory. To use LOAD FILE , use the step keys to view sections of the directory, and use the knob to select a file for the load file function. Trace data is loaded into trace B. See "CATALOG CARD" and "CATALOG REGISTER."

---

Note



Use of LOAD FILE is not recommended for recalling limit-line tables or amplitude correction factors stored in analyzer memory.

---

(LOCAL)

Pressing **CONFIG** (LOCAL) after the analyzer has been placed in the remote mode places the analyzer in the local mode and enables front-panel control. During remote operation, R appears in the lower-right corner of the screen indicating remote and talk. A T or L may appear during remote operation, indicating talk or listen. Pressing the **CONFIG** key removes the R symbol in the lower-right corner.

**MAN\_TRK  
ADJUST**

is available for HP 8591A with Option 010 or 011 only. **MAN TRK ADJUST** allows the user to adjust the frequency of the tracking-generator oscillator manually using the step keys or knob. The tracking adjust is tuned to maximize the amplitude of the trace.

Tracking error occurs when the output frequency of the tracking generator is not exactly matched to the input frequency of the spectrum analyzer. The resulting mixing product from the spectrum analyzer input mixer is not at the center of the IF bandwidth. Any tracking errors may be compensated for through manual adjustments of the tracking generator's oscillator, or through an automatic tracking routine, **TRACKING PEAK**.

**MARKER  
AMPTD**

keeps the active marker at the requested amplitude on the screen. Once activated, the marker remains at the amplitude selected by the step keys, knob, or numeric keypad, even as the signal frequency is changed. The marker will be placed at the leftmost signal at that amplitude. If no signal exists at that amplitude, it will be placed above the highest signal amplitude (or below the lowest trace element if it is below all trace elements). When a marker delta is active in addition to marker amplitude, the behavior of the active marker is useful for measuring signal bandwidths. For example, place a marker 20 dB below the peak of a signal, press **MARKER DELTA**, **MARKER AMPTD**. The marker readout shows the 20 dB bandwidth.

**MARKER  
-> CF**

changes the analyzer settings so that the frequency at the marker becomes the center frequency.

**MARKER  
-> CF STEP**

assigns the frequency value of the active marker to the center frequency step size. Press **FREQUENCY**, **CF STEP AUTO MAN** to view the step size. If marker delta is active, the step size will be set to the frequency difference between the markers.

**MARKER  
DELTA**

activates a second marker at the position of the first marker. (If no marker is present, two markers appear at the center of the display.) The amplitude and frequency of the first marker is fixed, and the second marker is under your control. Annotation in the active function block and in the upper-right corner of the screen indicates the frequency and amplitude differences between the two markers.

---

**Note**



If there are already two markers when **MARKER DELTA** is pressed, the nonactive marker disappears, the active marker becomes a reference marker, and the delta marker becomes the active marker.

---

**MARKER  
NORMAL**

activates a single frequency marker at the center frequency on the active trace if there is no on-screen marker. If there is an on-screen marker before the **MARKER NORMAL** function is enabled, a frequency marker is enabled at the position of the first marker. Use the data controls to position the marker. Annotation in the active function block and in the upper-right corner indicates the frequency and amplitude of the marker. The marker stays on the trace at the horizontal screen position where it was left unless **SIGNAL TRACK**, **MARKER AMPTD**, or a "marker to" function (**MARKER -> CF**,

	MARKER -> REF LVL , MARKER -> CF STEP , MKR Δ -> SPAN , or MINIMUM -> MARKER ) is engaged. MARKER NORMAL turns off MARKER DELTA .
MARKER -> REF LVL	changes the analyzer settings so that the amplitude at the active marker becomes the reference level.
MARKERS OFF	turns off all markers, including signal track and the demodulation at the marker (for Option 102, if demodulation has been enabled). Marker annotation is removed.
MAX HOLD A	updates each trace point of trace A with the maximum level detected at each point during successive sweeps.
MAX HOLD B	updates each trace point of trace B with the maximum level detected at each point during successive sweeps.
MAX MXR LEVEL	lets you change the maximum input mixer level in 10 dB steps from -10 dBm to -100 dBm. The mixer level is equal to the reference level minus the attenuator setting. As the reference level changes, the input attenuator setting is changed to keep the power levels less than the selected level at the input mixer. <b>PRESET</b> resets the maximum input mixer level to -10 dBm.
<b>MEAS/USER</b>	switches between the menu containing <b>USER MENU(S)</b> , <b>FFT MEAS</b> , <b>3dB POINTS</b> , <b>6 dB POINTS</b> , <b>LIMIT LINES</b> , <b>MORE 1 of 2</b> and the user menu. If no keys have been defined in the user menu, <b>NO USER MENU</b> is displayed. See <i>HP 8590 Series Spectrum Analyzer Programming Manual</i> for more information about defining keys in the user menu.
MIN HOLD C	updates each trace point of trace C with the minimum level detected at each point during successive sweeps.
MINIMUM -> MARKER	moves the active marker to the minimum detected amplitude value.
MKNOISE ON OFF	reads out the average noise level referenced to a 1 Hz noise power bandwidth at the marker position. If no marker is present, a marker appears at the center of the screen. The root-mean-square noise level, normalized to a 1 Hz noise power bandwidth, is read out. The sample detector is activated.
MKPAUSE ON OFF	stops the analyzer sweep at the marker position for the duration of the dwell time.  The dwell time can be set from 2 milliseconds to 100 seconds.
<b>MKR</b>	accesses the marker functions. Markers are diamond-shaped characters that identify points of traces and allow the traces to be manipulated and controlled on the screen. During manual operation, two markers may appear on the display simultaneously; only one can be controlled at a time. The marker that is controlled is called the "active" marker. <b>MKR</b> activates the <b>MARKER NORMAL</b> function.
<b>MKR-&gt;</b>	(read "marker to") calls up the softkeys for the transfer of marker information directly into other functions.

**MKR CNT  
ON OFF**

turns on the marker counter when **ON** is underlined. If no marker is active before **MKR CNT ON OFF** is pressed, a marker is activated at center screen. Press **MKR CNT ON OFF** (so that **OFF** is underlined), to turn the marker counter off. Use **CNT RES AUTO MAN** to change the marker counter resolution to an uncoupled value. The ratio of the resolution bandwidth to span must be greater than 0.01 for the marker function to work properly. **DECR SPAN** appears on screen if the bandwidth to span ratio is less than 0.01.

**MKR Δ  
-> SPAN**

sets the start and stop frequencies to the values of the delta markers. The start and stop frequencies will not be set if the delta marker is off.

**MNOPQR**

accesses the softkey menu for selecting screen title or prefix characters M through R.

**MODE**

changes the softkey menus for the **SPECTRUM ANALYZER** and other modes of operation with the **PRESET SPECTRUM** function. Consult the documentation accompanying the HP 85711A Cable Television Measurements Card, the HP 85712A EMI Diagnostics Measurements Card, or the HP 85713A Digital Radio Measurements Card for information about these other modes of operation.

**NEW  
LIMIT**

clears the limit-line table. Pressing **NEW LIMIT** causes the message to be displayed **IF YOU ARE SURE, PRESS KEY AGAIN TO PURGE DATA**. Press **NEW LIMIT** again to clear the limit-line table. Use **SAVE LIMIT** to save the limit-line table, then use **NEW LIMIT** to clear the limit-line table.

**NEXT  
PEAK**

places the marker on the next highest peak. The signal peak must exceed the threshold value. (Also see "PEAK EXCURSN" and "THRESHLD ON OFF.")

**NEXT PK  
LEFT**

moves the marker to the next peak to the left of the current marker. The signal peak must exceed the threshold value. If there is no peak to the left, the marker will not move. (Also see "PEAK EXCURSN" and "THRESHLD ON OFF.")

**NEXT PK  
RIGHT**

moves the marker to the next peak to the right of the current marker. The signal peak must exceed the threshold value. If there is no peak to the right, the marker will not move. (Also see "PEAK EXCURSN" and "THRESHLD ON OFF.")

**NORMLIZE  
ON OFF**

subtracts trace B from trace A and adds the result to the display line. The result is displayed in trace A. The trace data is normalized with respect to the display line even if the value of the display line is changed. This function is executed on all subsequent sweeps until it is turned off. A minus sign (-) appears between the trace A status and the trace B status in the screen annotation while the function is active. To deactivate **NORMLIZE ON OFF**, press **NORMLIZE ON OFF** so that **OFF** is underlined.

**NORMLIZE ON OFF** is useful for applying correction data to a trace. For example, store a measurement sweep of the response of a system in trace B. Trace A can be used to measure the response of the system after a device is added. Use **NORMLIZE ON OFF** to subtract the system response from the



	response with the device under test in order to characterize the response of a device under test.
<b>NORMLIZE POSITION</b>	displays the display line and makes the display line function active. The trace data is normalized with respect to the display line even if the value of the display line is changed.
<b>NO USER MENU(S)</b>	is displayed if key number 1 has not been defined by the user. Key number 1 can be defined by remote programming commands (KEYCMD or KEYDEF).
<b>NTSC</b>	is available if Options 101 and 102 are installed. <b>NTSC</b> allows you to trigger on the NTSC video format. <b>NTSC</b> alters the TV line number the analyzer triggers on internally; the line number displayed by <b>TV LINE #</b> does not change. <b>NTSC</b> changes the video modulation to negative; use <b>TV SYNC NEG POS (POS)</b> if positive video modulation is required.
<b>PAINTJET PRINTER</b>	is available for Option 021 or 023 only. <b>PAINTJET PRINTER</b> allows a printer output to an HP PaintJet printer. The traces are displayed in orange (trace A), blue (trace B), and red (trace C). The graticule, annotation, and user information are displayed in black.
<b>PAL</b>	is available if Options 101 and 102 are installed. <b>PAL</b> allows you to trigger on the PAL video formats. <b>PAL</b> alters the TV line number the analyzer triggers on internally; the line number displayed by <b>TV LINE #</b> does not change. <b>PAL</b> changes the video modulation to negative; use <b>TV SYNC NEG POS (POS)</b> if positive video modulation is required.
<b>PAL-M</b>	is available if Options 101 and 102 are installed. It allows you to trigger on the PAL-M video formats. <b>PAL-M</b> alters the TV line number the analyzer triggers on internally; the line number displayed by <b>TV LINE #</b> does not change. <b>PAL-M</b> changes the video modulation to negative; use <b>TV SYNC NEG POS (POS)</b> if positive video modulation is required.
<b>PEAK EXCURSN</b>	sets the minimum amplitude variation of signals that the marker can identify as a peak. If a value of 10 dB is selected, the marker moves only to peaks that rise and fall more than 10 dB above the threshold line (or the noise floor of the display). Pushing <b>PRESET</b> or turning on power resets the excursion to 6 dB, and the threshold to 70 dB below the reference level.

---

**Note**



When a peak has a lump on its skirt that is peak excursion above the threshold, it is considered a peak in its own right only if it has a peak excursion drop on both sides. Two peaks that are so close that only a valley divides them are not differentiated if the valley is not peak-excursion deep.

---

When the peak excursion value is less than 6 dB, the marker-peaking functions may not recognize signals less than 6 dB above the noise floor. To correct this, when measuring signals near the noise floor, the excursion value can be reduced even further. To prevent the marker from identifying noise as signals, reduce the noise floor variance to a value less than the peak excursion by reducing the video bandwidth or using video averaging.

PEAK MENU	accesses the softkeys under <b>PEAK SEARCH</b> (see "PEAK SEARCH" below). Pressing <b>PEAK MENU</b> instead of <b>PEAK SEARCH</b> lets you use the peak search functions without initiating a new peak search.
<b>PEAK SEARCH</b>	automatically places a marker on the highest amplitude of a trace, displays the marker's amplitude and frequency, and accesses <b>MARKER -&gt; CF</b> , <b>MARKER DELTA</b> , <b>NEXT PEAK</b> , <b>NEXT PK RIGHT</b> , <b>NEXT PK LEFT</b> , and <b>PEAK EXCURSN</b> .
PK-PK MEAS	finds and displays the frequency and amplitude differences between the highest and lowest signals. <b>PK-PK MEAS</b> performs the following routine: <b>PEAK SEARCH</b> , <b>MARKER DELTA</b> , and then moves the second marker to the lowest detected signal.
PLOT CONFIG	is available for Option 021 or 023 only. <b>PLOT CONFIG</b> accesses the menu to address the plotter and select from plotter options. (Option 021 or 023 only.)
PLOTTER ADDRESS	is available for Option 021 only. <b>PLOTTER ADDRESS</b> changes the HP-IB address of the plotter. The plotter address is set to 5 by <b>DEFAULT CONFIG</b> .
PLT - - LOC - -	selects the position of the plotter output. The highlighted portion of the softkey label indicates where the plot is to be output on the page. This function appears only if two or four plots per page are selected using <b>PLTS/PG 1 2 4</b> .
PLTS/PG 1 2 4	is available for Option 021 or 023 only. <b>PLTS/PG 1 2 4</b> allows you to plot a full-page, half-page, or quarter-page. Selecting two plots per page requires a plotter that has the rotate command (RO). It will be set to a full-page output by <b>DEFAULT CONFIG</b> .
POINT	specifies a limit value for the coordinate point, and no other frequency points, so that a <b>POINT</b> segment specifies a limit value for a single frequency. For an upper limit-line, a <b>POINT</b> segment is indicated by a line drawn from the coordinate point, vertically off the top of screen. For a lower limit-line, a <b>POINT</b> segment is indicated by a line drawn from the coordinate point, vertically off the bottom of screen. The <b>POINT</b> segment type is generally used as the last segment in the limit-line table. However, if the last segment in the table is not of the <b>POINT</b> segment type, an implicit point is automatically added at the right-hand side of the screen. If a visible <b>POINT</b> segment at the right-hand edge of the display is not desired, add an explicit last point segment to the limit-line table that is higher in frequency than the stop frequency.
PRESEL DEFAULT	is available for HP 8593A only. It enables default preselector data for bands 1 through 4 to allow maximum frequency response without peaking the preselector.  To meet the response specifications of Table 1-3, the <b>CAL YTF</b> routine should be performed before using <b>PRESEL DEFAULT</b> .
PRESEL PEAK	is available for HP 8593A only. It optimally centers the preselector on a given signal for the most accurate measurement of amplitude. The maximum

response found for the frequency at the marker determines the future adjustment values provided to the preselector.

**PRESET**

provides a convenient starting point for making most measurements. Pressing **PRESET** displays the operating modes available for your analyzer as softkey functions. (See “Modes” for more information.) See Table 7-6 for the conditions established by pressing **PRESET**.

The **PRESET** key performs a processor test, but does not affect CAL data. **PRESET** clears both the input and output buffers, but does not clear trace B. The amplitude values of trace C are set to the reference level. Amplitude correction factors are turned off. Limit-line testing is turned off, but the limit-line tables remain in analyzer memory. The status byte is set to 0. **PRESET** affects all operating modes. (See “Modes” for more information about other operating modes.)

**PRESET** erases all “on time” functions—ONCYCLE, ONDELAY, ONEOS, ONMKR, ONSRQ, ONSWP, ONTIME, and TRMATH. These are remote programming commands. See *HP 8590 Series Spectrum Analyzer Programming Manual* for more information.

**Note**



Turning the analyzer on performs an instrument preset. In addition to performing an instrument preset, turning on the analyzer fetches **CAL** data, completes a processor test; clears trace B, trace C, and both the input and output buffers; turns off amplitude correction factors; turns off limit-line testing; and sets the status byte to 0. The last state of the analyzer (before it was switched off) is recalled, unless POWERON IP has been executed. See “Changing the Analyzer’s Power-On State” in Chapter 5 for more information.

**Table 7-6. Preset Conditions**

Preset Condition	HP 8591A	HP 8593A
A – B -> A	off	off
Amplitude correction factors	off	off
Amplitude units	default values	default values
Annotation and graticule	on	on
Attenuation	10 dB (auto-coupled)	10 dB (auto-coupled)
Center frequency	900 MHz	12.38 MHz
CF step size	10% of span	10% of span
Coupled functions	all set to AUTO	all set to AUTO
CRD INTRNL	INTRNL	INTRNL
Demodulation	off	off
Detector	positive peak	positive peak
Display line level	2.5 graticule divisions below reference level, display off	2.5 graticule divisions below reference level, display off
Frequency offset	0 Hz	0 Hz
Limit-line testing	off	off
Log scale	10 dB/division	10 dB/division
Marker counter	off	off
Marker counter resolution	auto-coupled	auto-coupled
Markers	off	off

**Table 7-6. Preset Conditions (continued)**

Preset Condition	HP 8591A	HP 8593A
Mixer level	-10 dBm	-10 dBm
Operating mode	spectrum analyzer	spectrum analyzer
Preselector peak	reset	reset
Reference level	0 dBm	0 dBm
Reference level offset	0	0
Resolution bandwidth	3 MHz (auto-coupled)	3 MHz (auto-coupled)
Span	1.8 GHz	19.25 GHz
SRQ mask	octal 50	octal 50
Start frequency	0 Hz	2.75 GHz
Stop frequency	1.8 GHz	22 GHz
State registers 1-8	unaffected	unaffected
Sweep	continuous	continuous
Sweep time	20 ms (auto-coupled)	385 ms, full span (auto-coupled)
Threshold level	one graticule above baseline, display off	one graticule above baseline, display off
Title	cleared	cleared
Trace A	clear-write	clear-write
Trace B	store-blank	store-blank
Trace C	store-blank, at reference level	store-blank, at reference level
Trace registers	unaffected	unaffected
Tracking generator (Option 010 or 011 only)	off	off
Trigger	free run	free run
VBR/RBW ratio	0.3	0.3
Video averaging	off	off
Video bandwidth	1 MHz (auto-coupled)	1 MHz (auto-coupled)

**PRESET SPECTRUM**

allows the spectrum analyzer mode only to be preset; it will not affect the other operating modes. **PRESET SPECTRUM** performs a subset of the following **PRESET** functions:

**Table 7-7. Preset Spectrum Conditions**

Preset Spectrum Condition	HP 8591A	HP 8593A
A - B -> A	off	off
Annotation and graticule	on	on
Center frequency	900 MHz	12.38 MHz
Coupled functions	all set to AUTO	all set to AUTO
Detector	positive peak	positive peak
Display line	off	off
Limit-line testing	off	off
Log scale	10 dB/div	10 dB/div

**Table 7-7. Preset Spectrum Conditions (continued)**

Preset Spectrum Condition	HP 8591A	HP 8593A
Marker counter	off	off
Marker counter resolution	2 kHz (auto-coupled)	2 kHz (auto-coupled)
Markers	off	off
Reference level	0 dBm	0 dBm
Resolution bandwidth	3 MHz	3 MHz
Span	1.8 GHz	19.25 GHz
Start frequency	0 Hz	2.75 GHz
Stop frequency	1.8 GHz	22 GHz
State registers 1—8	unaffected	unaffected
Sweep	continuous	continuous
Sweep time	20 ms	385 ms, full span
Threshold	off	off
Trace A	clear-write	clear write
Trace B	store-blank	store-blank
Trace C	store-blank	store-blank
Trace registers	unaffected	unaffected
Trigger	free	free
Video averaging	off	off
Video bandwidth	1 MHz	1 MHz

In addition, **PRESET SPECTRUM** erases user-generated graphics and blanks the active function block on the analyzer screen. If the analyzer is an HP 8593A, the harmonic band lock is turned off.

**PRESET SPECTRUM** erases **ONEOS**, **ONSWP**, and **TRMATH**. These are remote programming commands; see *HP 8590 Series Spectrum Analyzer Programming Manual* for more information.

**PRINT  
CONFIG**

is available for Option 021 or 023 only. It accesses the softkey functions that address the printer, select from a black and white print or a color print (a color print requires an HP PaintJet printer), and reset the printer. (Option 021 or 023 only.)

**PRINTER  
ADDRESS**

is available for Option 021 only. **PRINTER ADDRESS** allows you to change the HP-IB address of the printer. The printer address is set to 1 by **DEFAULT CONFIG**.

**PRINTER  
SETUP**

is available for Option 021 or 023 only. **PRINTER SETUP** resets the printer, sets the printer to 60 lines per page, and skips line perforations. **PRINTER SETUP** enables you to obtain up to three printouts per page. The printer paper should be at the top of the form before using this function. This function may not work with printers that are not recommended (see "Accessories" in Chapter 1 for recommended printers).

**PRT MENU  
ON OFF**

is available for Option 021 or 023 only. **PRT MENU ON OFF** allows you to print the softkey labels along with the analyzer display when using **(COPY)** in a print configuration. **PRT MENU ON OFF** is set to on with **DEFAULT CONFIG**.

**PURGE  
LIMITS**

clears the limit-line table. Pressing **PURGE LIMITS** causes the message to be displayed **IF YOU ARE SURE, PRESS KEY AGAIN TO PURGE DATA**. Press **PURGE LIMITS** again if you wish to clear the current limit-line table. Use **SAVE LIMIT** if you wish to save the current limit-line table, and then use **NEW LIMIT** or **PURGE LIMITS** to clear the current limit-line table.

**PWR SWP  
ON OFF**

activates (ON) or deactivates (OFF) the power-sweep function, where the output power of the tracking generator is swept over the power-sweep range chosen. The value of the power-sweep range is displayed in the active function block when **PWR SWP ON OFF** is turned on. The available power-sweep range is a function of the **SRC ATN MAN AUTO** setting. **SRC ATN MAN AUTO** must be manually set (decoupled) for power sweeps.

For a given source attenuation setting, the maximum specified power sweep range is given by the following:

Power Sweep Range = (-15 dBm minus source attenuation setting) to (0 dBm minus source attenuation setting).

For example, if the source attenuation setting is 20 dB, the maximum power sweep range is from -35 dBm (-15 dBm - 20 dB) to -20 dBm (0 dBm - 20 dB). The starting power level is the source power setting. The ending power level is the sum of the source power setting plus the source power sweep setting. Source power sweep may be set as high as 20 dB, but performance is specified only up to 15 dB.

The output power of the tracking generator is swept according to the sweep rate of the spectrum analyzer. The output power is always swept from the source power setting to a higher power setting (negative source power sweep values are not allowed). Refer to Table 1-2 for more information regarding source power and source attenuation relationships.

Power-sweep measurements are particularly useful in making gain compression or output power versus frequency measurements.

**RECALL**

accesses softkey menus that allow you to recall data from the memory card or analyzer memory. When **INTRNL** is selected, states, traces, limit-line tables, amplitude correction factor can be recalled from analyzer memory. When **CRD** is selected, states, traces, limit-line tables, and amplitude correction factors, and downloadable programs can be recalled from the memory card.

In addition, **RECALL** accesses the cataloging functions to catalog the saved data in analyzer memory or the memory card.

**RECALL  
LIMIT**

recalls limit-line table(s) from the current mass storage device (analyzer memory or memory card). To verify the current mass storage device, press **RECALL LIMIT**. If **MAX REG #** appears on the analyzer display, the current mass storage device is analyzer memory. If **PREFIX=** is displayed, the memory card is the mass storage device. Press **SAVE** or **RECALL**, **INTRNL CRD** to change the current mass storage device. To recall a limit line, enter the register number the limit-line table(s) was saved under, then press **ENTER**. When recalling a limit line from the memory card, it may be necessary the change the current prefix to the prefix with which the limit line was stored.

Use **CHANGE PREFIX** to change the current prefix. When saved in analyzer memory, the register number is restricted to 0 and the number indicated by **MAX REG # =**. The screen title is not recalled with the limit-line tables.

---

**Note**

The upper limit-line is stored in trace B and the lower limit-line is stored in trace C. When saving or recalling limit lines, both the upper and lower limit-lines are saved or recalled, regardless of the status of trace B and trace C.

---

- REF LVL** is activated when **AMPLITUDE** is pressed. The reference level is the amplitude power or voltage represented by the top graticule line on the screen. Changing the value of the reference level changes the absolute amplitude level (in dBm) of the top graticule line.
- REF LVL OFFSET** adds an offset value to the displayed reference level. Offsets are entered with the number/units keypad. Entering an offset does not affect the trace or the attenuation value. Reference level offsets are used when gain or loss occurs between a device under test and the spectrum analyzer input. Thus, the signal level measured by the analyzer is the level at the input of an external amplitude conversion device. When an amplitude offset is entered, its value is displayed on the left side of the screen (as opposed to frequency offsets which are displayed at the bottom of the screen). To eliminate an offset, press **REF LVL OFFSET**, 0 **-dBm** or **+dBm**. **PRESET** also sets the offset to zero. Reference level offsets are entered using the numeric keypad. See also "PREAMP GAIN."
- RES BW AUTO MAN** changes the analyzer's 3 dB IF bandwidth to 1 kHz, 3 kHz, 10 kHz, 30 kHz, 100 kHz, 300 kHz, 1 MHz, 3 MHz, or 5 MHz. As the **RES BW** is decreased, the sweep time is increased to maintain amplitude calibration. To indicate that it is not coupled, a "#" mark appears next to **RES BW** on the screen. To recouple the **RES BW**, press **RES BW AUTO MAN** so that **AUTO** is underlined. The resolution bandwidth can be changed using the step keys, the knob, or the numeric keypad.
- RPG TITLE** provides additional characters for **CHANGE TITLE**. **RPG TITLE** provides lowercase letters, numbers, Greek letters, and punctuation symbols. To access these additional characters, press **RPG TITLE**. When **RPG TITLE** is pressed, a character table appears on the screen. To select a character, turn the rotary-pulse generator (RPG) knob to position the cursor under the desired character and press the **ENTER** key. The step keys move the cursor between rows. When all characters have been entered, press **HOLD**. All other analyzer functions are inoperative until **HOLD** is pressed.
- SAVE** accesses softkey menus that allow you to store state data, trace data, limit-line tables, and amplitude correction factors in analyzer memory; state data, trace data, limit-line tables, amplitude correction factors, and program data are saved on the memory card. In addition, **SAVE** accesses the softkey menus to catalog the saved data in the analyzer memory or the memory card. To select saving or cataloging analyzer memory, press **INTRNL CRD** so that **INTRNL** is underlined. To save to or catalog from the memory card, press **INTRNL CRD** so that **CRD** is underlined.

Saving state data saves the analyzer settings (but not the trace data). Saving trace data saves the trace data and the state data. Programs (also called downloadable programs or DLPs), can only be saved to or recalled from the memory card.

States and traces are saved in analyzer memory even if the instrument is turned off or **PRESET** is pressed. Eight analyzer memory state registers and many trace registers are available for the user.

**SAVE  
LIMIT**

saves the current limit-line table(s) in the current mass storage device (analyzer memory or memory card). To verify the current mass storage device, press **SAVE LIMIT**. If **MAX REG #** appears on the analyzer display, the current mass storage device is analyzer memory. If **PREFIX=** is displayed, the memory card is the mass storage device. Press **SAVE** or **RECALL**, **INTRNL CRD** to change the current mass storage device. Press **SAVE LIMIT**, enter a register number, then press **ENTER** to save the current limit-line table in analyzer memory or on the memory card. When saved on the memory card, limit-line tables are stored with "1\_", the prefix, and the register number entered. When saved in analyzer memory, the register number is saved in a trace register. Trace register values are restricted to 0 and the number indicated by **MAX REG # =**.

**Note**



The upper limit-line is stored in trace B and the lower limit-line is stored in trace C. When saving or recalling limit lines, both the upper and lower limit-lines are saved or recalled, regardless of the status of trace B and trace C.

**SAV LOCK  
ON OFF**

locks all the current internal state and trace registers against further data storage, when **ON** is underlined. With the state and trace memory locked, **STATE -> INTRNL**, and **TRACE -> INTRNL** functions are no longer accessible; **MEM LOCKED** is displayed instead. **SAV LOCK ON OFF** is set to off by **DEFAULT CONFIG** and **PRESET**.

**Note**



When **SAV LOCK ON OFF** is on, none of the state registers can be overwritten, including state register nine. The analyzer automatically updates state register nine with the last state unless **SAV LOCK ON OFF** is on.

**SCALE  
LOG LIN**

scales the vertical graticule divisions in logarithmic units when **LOG** is underlined. When **SCALE LOG LIN** is the active function, the logarithmic units per division can be changed. Values may range from 1 to 20 dB per division. When **LIN** is underlined, the vertical scale is in linear mode. The reference level value is set to the top of the screen and the bottom graticule becomes zero volts. (Each division of the graticule is one-eighth of the reference level in volts.)

Pressing **SCALE LOG LIN** always sets the units specified for the current amplitude scale. Pressing **PRESET** or powering on the analyzer sets the default units.



**SECAM-L** is available if Options 101 and 102 are installed. It triggers on the SECAM-L video formats. **SECAM-L** alters the TV line number the analyzer triggers on internally; the line number displayed by **TV LINE #** does not change. **SECAM-L** changes the video modulation to positive; use **TV SYNC NEG POS (NEG)** if negative video modulation is required.

**SELECT AMPLITUDE** allows you to enter the amplitude value for the displayed (upper or lower) limit-line segment. Enter the amplitude value for the frequency using the knob or data keys of the analyzer. Use **(BK SP)** to correct errors.

**SELECT DLT AMPL** allows you to enter the delta amplitude value. The middle amplitude value and the delta amplitude value create an upper and lower limit-line segment. Enter the delta amplitude value for the frequency using the knob or data keys of the analyzer. Use **(BK SP)** to correct errors. The default value is 0.

**SELECT FREQ** allows you to enter the frequency value for a limit-line segment. Enter the frequency value for the frequency using the knob or data keys of the analyzer. Use **(BK SP)** to correct errors. Regardless of the table format, a frequency coordinate must be specified.

---

**Note**



There can be only one entry per frequency. Entering two segments with the same frequency in the same limit-line table is not allowed.

Limit-line data is sorted in frequency order in the limit-line table. The sorting occurs after you have entered the frequency and at least one amplitude value.

---

**SELECT LWR AMPL** allows you to enter the amplitude value for the lower limit-line segment. Enter the amplitude value for the frequency using the knob or data keys of the analyzer. Use **(BK SP)** to correct errors.

**SELECT MID AMPL** allows you to enter the middle amplitude value. The middle amplitude value and the delta amplitude value create upper and lower limit-line segments. Enter the amplitude value for the frequency using the knob or data keys of the analyzer. Use **(BK SP)** to correct errors.

**SELECT SEGMENT** allows you to create or edit a limit-line segment. Limit lines are created by entering frequency and amplitude values into a limit-line table. The frequency and amplitude values specify a coordinate point from which a limit-line segment is drawn. The coordinate point is the lowest frequency point of the line segment. Limit lines are constructed from left to right. To select a segment, press **SELECT SEGMENT**, the segment number you wish to specify, then a units key.

Up to 20 segments can be specified per limit-line table.

**SELECT TYPE** accesses the softkey menu to select the type of line—a flat line (**FLAT**), a sloped line (**SLOPE**), or a point (**POINT**).

**SELECT UPR AMPL** allows you to enter the amplitude value for the upper limit-line segment. Enter the amplitude value for the frequency using the knob or data keys of the analyzer. Use **(BK SP)** to correct errors.

**SERVICE  
CAL**

accesses several service calibration functions. The service calibration functions are designed for service use only. Descriptions of the service functions are available in the service documentation. You can order the service documentation, HP 8591A Option 915 or HP 8593A Option 915, through your HP Sales and Service office. The package is described under "Service Documentation for the HP 8591A (Option 915)" or "Service Documentation for the HP 8593A (Option 915)" in Chapter 1 of this manual.

**SET ATTN  
ERROR**

sets the calibration attenuator error factors (this is not the same as the input attenuator). This is a service calibration function and designed for service use only.

**SET  
DATE**

sets the date of the real-time clock. Enter the date in the YYMMDD format using the number keypad and press **ENTER**. Valid year (YY) values are 00 through 99. Valid month (MM) values are from 01 to 12, and valid day values are from 01 to 31.

**SET  
TIME**

sets the time of the real-time clock. Enter the time in 24 hour, HHMMSS format, using the number keypad and enter the time by pressing **ENTER**. Valid hour (HH) values are from 00 to 23. Valid minute (MM) and second (SS) values are from 00 to 59.

**SGL SWP**

changes the sweep control to single sweep if the analyzer is in the continuous sweep mode. It sets up a sweep for the trigger conditions.

**SHOW  
OPTIONS**

displays the number and description of the option(s) installed in your analyzer, the model number of the analyzer, and the last five digits of the analyzer's serial number. **SHOW OPTIONS** does not display the option number or description of Option 026. Pressing **SHOW OPTIONS** changes the softkey label to **EXIT SHOW**. Press **EXIT SHOW** to erase **SHOW OPTIONS** information.

**SIGNAL TRACK**

moves the signal nearest to the active marker to the center of the screen and fixes the signal there. **MKR-TRK** or **CNTR-TRK** appears in the upper-right corner of the display.

**SIGNAL TRACK**, **PRESET**, **MARKER NORMAL**, or **MARKERS OFF** turn the signal track function off.

When signal track is on and the span is reduced, an automatic zoom is performed: the span is reduced in steps so that the signal remains at the center of the screen. If the span is zero, signal track cannot be activated.

**SLOPE**

draws a straight line between the coordinate point of the current segment and the coordinate point of the next segment, producing limit-line values for all frequencies between the two points.

**SPAN** or **SPAN**

**SPAN** activates **SPAN** and accesses the frequency span functions. **SPAN** changes the frequency range symmetrically about the center frequency. The frequency span readout describes the total displayed frequency range; to determine frequency span per horizontal graticule division, divide the frequency span by 10.

SPAN ZOOM	finds the highest signal peak on-screen (if an on-screen marker is not present), places a marker on it, turns on the signal track function, and activates the span function. <b>SPAN ZOOM</b> performs the following routine: <b>PEAK SEARCH</b> , <b>SIGNAL TRACK</b> , <b>SPAN</b> .
SPEAKER ON OFF	is available with Option 102. It turns the internal speaker on or off. The volume from the speaker is controlled by the front-panel volume control knob and <b>FM GAIN</b> (when using FM demodulation). There is no output from the speaker unless demodulation is turned on. <b>PRESET</b> sets <b>SPEAKER ON OFF</b> to ON.
SPECTRUM ANALYZER	sets the analyzer to the spectrum analyzer operating mode and accesses a softkey function, <b>PRESET SPECTRUM</b> .
SQUELCH	is available with Option 102. It adjusts the squelch level. The squelch level mutes weak signals and passes strong signals. The squelch level affects the audio output only. If the internal speaker is on, audio signals are not output unless the signal strength exceeds the squelch threshold. The squelch level does not affect the rear-panel <b>AUX VIDEO OUT</b> signal. Squelch level is indicated on-screen by the unitless numbers 0 to 100, with 0 being minimum squelch threshold (all signals are passed), and 100 being maximum squelch threshold (no signals are passed). The default squelch value is 0.
SRC ATN MAN AUTO	allows manual adjustment of the tracking generator's switching attenuator. It can be adjusted from 0 to 60 dB in 10 dB steps. When auto-coupled, <b>SRC ATN MAN AUTO</b> automatically adjusts the attenuator to yield the source amplitude level specified by <b>SRC PWR ON OFF</b> . <b>SRC ATN MAN AUTO</b> must be manually set (decoupled) for power sweeps greater than 10 dB.
SRC PWR OFFSET	offsets the displayed power of the source (SRC), the tracking generator. Offset values may range from -100 dB to +100 dB.  Using the source-power-offset capability of the tracking generator allows you to take system losses or gains into account, thereby displaying the actual power delivered to the device under test.
SRC PWR ON OFF	is available for HP 8591A with Option 010 or 011 only. <b>SRC PWR ON OFF</b> activates (ON) or deactivates (OFF) the output power of the source (SRC), the tracking generator. The power level can then be adjusted using the data keys, step keys, or knob. The specified output power level is -75 to 0 dBm (50Ω), and -27.2 dBmV to +42.8 dBmV (75Ω), with 0.1 dB resolution.
SRC PWR STP SIZE	allows the user to set the step size of the source power level, source power offset, and power-sweep range functions. The step size may be values from -32.7 dB to 32.7 dB. Default is one vertical scale division.
START FREQ	sets the frequency at the left side of the graticule. The left and right sides of the graticule sides correspond to the start and stop frequencies. When these frequencies are activated, their values are displayed below the graticule in place of center frequency and span.

STATE -> CARD	saves the current analyzer state on the memory card. To save the current state, press <b>STATE -&gt; CARD</b> , use the numeric keypad to enter a number, and press <b>ENTER</b> . If you want the file name of the stored data to contain a prefix, use <b>CHANGE PREFIX</b> to enter a prefix before storing the data. If the state data was stored using a prefix, the file name for the state data consists of s(prefix).(register number). If no prefix was specified, the file name is s_(register number).
STATE -> INTRNL	saves the current analyzer state in the selected state register. To save the current state, press <b>STATE -&gt; INTRNL</b> , and use the numeric keypad to enter a state register number (valid state register numbers are 1 through 8).
STOP FREQ	sets the frequency at the right side of the graticule. The left and right sides of the graticule sides correspond to the start and stop frequencies. When these frequencies are activated, their values are displayed below the graticule in place of center frequency and span.
STUVWX	accesses the softkey menu for selecting screen title or prefix characters S through X.
<b>SWEEP</b>	accesses the functions that control the sweep time and the sweep control: <b>SWP TIME AUTO MAN</b> and <b>SWEEP CONT SGL</b> .
SWEEP CONT SGL	switches the analyzer between the continuous sweep mode and the single sweep mode. If the analyzer is in the single sweep mode, SGL is underlined. Use <b>SGL SWP</b> to enable a sweep when in single-sweep mode. When continuous-sweep mode is in use, one sweep follows another as soon as it is triggered. <b>PRESET</b> , power on, and <b>PRESET SPECTRUM</b> select continuous sweep.
SWP CPLG SR SA	selects stimulus-response (SR) or spectrum-analyzer (SA) auto-coupled sweep time. In stimulus-response mode, auto-coupled sweep times are usually much faster for swept-response measurements. Stimulus-response auto-coupled sweep times are typically valid in stimulus-response measurements when the system's frequency span is less than 20 times the bandwidth of the device under test.
SWP TIME AUTO MAN	selects the length of time in which the analyzer sweeps the displayed frequency span. In all nonzero frequency spans, the sweep time varies from 20 milliseconds to 100 seconds. In zero frequency span, the fastest sweep time is 15 milliseconds. Reducing the sweep time increases the rate of sweeps. The sweep time can be changed using the step keys, the knob, or the numeric keypad.  <i>For Option 101 only:</i> Option 101 provides sweep times from 20 $\mu$ s to 100 seconds in zero span. Fast zero span sweeps are digitized.

**THRESHLD ON OFF** sets a lower boundary to the active trace. The threshold line “clips” signals that appear below the line when on. The boundary is defined in amplitude units that correspond to its vertical position when compared to the reference level.

The value of the threshold appears in the active function block and on the lower-left side of the screen. The threshold level does not influence the trace memory or marker position. The peaks found by the markers must be the peak excursion value above the threshold level. The value of the threshold level can be changed using the step keys, the knob, or the numeric keypad.

If a threshold is active, press **THRESHLD ON OFF** to turn the threshold display off. The threshold value affects peak searching even when **THRESHLD ON OFF** is off.

**TIMEDATE** accesses the softkey menu to set and display the real-time clock.

**TIMEDATE ON OFF** turns the display of the real-time clock on and off. **TIMEDATE ON OFF** will be set to on by **DEFAULT CONFIG**.

**TRACE** accesses the trace softkeys that allow you to store and manipulate trace information. Each trace is comprised of a series of data points that form a register where amplitude information is stored. The analyzer updates the information for any active trace with each sweep. If two traces are being written to, they are updated on alternating sweeps. (Also see “Screen Annotation” in Chapter 5.)

**TRACE A** sets up trace A for recalling previously saved trace data into trace A or saving trace data from trace A.

**TRACE A B C** selects the softkey menu for trace A, trace B, or trace C functions. Press **TRACE A B C** until the letter of the desired trace is underlined.

**TRACE B** sets up trace B for recalling previously saved trace data into trace B or saving trace data from trace B.

**TRACE C** sets up trace C for recalling previously saved trace data into trace C or saving trace data from trace C.

**TRACE -> CARD** begins the process to save trace data, limit-line tables, or amplitude correction factors on the memory card. Pressing **TRACE -> CARD** accesses a softkey menu which allows you to select the trace to be saved (trace A, trace B, or trace C), **LIMIT LINES**, or **AMPLTUD COR FACT**. To save a trace, press **TRACE A**, **TRACE B**, or **TRACE C**, use the numeric keypad to enter a trace register number, and press **ENTER**. To save limit-line tables or amplitude correction factors, press **LIMIT LINES** or **AMPLTUD COR FACT**, use the numeric keypad to enter a trace register number, and press **ENTER**. If you want the file name of the stored data to contain a prefix, use **CHANGE PREFIX** to enter a prefix before storing the data. If the trace data was stored using a prefix, the file name is t(prefix)-(register number). If no prefix was available, the data is stored under t-(register number). File names for limit-line tables and amplitude correction factors are treated the same way as file names for trace data, except “l” or “a” is used instead of “t.” If a screen title is present,

it is saved with the trace data. The time and date that the data was stored is appended to the screen title.

TRACE  
-> INTRNL

accesses a softkey menu which allows you to select the item to be stored in analyzer memory: the trace to be saved (trace A, trace B, or trace C), limit-line tables, or amplitude correction factors. To save a trace, select the trace to be saved, enter the trace register number and press **ENTER**. To save limit-line table(s) or amplitude correction factors, press **LIMIT LINES** (to save limit-line tables) or **AMPLTUD COR FACT** (to save amplitude correction factors), enter the trace register number and press **ENTER**. Valid trace registers numbers are 0 through the maximum register number. The maximum register number is the number displayed after **MAX REG #** = during a save or recall operation. If a screen title is present, it is saved with the trace data. The time and date that the trace was stored is appended to the screen title.

TRACK  
GEN

is available for HP 8591A with Option 010 or 011 only. **TRACK GEN** displays softkey menus for use with a built-in tracking generator.

TRACKING  
PEAK

is available for HP 8591A with Option 010 or 011 only. **TRACKING PEAK** activates a routine which automatically adjusts the tracking adjustment to obtain the peak response of the tracking generator on the spectrum-analyzer display.

---

**Note**



The tracking generator must be connected to the spectrum analyzer in order for tracking peak to function properly.

Before making a stimulus-response measurement, care must be taken to maximize the tracking adjustment of the tracking generator to ensure amplitude accuracy.

---

**TRIG**

accesses softkeys that let you select the sweep mode and trigger mode. (Also see "Screen Annotation" in Chapter 5.)

---

**Note**



With some delayed trigger functions (for example, external or TV triggering), the softkey menu is not updated until after the trigger has occurred.

---

TV  
LINE #

is available if Options 101 and 102 are installed. It selects the line number of the video picture field. The values allowed are 1 to 1012. **PRESET** sets the TV line number to 17.

TVSTND

is available if Options 101 and 102 are installed. It allows the analyzer to trigger on NTSC, PAL, PAL-M, or SECAM-L video formats.

TV SYNC  
NEG POS

is available if Options 101 and 102 are installed. It selects the polarity of the modulation of the video format. NTSC uses the negative or positive modulation video format. NTSC, PAL, PAL-M use negative modulation, SECAM-L uses positive modulation.

<b>TV TRIG</b>	is available if Options 101 and 102 are installed. It provides sweep triggering on the selected line of a video picture field and accesses the softkey menu to select the line number of the video picture field, and the type of video picture frame.  When <b>TV TRIG</b> is pressed, the trigger mode is changed to TV trigger, the <b>TV LINE #</b> number becomes the active function, and the softkey menu for the changing the TV line numbers and video field trigger is accessed.  If the analyzer is in nonzero span, resolution bandwidth is changed to 1 MHz, frequency span is set to 0 Hz, the detector mode is changed to sample, the sweep time is changed to 100 $\mu$ s, the amplitude scale is changed to linear, a sweep is taken, and a marker is placed on the signal peak.
<b>TV TRIG EVEN FLD</b>	is available if Options 101 and 102 are installed. It selects an even video field of an interlaced video format to trigger on.
<b>TV TRIG ODD FLD</b>	is available if Options 101 and 102 are installed. It selects an odd video field of an interlaced video format to trigger on.
<b>TV TRIG VERT INT</b>	is available if Options 101 and 102 are installed. <b>TV TRIG VERT INT</b> selects a vertical interval to trigger on. Triggering occurs on the next pulse edge. If it triggers on an even field, triggering will not alternate between odd and even fields. If it triggers on an odd field, triggering will alternate between odd and even fields. The vertical interval is used for noninterlaced video formats.
<b>USER MENU(S)</b>	accesses a menu available for your use for user-defined programs and key functions.
<b>VBW/RBW RATIO</b>	selects the ratio between the video and resolution bandwidths. If signal responses near the noise level are visually masked by the noise, the ratio can be set to less than 1 to smooth this noise. The knob and step keys change the ratio in a 1, 3, 10 sequence. <b>PRESET</b> and <b>AUTO ALL</b> sets the ratio to 0.300 X. The ratio can be changed using the step keys or the knob.
<b>VERIFY TIMEBASE</b>	verifies that the time base digital-to-analog converter is operational. This function cannot be accessed without a pass code. <b>VERIFY TIMEBASE</b> is reset with <b>PRESET</b> .
<b>VID AVG ON OFF</b>	initiates a digital averaging routine that averages displayed signals and noise. It does not affect the sweep time, bandwidth, or other analog characteristics of the analyzer. Annotation on the left side of the screen indicates the current number of sweeps averaged. The default number of sweeps is 100. Increasing the number of sweeps smooths the trace. To turn off the video averaging function, press <b>VID AVG ON OFF</b> so that <b>OFF</b> is underlined. The number of sweeps can be entered with the numeric keypad.
<b>VID BW AUTO MAN</b>	changes the analyzer's post-detection filter from 30 Hz to 3 MHz in a 1, 3, 10 sequence.  As the video bandwidth is decreased, the sweep time is increased to maintain amplitude calibration. To indicate that it is not coupled, a “#” mark appears next to <b>VBW</b> displayed on the bottom of the analyzer screen. To couple the <b>VID BW</b> , press <b>VID BW AUTO MAN</b> so that <b>AUTO</b> is underlined.

---

**Note**

Coupling **VID BW AUTO MAN** also couples **VBW/RBW RATIO** . If you want to auto-couple the video bandwidth to a nonstandard ratio, you must set the video bandwidth to auto-couple before setting the video-bandwidth/resolution-bandwidth ratio.

---

	The video bandwidth can be changed using the step keys, the knob, or the numeric keypad.
<b>VIDEO</b>	activates the trigger condition that allows the next sweep to start if the detected RF envelope voltage rises to a level set by the display line. When <b>VIDEO</b> is pressed, the display line appears on the screen. For example, connect the <b>CAL OUT</b> signal to the analyzer input, change the trigger mode to video, and lower the display line. The analyzer triggers when the display line reaches the noise floor.
<b>VIEW A</b>	holds and displays the amplitude data in the trace A register. The trace A register is not updated as the analyzer sweeps. If trace A is deactivated with <b>STORE BLANK A</b> , the stored data can be retrieved with <b>VIEW A</b> .
<b>VIEW B</b>	holds and displays the amplitude data in the trace B register. The trace B register is not updated as the analyzer sweeps. If trace B is deactivated with <b>STORE BLANK B</b> , the stored data can be retrieved with <b>VIEW B</b> .
<b>VIEW C</b>	holds and displays the amplitude data in the trace C register. The trace C register is not updated as the analyzer sweeps. If trace C is deactivated with <b>STORE BLANK C</b> , the stored data can be retrieved with <b>VIEW C</b> .
<b>Volts</b>	changes the amplitude units to volts for the current setting (log or linear).
<b>Watts</b>	changes the amplitude units to watts for the current setting (log or linear).
<b>YZ_# SPC CLEAR</b>	accesses the softkey menu for selecting the characters Y, Z, underscore ( - ), #, space, or for clearing the screen title.
<b>ZERO SPAN</b>	changes the frequency span to zero and turns off signal track if it is on.



---

## Data Controls

Data controls are used to change values for functions such as center frequency, start frequency, resolution bandwidth, and marker position.

The data controls will change the active function in a manner prescribed by that function. For example, you can change center frequency in fine steps with the knob, in discrete steps with the step keys, or to an exact value with the number/units keypad. For example, resolution bandwidth, which can be set to discrete values only, is changed to predetermined values with any of the data controls.

### Hold Key

Deactivate functions with the **HOLD** key. The active function readout is blanked, indicating that no entry will be made inadvertently by using the knob, step keys, or keypad. (Pressing a function key reenables the data controls.)

### Knob

The knob allows continuous change of functions such as center frequency, reference level, and marker position. It also changes the values of many functions that change in increments only.

Clockwise rotation of the knob increases values. For continuous changes, the extent of alteration is determined by the size of the measurement range; the speed at which the knob is turned does not affect the rate at which the values are changed.

The knob enables you to change the center frequency, start or stop frequency, or reference level in smooth scrolling action. The smooth scrolling feature is designed to move the trace display to the latest function value as the knob is turned. When center frequency or reference level is adjusted, the signal will shift right or left or up or down with the rotation of the knob before a new sweep is actually taken. An asterisk is placed in the message block (the upper right-hand corner of the analyzer display) to indicate that the data on-screen does not reflect data at the current setting.

---

### Note



When using the knob to change frequency or amplitude settings, the trace data is shifted. Therefore, when using **MAX HOLD A**, **MAX HOLD B**, or **MIN HOLD C**, moving the center frequency with the knob will not simulate a drifting signal.

---

### Number/Units Keypad

The number/units keypad allows entry of exact values for many of the analyzer functions. You may include a decimal point in the number portion. If not, the decimal point is placed at the end of the number.

Numeric entries must be terminated with a unit key. The unit keys change the active function in a manner prescribed by that function. For example, the units keys for frequency span are **GHz**, **MHz**, **kHz**, **Hz**, whereas the units for reference level are **+dBm**, **-dBm**, **mV**, **μV**.

---

**Note**

If an entry from the number/units keypad does not coincide with an allowed function value (for example, that of a 12 MHz bandwidth), the analyzer defaults to the nearest allowable value.

---

**Step Keys**

The step keys allow discrete increases or decreases of the active function value. The step size depends upon the analyzer's measurement range or on a preset amount. Each press results in a single step change. For those parameters with fixed values, the next value in a sequence is selected each time a step key is pressed. Changes are predictable and can be set for some functions. Out-of-range values or out-of-sequence values will not occur using these keys.

---

**Front-Panel Controls and Fine-Focus Control****Front-Panel Controls****VOL-INTEN**

The intensity knob allows you to change the brightness of the writing on the screen or change the volume from the internal speaker (available with Option 102 only).

**Line Power**

**LINE** turns on the instrument and starts an instrument check. After applying power, allow the temperature of the instrument to stabilize for best measurement results.

---

**Note**

The instrument draws power when it is plugged into the ac power line, even if the line power switch is off.

---

**Fine Focus Control**

The fine-focus control is located on the side of the analyzer. To adjust the fine-focus control:

1. Adjust the front-panel intensity control for a comfortable viewing intensity.
2. Use an adjustment tool or small screwdriver to access the fine-focus adjustment. See Figure 7-4. Adjust for a focused display.

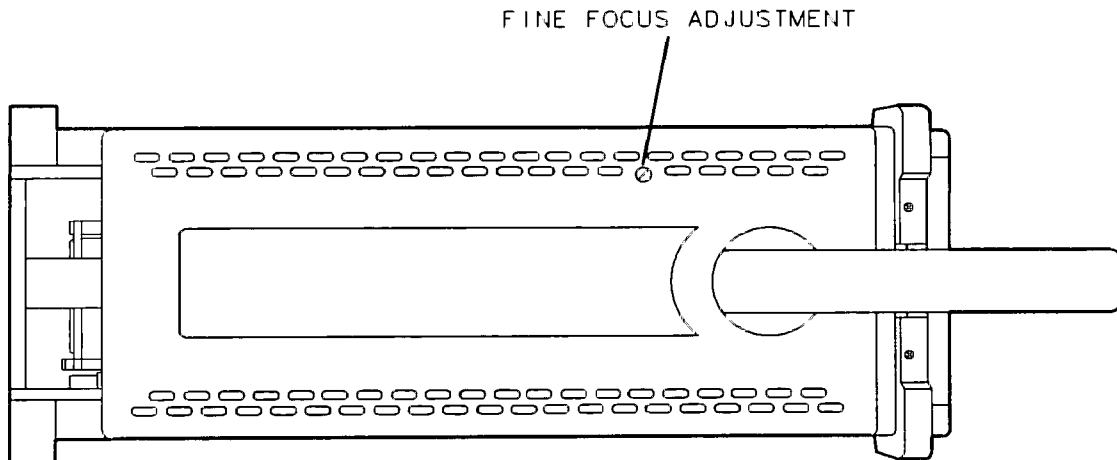

**Figure 7-4. Adjusting the Fine Focus**

---

## Front-Panel Connectors

### 100 MHz COMB OUT

is available for HP 8593A only. It supplies a 100 MHz signal with harmonics up to 22 GHz for use as a reference signal. 100 MHz COMB OUT is connected to the analyzer input during CAL YTF.

### CAL OUT

provides the calibration signal of 300 MHz at  $-20$  dBm (29 dBmV for Option 001 or 011). It is connected to the analyzer input during amplitude and frequency self-calibration routines. (See "Improving Accuracy with Self-Calibration Routines.")

### INPUT 50 $\Omega$

is the signal input for the spectrum analyzer. It has a 50 $\Omega$  impedance (or 75 $\Omega$  impedance for Option 001).

---

### Caution



Since the male center pin of a 50 $\Omega$  connector is larger than the center pin of a 75 $\Omega$  connector, connecting a 50 $\Omega$  connector to the input of an HP 8591A Option 001 could damage the Option 001 input connector. Do not connect a 50 $\Omega$  connector directly to the Option 001 input connector.

---

### Caution



Excessive signal input power will damage the analyzer input attenuator and the input mixer. Use extreme caution when using the spectrum analyzer around high-power RF sources and transmitters. The spectrum analyzer's maximum total input power rating should not be exceeded.

---

### PROBE POWER

provides power for high-impedance ac probes and certain other accessories.

---

**Caution**

The tracking generator output may damage the device under test. Do not exceed the maximum power that the device under test can tolerate.

---

**RF OUT 50 $\Omega$** 

supplies 100 kHz to 1.8 GHz the output for the built-in tracking generator (available with Option 010 for the HP 8591A only). (RF OUT 75 $\Omega$  is the 1 MHz to 1.8 GHz tracking generator output for Option 011.)

---

## Rear-Panel Connectors

The rear panel of your instrument may contain the following connectors, depending on the options ordered with the instrument.

See Chapter 1, "Options and Accessories Available," for more information on options.

<b>LO OUTPUT</b>	is not available.
<b>EARPHONE</b>	provides a connection for an earphone jack instead of using the internal speaker (for Option 102 or 301).
<b>10 MHz REF OUTPUT</b>	provides a 10 MHz, 0 dBm minimum, time-base reference signal.
<b>EXT REF IN</b>	accepts an external frequency source of 10 MHz, -2 to 10 dBm, as the frequency reference.
<b>SWEEP + TUNE OUTPUT</b>	is not available.
<b>VOLTAGE SELECTOR</b>	adapts the unit to the power source: 115 V or 230 V.
<b>Power input</b>	is the input for the main power cable. Insert the main power cable plug only into a socket outlet that has a protective ground contact.
<b>MONITOR OUTPUT</b>	drives an external CRT monitor, such as the HP 82913A, with a 19.2 kHz horizontal synchronizing rate.
<b>AUX INTERFACE</b>	provides a nine-pin "D" subminiature connector with four output lines and one input line. See Table 1-2 or Table 1-4 for a detailed description.

---

**Caution**

Do not use the AUX INTERFACE as a video monitor interface. Damage to the video monitor will result.

---

- Interface connectors** are optional interfaces for HP-IB and RS-232 interface buses that allow remote instrument operation and direct plotting or printing of screen data.
- AUX IF OUTPUT** is a 50Ω, 21.4-MHz IF uncorrected output that is the down-converted signal from the RF input of the analyzer. Output bandwidth is controlled by the spectrum-analyzer resolution-bandwidth setting. Output amplitude is controlled by input attenuation and reference level. Output level is approximately -10 dBm into 50Ω with a signal displayed at the reference level.
- AUX VIDEO OUTPUT** provides detected, uncorrected video output (before analog-to-digital conversion) proportional to vertical deflection of the CRT trace. Output voltage is from 0 to 1 V. Amplitude corrections are not applied to this output.
- EXT TRIG INPUT (TTL)** triggers the analyzer's internal sweep source using the positive edge of an external voltage.
- HI SWEEP IN/OUT** indicates sweep or can be grounded to stop sweep.
- Input: accepts input signal from open collector circuit. Use low input to stop sweep; otherwise leave open.
- Output: high TTL indicates sweep; low TTL indicates retrace.
- EXT KEYBOARD** provides an optional interface connector.

---

**Caution**



The analyzer *must* be turned off before connecting an external keyboard to the analyzer. Failure to do so may result in loss of factory correction constants.

---

This allows screen titles to be entered using an external keyboard. The function keys of the external keyboard control the analyzer as follows:

**Table 7-8. Functions of the External Keyboard Keys**

Key	Description
F1—F6	Softkeys 1 through 6 (respectively) of the current analyzer menu.
F7	Enter prefix mode.
F8	Enter remote commands mode.
F9	Accesses the <b>FREQUENCY</b> menu.
F10	Accesses the <b>SPAN</b> menu.
F11	Accesses the <b>AMPLITUDE</b> menu.
F12	Retrieves the present screen title for editing.

**Table 7-8. Functions of the External Keyboard Keys (continued)**

Key	Description
<b>ESC</b>	Returns to the enter title mode.
<b>PRINT SCREEN</b>	Copies the analyzer screen display to the active copy device.
<b>DELETE</b>	Deletes the character over the cursor
<b>ALT-DELETE</b> *	Clears the keyboard line.
<b>CTRL-DELETE</b> *	Clears to end of line.
<b>←</b>	Moves the cursor to the left.
<b>→</b>	Moves the cursor to the right.
<b>▼</b>	Moves from later items to earlier items in the recall buffer.
<b>▲</b>	Moves from earlier items to later items in the recall buffer.
<b>CTRL-C</b> *	End-of-text
<b>CTRL-J</b> *	Line feed.
<b>CTRL-M</b> *	Carriage return.
<b>CTRL-N</b> *	Turns on inverse video.
<b>CTRL-O</b> *	Turns enhancements (inverse video, underlining) off.
<b>CTRL-P</b> *	Turns off underlining.
<b>CTRL-[]</b> *	Escape.
*The dash between keys indicates that both keys should be pressed at the same time.	

The external keyboard operation with the analyzer is similar to its operation with a computer except for the following:

SCROLL LOCK and NUM LOCK are fixed and cannot be changed. Pressing **NUM LOCK** displays the keyboard mode on the analyzer screen. The analyzer will not recognize the control characters or function keys.

The keyboard supports a 244 character recall buffer. The longest single item is limited to 243 characters; subsequent characters are ignored. Using the **▲** or **▼** keys of the external keyboard to recall an item does not change the buffer contents. Recalling an item and then pressing the **ENTER** key does not store a new copy of the item in the recall buffer. If an item is recalled and then modified, a new copy will be made in the recall buffer. Adding new data into the keyboard line deletes the oldest data automatically.

When in command mode, the active line will append a semicolon to the keyboard entry if the line does not end with a semicolon and it is fewer than 243 characters long.

- LEVELING INPUT** allows the use of an external positive- or negative-polarity detector or power meter for automatic leveling control of the tracking generator. (HP 8591A Option 010 or 011 only.)
- SWEEP OUTPUT** provides a voltage ramp proportional to the sweep and the analyzer span (0 to 10 V).
- TV TRIG OUTPUT (TTL)** provides TV trigger output using TTL and negative edge triggering. (Available with Options 101 and 102 only.)





## Problems

---

### What You'll Find in This Chapter

Your spectrum analyzer is built to provide dependable service. It is unlikely that you will experience a problem with the HP 8591A or HP 8593A. However, if you do, or if you desire additional information or wish to order parts, options, or accessories, Hewlett-Packard's worldwide sales and service organization is ready to provide the support you need.

In general, a problem can be caused by a hardware failure, a software error, or a user error. Follow these general steps to determine the cause and to resolve the problem:

1. Perform the quick checks listed in the "Check the Basics" paragraph; these checks may eliminate the problem altogether, or may give a clearer idea of its cause.
2. If the problem is a hardware problem, you have several options:
  - a. Repair it yourself; see the "Service Options" paragraph.
  - b. Return the analyzer to Hewlett-Packard for repair; if the analyzer is still under warranty or is covered by an HP maintenance contract, it will be repaired under the terms of the warranty or plan (the warranty is at the front of this manual).

If the analyzer is no longer under warranty or is not covered by an HP maintenance plan, Hewlett-Packard will notify you of the cost of the repair after examining the unit. See "How to Call Hewlett-Packard" and "How to Return Your Analyzer for Service" for more information.

---

### Before You Call Hewlett-Packard

#### Check the Basics

A problem often can be solved by rechecking what was being done when the problem occurred. A few minutes spent in performing some simple checks may save waiting for your instrument to be repaired. Before calling Hewlett-Packard or returning the analyzer for service, please make the following checks:

1. Is the rear-panel voltage selector switch set correctly? Is the line fuse good?
2. Does the line socket have power?
3. Is the analyzer plugged in to the proper ac power source?
4. Is the analyzer turned on? Check that the green light above **LINE** is on, indicating that the power supply is on.
5. If other equipment, cables, and connectors are being used with the HP 8591A or HP 8593A, are they connected properly and operating correctly?

6. Review the procedure for the test being performed when the problem appeared. Are all the settings correct?
7. If the display is dark or dim, turn the intensity knob clockwise.
8. If the display focus is poor, reduce the brightness with the intensity knob, or adjust the focus as described in Chapter 7.
9. If the display position is offset, press **CAL**, MORE 1 of 3, CRT VERT POSITION and use the knob or step keys to adjust the vertical position. Press **CAL**, MORE 1 of 3, CRT HORZ POSITION to adjust the horizontal position. Press **CAL**, CAL STORE to save the new vertical and horizontal display position.
10. If you wish to reset the analyzer configuration to the state it was in when it was originally shipped from the factory, use DEFAULT CONFIG. To access DEFAULT CONFIG, press **CONFIG**, MORE 1 of 2, DEFAULT CONFIG, DEFAULT CONFIG (DEFAULT CONFIG requires a double key press). See "DEFAULT CONFIG" in Chapter 7 for more information.
11. Is the test being performed, and the results that are expected, within the specifications and capabilities of the spectrum analyzer? See Chapter 1, Table 1-1 (for the HP 8591A), or Table 1-3 (for the HP 8593A), for analyzer specifications.
12. Are the analyzer's measurements obviously inaccurate? If so, the analyzer's correction factors may have been removed from the measurement results. If this occurs, perform the frequency and amplitude self-calibration routines given in "Turning the Analyzer On for the First Time" in Chapter 2. After running these routines, press CAL STORE, then perform the confidence test. Perform the confidence test by pressing **CAL**, MORE 1 of 3, CONF TEST. The analyzer performs a self-test by cycling through its major functions. The confidence test is performed within 1 to 2 minutes. If the unit does not function properly, messages appear on the screen. See Appendix A for explanations of error messages. If error messages appear, record the messages and refer to the analyzer's service manual or contact the nearest Hewlett-Packard Sales and Service Office listed in Table 8-1.
13. For an HP 8593A with low signal amplitudes above 2.75 GHz, connect a low-loss cable (such as HP part number 8120-5148) from 100 MHz COMB OUT to the analyzer input. Press **CAL**, CAL YTF. The YTF self-calibration routine completes in approximately 4 minutes. Press **CAL**, CAL STORE.
14. If the error message "FREQ UNCAL" stays on screen, run the CAL FREQ self-calibration routine and press CAL STORE.
15. Is the analyzer displaying an error message? If so, refer to Appendix A.
16. If the calibration routines cannot be performed or the calibration data is corrupt, use CAL FETCH to retrieve the correction data that has previously been saved. If the fetched correction data is corrupt, the procedure in step 18 can be used to set the correction data back to predetermined values.
17. If the display is garbled or filled with snow, first try adjusting the horizontal position by pressing **CAL**, the bottom softkey, and the fifth softkey from the top. Turn the knob counterclockwise. The vertical position will not cause this symptom.

18. If the display is still garbled, use **DEFAULT CAL DATA** per the following procedure to reinitialize the memory area for correction factors, instrument configuration, and miscellaneous constants. This procedure will not erase factory-installed calibration factors.
  - a. Press **FREQUENCY**, **-37 Hz**, **CAL**, the bottom softkey, the bottom softkey again, the third softkey from the top. A readable display should appear.
  - b. Perform the **CAL FREQ** and **CAL AMPTD** routines, or the **CAL FREQ & AMPTD** routine. Be sure **CAL OUT** is connected to the analyzer input.

---

**Note**

If the **CAL OUT** signal cannot be found, press **FREQUENCY**, **-37 Hz** before performing the **CAL FREQ** or **CAL FREQ & AMPTD**.

---

- c. For the HP 8593A, connect a low-loss cable, such as HP part number 8120-5148, from 100 MHz COMB OUT to the analyzer input. Press **CAL**, **CAL YTF**. The YTF self-calibration routine completes in approximately 4 minutes.
- d. Set the display position using **CAL**, **MORE 1 of 3**, **CRT VERT POSITION** and **CAL MORE 1 of 3**, **CRT HORZ POSITION**.
- e. Press **CAL**, **CAL STORE**.

---

**Note**

Some user configurations may need to be reset.

---

**DEFAULT CAL DATA** can only be accessed by entering a center frequency of **-37 Hz**. The center frequency **-37 Hz** acts as a pass code for **DEFAULT CAL DATA**.

19. If a program in user memory is suspected of causing problems, use **CONFIG**, **MORE 1 of 2**, **DISPOSE USER MEM**, **DISPOSE USER MEM** (**DISPOSE USER MEM** requires a double key press). **DISPOSE USER MEM** erases all user programs, variables, personalities (DLPs), and user-defined traces in analyzer memory.
20. If the necessary test equipment is available, perform the Performance Verification tests given in Chapter 3 (for the HP 8591A), or Chapter 4 (for the HP 8593A). Record all results on an Performance Verification Test Record form provided at the end of Chapter 3 (for the HP 8591A) or Chapter 4 (for the HP 8593A).

## Read the Warranty

The warranty for your analyzer is at the front of this manual. Please read it and become familiar with its terms.

If your analyzer is covered by a separate maintenance agreement, please be familiar with its terms.

## **Service Options**

Hewlett-Packard offers several optional maintenance plans to service your analyzer after the warranty has expired. Call your Hewlett-Packard Sales and Service office for full details.

If you want to service the analyzer yourself after the warranty expires, you can purchase the service documentation that provides all necessary test and maintenance information.

You can order the service documentation, HP 8591A Option 915 or HP 8593A Option 915, through your Hewlett-Packard Sales and Service office. The package is described under "Service Documentation for the HP 8591A (Option 915)" or "Service Documentation for the HP 8593A (Option 915)" in Chapter 1 of this manual.

## **How to Call Hewlett-Packard**

Hewlett-Packard has Sales and Service offices around the world to provide you with complete support for your analyzer. To obtain servicing information or to order replacement parts, contact the nearest Hewlett-Packard Sales and Service Office listed in Table 8-1. In any correspondence or telephone conversations, refer to the instrument by its model number and full serial number.

**Table 8-1. Hewlett-Packard Sales and Service Offices**

<p><b>IN THE UNITED STATES</b>  <b>California</b>                      Hewlett-Packard Co.                      1421 South Manhattan Ave.                      P.O. Box 4230                      Fullerton, CA 92631                      (714) 999-6700</p>	<p><b>IN AUSTRALIA</b>                      Hewlett-Packard Australia Ltd.                      31-41 Joseph Street                      Blackburn, Victoria 3130                      895-2895</p>	<p><b>IN JAPAN</b>                      Yokogawa-Hewlett-Packard Ltd.                      29-21 Takaido-Higashi, 3 Chome                      Suginami-ku Tokyo 168                      (03) 331-6111</p>
<p>Hewlett-Packard Co.                      301 E. Evelyn                      Mountain View, CA 94039                      (415) 694-2000</p>	<p><b>IN CANADA</b>                      Hewlett-Packard (Canada) Ltd.                      17500 South Service Road                      Trans-Canada Highway                      Kirkland, Quebec H9J 2X8                      (514) 697-4232</p>	<p><b>IN PEOPLE'S REPUBLIC OF CHINA</b>                      China Hewlett-Packard, Ltd.                      P.O. Box 9610, Beijing                      4th Floor, 2nd Watch Factory                      Main Bldg.                      Shuang Yu Shu, Bei San Huan Rd.                      Beijing, PRC                      256-6888</p>
<p><b>Colorado</b>                      Hewlett-Packard Co.                      24 Inverness Place, East                      Englewood, CO 80112                      (303) 649-5000</p>	<p><b>IN FRANCE</b>                      Hewlett-Packard France                      F-91947 Les Ulis Cedex                      Orsay                      (6) 907-78-25</p>	
<p><b>Georgia</b>                      Hewlett-Packard Co.                      2000 South Park Place                      P.O. Box 105005                      Atlanta, GA 30339                      (404) 955-1500</p>	<p><b>IN GERMAN FEDERAL REPUBLIC</b>                      Hewlett-Packard GmbH                      Vertriebszentrale Frankfurt                      Berner Strasse 117                      Postfach 560 140                      D-6000 Frankfurt 56                      (0611) 50-04-1</p>	<p><b>IN SINGAPORE</b>                      Hewlett-Packard Singapore                      Pte. Ltd.                      1150 Depot Road                      Singapore 0410                      273 7388                      Telex HPSGSO RS34209                      Fax (65) 2788990</p>
<p><b>Illinois</b>                      Hewlett-Packard Co.                      5201 Tollview Drive                      Rolling Meadows, IL 60008                      (312) 255-9800</p>	<p><b>IN GREAT BRITAIN</b>                      Hewlett-Packard Ltd.                      King Street Lane                      Winnersh, Wokingham                      Berkshire RG11 5AR                      0734 784774</p>	<p><b>IN TAIWAN</b>                      Hewlett-Packard Taiwan                      8th Floor, Hewlett-Packard                      Building                      337 Fu Hsing North Road                      Taipei                      (02) 712-0404</p>
<p><b>New Jersey</b>                      Hewlett-Packard Co.                      120 W. Century Road                      Paramus, NJ 07653                      (201) 265-5000</p>	<p><b>IN OTHER EUROPEAN COUNTRIES</b>                      Hewlett-Packard (Schweiz) AG                      Allmend 2                      CH-8967 Widen (Zurich)                      (0041) 57 31 21 11</p>	<p><b>IN ALL OTHER LOCATIONS</b>                      Hewlett-Packard Inter-Americas                      3495 Deer Creek Rd.                      Palo Alto, California 94304</p>
<p><b>Texas</b>                      Hewlett-Packard Co.                      930 E. Campbell Rd.                      Richardson, TX 75081                      (214) 231-6101</p>		

---

## How to Return Your Analyzer for Service

### Service Tag

If you are returning the analyzer to Hewlett-Packard for servicing, fill in and attach a blue service tag. Several service tags are supplied at the rear of this manual. Please be as specific as possible about the nature of the problem. If you have recorded any error messages that appeared on the screen, or have completed a Performance Test Record, or have any other specific data on the performance of the analyzer, please send a copy of this information with the unit.

### Original Packaging

Before shipping, pack the unit in the original factory packaging materials if they are available. If the original materials were not retained, identical packaging materials are available through any Hewlett-Packard office. Descriptions of the packaging materials are listed in Table 2-1.

### Other Packaging

---

#### Caution



Analyzer damage can result from using packaging materials other than those specified. Never use styrene pellets in any shape as packaging materials. They do not adequately cushion the equipment or prevent it from shifting in the carton. They cause equipment damage by generating static electricity and by lodging in the analyzer fan.

---

You can repackage the instrument with commercially available materials, as follows:

1. Attach a completed service tag to the instrument.
2. If you have a front-panel cover, install it on the instrument; if not, protect the control panel with cardboard.
3. Wrap the instrument in antistatic plastic to reduce the possibility of damage caused by electrostatic discharge.
4. Use a strong shipping container. A double-walled, corrugated cardboard carton with 159 kg (350 lb) bursting strength is adequate. The carton must be both large enough and strong enough to accommodate the analyzer. Allow at least 3 to 4 inches on all sides of the analyzer for packing material.
5. Surround the equipment with three to four inches of packing material and prevent the equipment from moving in the carton. If packing foam is not available, the best alternative is S.D.-240 Air Cap\_T\_M from Sealed Air Corporation (Commerce, California, 90001). Air Cap looks like a plastic sheet filled with 1-1/4 inch air bubbles. Use the pink-colored Air Cap to reduce static electricity. Wrapping the equipment several times in this material should both protect the equipment and prevent it from moving in the carton.
6. Seal the shipping container securely with strong nylon adhesive tape.
7. Mark the shipping container "FRAGILE, HANDLE WITH CARE" to assure careful handling.
8. Retain copies of all shipping papers.



## Analyzer Error Messages

---

The analyzer can generate various messages that appear on its screen during operation to indicate a problem.

There are three types of messages: hardware error messages (H), user-created error messages (U), and informational messages (M).

- Hardware error messages indicate the analyzer hardware is probably broken. Refer to Chapter 8 for more information.
- User-created error messages appear when the analyzer is used incorrectly. They are usually generated during remote operation (entering programming commands using a controller or the external keyboard). See the *HP 8590 Series Spectrum Analyzer Programming Manual* for more information.
- Informational messages indicate the analyzer's progress within a specific procedure.

The messages are listed in alphabetical order on the following pages; each message is defined, and its type is indicated by an (H), (U), or (M).

### ADC-GND FAIL

Indicates a failure in the processor. (H)

### ADC-TIME FAIL

Indicates a failure in the processor. (H)

### ADC-2V FAIL

Indicates a failure in the processor. (H)

### CAL: \_ \_ \_

During the self-calibration routine, messages may appear on the display indicating the routine is progressing: SWEEP, FREQ, SPAN, AMPTD, FM GAIN + OFFSET, 3dB BW, ATTEN, LOG AMP, PEAKING, YTF. FREQ UNCAL appears briefly during CAL FREQ. This is normal and does not indicate a problem. (M)

### CAL: DATA NOT STORED

### CAL AMP NEEDED

The correction factors are corrupt and cannot be stored. Perform the CAL FREQ & AMPTD routine. (U) (H)

### CAL: cannot execute CALAMP

enter: 0 dB PREAMP GAIN

The preamp gain should be set to 0 dB before the CAL AMPTD routine is performed. The preamp gain is set by using EXT PREAMP. (U) (H)

### CAL: FM SPAN SENS FAIL

The analyzer could not set up span sensitivity of the FM coil. (H)



**CAL: GAIN FAIL**

Indicates the signal amplitude is too low during the **CAL AMPTD** routine. (H)

**CAL: LOST COMB SIGNAL**

Indicates the amplitude of the comb generator signal is insufficient to complete the **CAL YTF**. Be sure to use a low-loss cable (SMA-to-type N cable) to connect the comb generator output to the analyzer input before using **CAL YTF**. (U) (H)

**CAL: NO YTF IN 8590/1**

The **CAL YTF** programming command is available for the HP 8592B and the HP 8593A only. (U)

**CAL: NO YTO AVAILABLE**

The **CAL DLY** programming command is no longer necessary. (U)

**CAL: PASSCODE NEEDED**

Indicates that the function cannot be accessed without the pass code. (M)

**CAL: RES BW AMPL FAIL**

The relative insertion loss of the resolution bandwidth is incorrect. (H)

**CAL SIGNAL NOT FOUND**

Indicates the **CAL OUT** signal cannot be found. Check that the **CAL OUT** is connected to the analyzer input connector using an appropriate cable. If the **CAL OUT** signal is connected to the analyzer input but cannot be found, press **FREQUENCY**, **-37 Hz** before performing the **CAL FREQ** or **CAL FREQ & AMPTD**. (U) (H)

**CAL: SPAN SENS FAIL**

The self-calibration span sensitivity routine failed. (H)

**CAL: USING DEFAULT DATA**

Indicates the calibration data is corrupt and default correction factors are being used. Interruption of the self-calibration routines or an error can cause this problem. (M)

**COMB SIGNAL NOT FOUND**

The comb signal cannot be found. Check that 100 MHz **COMB OUT** is connected to the analyzer input. The comb generator is available with the HP 8592B or HP 8593A only. (U) (H)

**COMMAND ERROR: \_ \_ \_**

The specified programming command is not recognized by the analyzer. (U)

**CONFLICT TABLE OVERFLOW**

Indicates that too many two-letter compatible commands have been used. See Table 4-3 in the *HP 8590 Series Spectrum Analyzer Programming Manual* for information about substituting alternate commands for two-letter compatible commands. (U)

**CONF TEST FAIL**

Indicates that the confidence test failed. (H)

**DECR SPAN**

Indicates the resolution bandwidth to span ratio is too small to use the marker count function. Check the span and bandwidth settings. (U)

**FAIL: \_ \_ \_**

An error was discovered during the power-up check. The 4-digit by 10-digit code indicates the type of error. Error codes are described in the analyzer Service Manual. (H).

**FREQ UNCAL**

Indicates a YTO-tuning failure. This may occur when using default correction factors. Performing the **CAL FREQ** routine may eliminate the failure. The **FREQ UNCAL** message appears briefly during the **CAL FREQ** routine or when changing the frequency value with the knob (it does not indicate a problem). (U) (H)

**INVALID ACTDEF: \_ \_ \_**

The specified ACTDEF name is not valid. See the ACTDEF programming command. (U)

**INVALID AMPCOR: FREQ**

For the AMPCOR command, the frequency data must be in increasing order. See the AMPCOR programming command. (U)

**INVALID AUNITS: \_ \_ \_**

The amplitude units are not valid. See the AUNITS programming command. (U)

**INVALID BLOCK FORMAT: IF STATEMENT**

An invalid block format appeared within the IF statement. (U)

**INVALID CARD: DIRECTORY**

Indicates the memory card has not been formatted. (U)

**INVALID CARD: NO CARD**

Indicates a memory card has not been inserted. (U)

**INVALID CARD**

Indicates a card reader is not installed, the memory card is write-protected, the memory card is a read-only card, or a memory card has not been inserted. (U)

**INVALID CARD: TYPE**

Indicates a card reader is not installed, the memory card is write-protected, the memory card is a read-only card, or a memory card has not been inserted. (U)

**INVALID CHECKSUM: USTATE**

The user-defined state does not follow the expected format. (U)

**INVALID COMPARE OPERATOR**

An IF/THEN or REPEAT/UNTIL routine is improperly constructed. Specifically, the IF or UNTIL operands are incorrect. (U)

**INVALID DETECTOR: \_ \_ \_**

The specified detector is not valid. See the DET programming command. (U)

**INVALID ENTER FORMAT**

The enter format is not valid. See the appropriate programming command description to determine the correct format. (U)

**INVALID FILE: NO ROOM** Indicates that there is not enough available space on the memory card to store the data. (U)

**INVALID HP-IB ADDRESS/OPERATION**

An HP-IB operation was aborted due to an incorrect address or invalid operation. Check that there is only one controller (the analyzer) connected to the printer. (U)

**INVALID HP-IB OPERATION REN TRUE**

The HP-IB operation is not allowed. (This is usually caused by print/plot when a controller is on the interface bus.) (U)

**INVALID ITEM:**

Indicates an invalid parameter has been used in a programming command. (U)

**INVALID KEYNAME: \_ \_ \_**

The specified key name is not allowed. (The key name may have conflicted with an analyzer programming command.) Use an underscore as the second character in the key name, or avoid beginning the key name with the following pairs of letters: LB, OA, OL, TA, TB, TR, MA, MF, TS, OT, and DR. (U)

**INVALID OUTPUT FORMAT**

The output format is not valid. See the appropriate programming command description to determine the correct format. (U)

**INVALID REGISTER NUMBER**

The specified trace register number is invalid. (U)

**INVALID REPEAT MEM OVFL**

Memory overflow occurred due to a REPEAT routine. This occurs if the repeat statements are too long. (U)

**INVALID REPEAT NEST LEVEL**

The nesting level in the REPEAT routine is improperly constructed. This can occur if too many REPEAT routines are nested. (U)

**INVALID RS-232 ADDRESS/OPERATION**

An RS-232 operation was aborted due to an incorrect address or invalid operation. (U)

**INVALID SAVEREG**

Data has not been saved in the specified state or trace register, or the data is corrupt. (U)

**INVALID STORE DEST: \_ \_ \_**

The specified destination field is invalid. (U)

**INVALID SYMTAB ENTRY: SYMTAB OVERFLOW**

There is a symbol table overflow. This can occur if there are too many user-defined items (functions, variables, key definitions) or downloadable programs in analyzer memory. Use **DELETE FILE** or **DISPOSE USER MEM** to delete unnecessary items. This can also occur when the processor board has failed. See the analyzer's Service Manual for more information. (U)

**INVALID TRACE: \_ \_ \_**

The specified trace is invalid. (U)

**INVALID TRACE NAME: \_ \_ \_**

The specified trace name is not allowed. Use an underscore as the second character in the trace name, or avoid beginning the trace name with the following pairs of letters: LB, OA, OL, TA, TB, TR, MA, MF, TS, OT, and DR. (U)

**INVALID TRIGGER MODE: \_ \_ \_**

The specified trigger mode is invalid. See the TM programming command. (U)

**INVALID VALUE PARAMETER: \_ \_ \_**

The specified value parameter is invalid. (U)

**INVALID VARDEF: \_ \_ \_**

The specified variable name is not allowed. Use an underscore as the second character in the variable label, or avoid beginning the variable label with the following pairs of letters: LB, OA, OL, TA, TB, TR, MA, MF, TS, OT, and DR. (U)

**INVALID WINDOW TYPE: \_ \_ \_**

The specified window is invalid. See the TWINDOW programming command. (U)

**MEAS UNCAL**

The measurement is uncalibrated. Check the sweep time, span, and bandwidth settings. (U)

**NO CARD FOUND**

Indicates that the memory card is not inserted. (U)

**OVEN COLD**

Indicates that the analyzer has been powered up for less than 5 minutes. (Option 004 only.) (M)

**PARAMETER ERROR: \_ \_ \_**

The specified parameter is not recognized by the analyzer. See the appropriate programming command description to determine the correct parameters. (U)

**POS-PK FAIL**

Indicates the positive-peak detector has failed. (H)

**RES-BW SHAPE FAIL**

Indicates the 3 dB bandwidth is not within specifications. (H)

**REF UNLOCK**

Indicates that the frequency reference is not locked to the external reference input. Check that the 10 MHz REF OUT is connected to the EXT REF IN, or that an external 10 MHz reference source is connect to the EXT REF IN (when using an external reference). (M)

**RES-BW NOISE FAIL**

Indicates the noise floor level is too high at the indicated bandwidth. (H)

**SAMPLE FAIL**

Indicates the sample detector has failed. (H)

**SOFTKEY OVFL**

Softkey nesting exceeds the maximum number of levels. (U)

**SRQ \_ \_ \_**

The specified service request is active. Service requests are a form of informational message and are explained in Appendix B. (M)

**STEP GAIN ATTEN FAIL**

Indicates the step gain has failed. (H)

**TABLE FULL**

Indicates the upper or lower table of limit lines contains the maximum number of entries allowed. Additional entries to the table are ignored. (U)

**TG SIGNAL NOT FOUND**

Indicates the tracking generator output signal cannot be found. Check that the tracking generator output (RF OUT 50 $\Omega$  or RF OUT 75 $\Omega$ ) is connected to the analyzer input connector using an appropriate cable. (U)

**TG UNLVL**

Indicates that the source power is set higher or lower than the analyzer can provide (HP 8591A with Option 010 or 011 only). See "Stimulus-Response Measurements" in Chapter 6 for more information.

**UNDEF KEY**

A softkey referred to is not recognized by the analyzer. (U)

**VID-BW FAIL**

Indicates the video bandwidth(s) have failed. (H)

## SRQ

---

### Service Requests

This appendix describes the analyzer service request (SRQ) capability. A service request is an analyzer output that tells the operator or computer that a specific event has taken place in the analyzer.

When writing programs, service requests can be used to interrupt the computer program sequence, causing the program to branch to a subroutine. For example, by using service requests, the computer can perform other operations while the analyzer is sweeping. When the sweep is completed, the computer can service the analyzer by changing the analyzer state or reading data from the display memory.

---

**Note**  Service requests do not work with computers that have an RS-232 interface. Not all service requests are available with some HP-IB computers. Refer to the manuals supplied by your computer's manufacturer.

---

When making a service request, the analyzer places the I/O interface SRQ line true and the analyzer CRT display reads out SRQ with a number. Setting the SRQ line true announces to the computer that the analyzer requires attention. The computer can then command the analyzer to send its "status byte." The status byte indicates the type of service request.

---

**Note**  If the CRT display annotation has been blanked, the service request notation will not appear.

A serial polling technique must be used by the computer to test for service requests. The analyzer does not respond to parallel polling.

---

### Status Byte Definition

The status byte sent by the analyzer determines the nature of the service request. The meaning of each bit of the status byte is explained in Table B-1.

**Table B-1. Status Byte Definition**

Bit	Message	CRT Display Message
0 (LSB)	Unused	-
1	Unit Key Pressed	SRQ 102
2	End of sweep	SRQ 104
3	Hardware broken	SRQ 110
4	Command complete	SRQ 120
5	Illegal analyzer command	SRQ 140
6	Universal HP-IB service request HP-IB RQS bit	-
7	Unused	-

The CRT display message is an octal number based on the binary value of the status byte. This octal number always begins with a "1" since this is translated from bit 6, the universal service request bit. The status byte for an illegal analyzer command (SRQ 140) is as follows:

bit number	7	6	5	4	3	2	1	0
status byte	0	1	1	0	0	0	0	0

The CRT displays the octal equivalent of the status byte binary number: SRQ 140

The octal equivalent is based on the whole binary number:

01100000 (binary) = 140 (octal)

One simple way to determine the octal equivalent of the binary number is to partition the binary number three bits at a time from the least significant bit, and treat each part as a single binary number:

binary	0 1	1 0 0	0 0 0
octal	1	4	0

The decimal equivalent of the octal number is determined as follows:

140 (octal) =  $1 \times (8) + 4 \times (8) + 0 \times (8) = 96$  (decimal)

More than one service request can be sent at the same time. For example, if an illegal analyzer command (SRQ 140) and the end of a sweep (SRQ 104) occurred at the same time, SRQ 144 appears on the CRT display, because both bit 5 and bit 2 are set as shown below:

bit number	7	6	5	4	3	2	1	0
status byte	0	1	1	0	0	1	0	0
octal value	1		4			4		

= SRQ 144

### Service Request Activating Commands

With the exceptions of SRQ 140 and SRQ 110, service requests can only be activated from a computer. (SRQ 140 and SRQ 110 are always activated.) Your *HP 8590 Series Programming Manual* describes service request activating commands in Chapter 4 under RQS and SRQ.

# Index

---

%

%AM, 7-11

## Numbers

0-2.9 Gz BAND 0, 7-11, 7-14

2v REF DETECTOR, 7-9

2 75-6.4 BAND 1, 7-11, 7-14

3 dB POINTS, 7-11

3rd ORD MEAS, 7-11

6 dB POINTS, 7-11

6.0-12.8 BAND 2, 7-11, 7-14

9 kHz EMI BW, 7-11

9 kHz resolution bandwidth. *See* 9 kHz EMI BW

10 MHz REF OUTPUT, 5-4, 7-55

+10V REF DETECTOR, 7-9

-10V REF DETECTOR, 7-10

12.4-19. BAND 3, 7-11, 7-14

19 1-22 BAND 4, 7-11, 7-14

50Ω/75Ω minimum loss pad, 1-4

50Ω transmission/reflection test set, 1-4

75Ω input impedance (Option 001), 1-2

75Ω matching transformer, 1-4

99% PWR BW, 7-11

100 MHz COMB OUT, 5-3, 7-54

120 kHz EMI BW, 7-11

120 kHz resolution bandwidth. *See* 120 kHz EMI BW

## A

A <—> B, 7-11

A - B -> A ON OFF, 7-11

ABCDEF, 7-12

A -> C, 7-12

### accessories

50Ω/75Ω minimum loss pad, 1-4

50Ω transmission/reflection test set, 1-4

75Ω matching transformer, 1-4

AC power source, 1-4

AC probe, 1-5

broadband preamplifiers, 1-5

CATV measurements card, 1-5

close-field probes, 1-5

digital radio measurements card for the HP 8593A, 1-5

EMI diagnostics measurements card for the HP 8591A, 1-5

external keyboard, 1-6

external keyboard cable, 1-6

HP-IB cable, 1-6

memory card, 1-6

monitor, 1-6

plotter, 1-6

printer, 1-6

rack slide kit, 1-6

RF limiters, 1-7

RS-232 cable, 1-7

transit case, 1-7

accessories shipped with the analyzer, 2-3

AC power source, 1-4

AC probe, 1-5

active function, 5-6

active function block, 5-1

ALC MTR INT XTAL, 7-12

ALC TEST, 7-10

ALL DLP -> CARD, 5-24, 7-12

AM/FM speaker and TV sync trigger circuitry (Option 102), 1-3

AMPCOR, 5-38

AMPLITUDE, 5-2, 5-7, 7-12

amplitude correction factors, 5-37-38. *See also* AMPLTUD COR FACT

cataloging, 7-17

saving, 7-12

amplitude correction factors, cataloging *See* CATALOG AMP CORR

amplitude functions *See* AMPLITUDE

AMPLTUD COR FACT, 7-12

AMPTD UNITS, 7-13

dBm, 7-25

dBmV, 7-25

dBuV, 7-25

Volts, 7-51

Watts, 7-51

ANALYZER ADDRESS, 7-13

analyzer battery, 2-12

analyzer error messages, A-1

annotation, 5-10. *See also* ANNOTATN ON OFF ANNOTATN ON OFF, 7-13

ATTEN AUTO MAN, 7-13

attenuation. *See* ATTEN AUTO MAN



AUTO ALL, 7-13  
AUTO COUPLE, 7-13  
AUX A, 7-9  
AUX B, 7-9  
AUX CONN CONTROL, 7-14  
AUX CTRL, 7-14  
AUX IF OUTPUT, 5-5, 7-56  
auxiliary interface. *See* AUX CONN CONTROL  
AUX INTERFACE, 5-5, 7-55  
AUX VIDEO OUTPUT, 5-5, 7-56

## B

B & W PRINTER, 7-14  
BAND LOCK, 6-32, 7-14  
battery. *See* analyzer battery, memory card  
BAUD RATE, 7-14  
B -> C, 7-14  
B - DL -> B, 7-14  
B <-> C, 7-14  
binary, B-2  
BINARY SPAN, 7-9  
BLANK A, 7-15  
BLANK B, 7-15  
BLANK C, 7-15  
BLANK CARD, 5-20, 7-15  
BND LOCK ON OFF, 6-32, 7-15  
broadband preamplifiers, 1-5  
BW, 7-15

## C

CAL, 5-12, 7-15  
CAL AMPTD, 5-12, 7-15  
CAL FETCH, 5-12, 7-16  
CAL FREQ, 5-12, 7-16  
CAL FREQ & AMPTD, 5-12, 7-16  
calibration  
  self-calibration routines, 5-12  
CAL MXR, 7-16  
CAL OUT, 5-3, 7-54  
cal output, 5-3  
CAL STORE, 5-12, 7-16  
CAL TIMEBASE, 7-16  
CAL TRK GEN, 2-8, 5-13, 7-16  
CAL YTF, 2-9, 5-14, 7-16  
CARD CONFIG, 7-16  
CARD -> DLP, 7-16  
CARD -> STATE, 7-16  
CARD -> TRACE, 7-17  
CATALOG ALL, 7-17  
CATALOG AMP CORR, 7-17  
CATALOG CARD, 5-21, 7-17  
CATALOG DLP, 7-19  
CATALOG INTRNL, 7-19  
CATALOG LMT LINE, 7-20  
CATALOG PREFIX, 7-20

CATALOG REGISTER, 7-20  
CATALOG STATES, 7-20  
CATALOG TRACES, 7-20  
CATALOG VARIABLES, 7-20  
CATV measurements card, 1-5  
CENTER FREQ, 7-21  
center frequency, 7-21  
center frequency step size, 7-21. *See also* CF  
  STEP AUTO MAN  
CF STEP AUTO MAN, 7-21  
CHANGE PREFIX, 7-21  
CHANGE TITLE, 7-21  
changing the analyzer's power-on state, 5-39  
characteristics for the HP 8591A, 1-14-22  
characteristics for the HP 8593A, 1-26-31  
checking the fuse, 2-4  
CLEAR, 7-22  
clearing the prefix. *See* CLEAR  
clearing the screen title. *See* CLEAR  
CLEAR WRITE A, 7-22  
CLEAR WRITE B, 7-22  
CLEAR WRITE C, 7-22  
close-field probes, 1-5  
CNTL A 0 1, 7-22  
CNTL B 0 1, 7-22  
CNTL C 0 1, 7-22  
CNTL D 0 1, 7-22  
CNT RES AUTO MAN, 6-6, 7-22  
COARSE TUNE DAC, 7-9  
COMB GEN ON OFF, 6-32, 7-23  
command complete, B-1  
common measurements  
  stimulus-response, 6-34-41  
confidence test, 7-23, 8-2  
CONFIG, 7-23  
configuration, 7-23  
CONF TEST, 7-23, 8-2  
continuous sweep, 7-47  
control functions, 5-3  
COPY, 5-3, 7-23  
COPY DEV PRNT PLT, 7-24  
correction factors, 5-12  
CORRECT ON OFF, 5-13, 7-25  
CRT HORZ POSITION, 7-25  
CRT VERT POSITION, 7-25

## D

DACS, 7-9  
data controls, 7-52  
data keys, 5-3  
DATEMODE MDY DMY, 7-25  
dBm, 7-25  
dBmV, 7-25  
dBuV, 7-25

DEFAULT CAL DATA, 7-25, 8-3  
 DEFAULT CONFIG, 7-25  
 DELETE FILE, 7-26  
 DELETE SEGMENT, 7-26  
 delta marker, 6-12  
 DELTA MEAS, 6-14, 7-26  
 DEMOD, 6-41, 7-26  
 DEMOD AM FM, 6-41, 7-26  
 DEMOD ON OFF, 6-41, 7-27  
 demodulation, 7-26  
     continuous, 6-42  
     demodulation AM FM, 7-26  
     demodulation on off, 7-27  
     dwell time, 7-28  
     FM gain, 7-30  
     speaker on off, 7-46  
     squelch, 7-46  
 DETECTOR SAMPLE PK, 7-27  
 digital radio measurements card for the HP  
     8593A, 1-5  
 DISPLAY, 7-27  
 DISPLAY CAL DATA, 7-9  
 DISPLAY CNTL I, 7-27  
 display line, 7-28. *See also* DSP LINE ON OFF  
 DISPOSE USER MEM, 7-27  
 distortion products, 6-22  
 DLP, 5-24  
 downloadable programs, 5-24  
 DROOP, 7-10  
 DSP LINE ON OFF, 7-28  
 DWELL TIME, 7-28

**E**

earphone connector, 5-4, 7-55  
 EDIT DONE, 5-30, 5-35, 7-28  
 EDIT FLATNESS, 7-28  
 EDIT LIMIT, 5-28, 5-30, 7-28  
 EDIT LOWER, 5-30, 7-28  
 EDIT MID/DELT, 5-30, 7-28  
 EDIT UP/LOW, 5-30, 7-28  
 EDIT UPPER, 5-28, 5-30, 7-29  
 EDIT UPR LWR, 7-29  
 electrostatic discharge, 1-32  
 EMI diagnostics measurements card for the HP  
     8591A, 1-5  
 end of sweep, B-1  
 entering amplitude correction factors, 5-37  
 entering a prefix, 5-21  
 ESD, 1-32  
     reducing damage caused by ESD, 1-33  
     static-safe accessories, 1-33  
     static-safe work station, 1-32  
 EXECUTE TITLE, 5-37, 7-29  
 EXIT, 7-29  
 EXIT CATALOG, 7-29

EXIT SHOW, 7-29  
 EXTERNAL, 7-29  
 external keyboard, 1-6  
 external keyboard cable, 1-6  
 external keyboard connector, 5-5, 7-56-57  
 external keyboard operation, 5-39  
 external trigger. *See* EXTERNAL  
 EXT KEYBOARD, 5-5  
 EXT PREAMP, 7-29  
 EXT REF IN, 5-4, 7-55  
 EXT TRIG INPUT, 5-5, 7-56

**F**

fast Fourier transform. *See* FFT MEAS  
 fast Fourier transform function, 6-28  
 fast time domain sweeps (Option 101), 1-3  
 FFT MEAS, 6-28, 7-29  
 FINE TUNE DAC, 7-9  
 fix-tuned receiver, 6-26  
 FLAT, 5-33, 7-30  
 FLATNESS DATA, 7-30  
 FM COIL DRIVE, 7-9  
 FM GAIN, 6-43, 7-10, 7-30  
 FM OFFSET, 7-10  
 FM SPAN, 7-9  
 focus  
     fine-focus control, 7-53  
 FORMAT CARD, 5-20, 7-30  
 FREE RUN, 7-30  
 FREQ DIAG, 7-10  
 FREQ OFFSET, 7-30  
 FREQUENCY, 5-2, 5-7, 7-30  
 frequency and amplitude self-calibration routine,  
     2-8  
 frequency functions. *See* FREQUENCY  
 frequency offset, 7-30  
 frequency range to 26.5 GHz extension (Option  
     026), 1-3  
 front-panel overview, 5-1-3  
 FRQ DISC NORM OFF, 7-10  
 FULL SPAN, 7-30  
 fuse, 2-4

**G**

GHIJKL, 7-31  
 GND REF DETECTOR, 7-9  
 GRAT ON OFF, 7-31

**H**

hardware broken, B-1  
 hardware error messages, A-1  
 hardware problems, 8-1  
 harmonic lock, 6-32, 7-15  
 HI SWEEP IN/OUT, 5-5, 7-56

HOLD, 7-52  
how to call Hewlett-Packard, 8-4  
how to return your analyzer for service, 8-6  
HP-IB cable, 1-6  
HP-IB interface connector, 5-5  
HP-IB (Option 021), 1-2

## I

illegal analyzer command, B-1  
impact cover assembly (Option 040), 1-3  
informational messages, A-1  
initial inspection, 2-1  
INPUT 50 $\Omega$ , 5-3, 7-54  
INPUT 75 $\Omega$ , 5-3  
input impedance, 7-31. *See also* INPUT Z 50 75  
INPUT Z 50 75, 7-31  
instrument preset, 7-38  
instrument state, 5-2  
intensity control, 5-3, 7-53  
interface connectors, 5-5, 7-56  
INTRNL CRD, 7-31  
INTRNL -> STATE, 7-31  
INTRNL -> TRACE, 7-31

## K

knob, 5-3, 7-52

## L

LEVELING INPUT, 5-5, 7-57  
LIMI FAIL, 5-27  
LIMI PASS, 5-27  
limit-line functions, 5-30-35  
limit-lines  
  creating, 5-28-30  
limit lines, 5-27  
  amplitude coordinate, 5-33  
  cataloging, 7-20  
  delete segment, 7-26  
  edit done, 7-28  
  editing, 5-29  
  edit limit, 7-28  
  edit lower, 7-28  
  edit mid/delta amplitude, 7-28  
  edit upper, 7-29  
  edit upper and lower amplitude, 7-28  
  edit upper lower amplitude, 7-29  
  fixed, 5-30  
  fixed and relative, 7-31  
  flat, 7-30  
  frequency coordinate, 5-32  
  new limit, 7-35  
  point, 7-37  
  purge limits, 7-41  
  recall limit, 7-41

  relative, 5-30  
  save limit, 7-43  
  segment number, 5-31  
SEGMENT TYPE, 5-33  
select amplitude, 7-44  
select delta amplitude, 7-44  
select frequency, 7-44  
select lower amplitude, 7-44  
select middle amplitude, 7-44  
select segment, 7-44  
select type, 7-44  
select upper amplitude, 7-44  
slope, 7-45  
table format, 5-30  
table type, 5-30  
testing, 5-35  
  using RECALL LIMIT, 5-35  
  using SAVE LIMIT, 5-35  
LIMIT LINES, 5-30, 7-31  
LIMITS FIX REL, 5-28, 5-30, 7-31  
LIMITS ON OFF, 5-30, 5-35, 7-32  
LINE, 7-32  
linear scale, 7-43. *See also* SCALE LOG LIN  
LINE front-panel key, 5-3, 7-53  
line voltage selector switch, 2-4  
LOAD FILE, 7-32  
(LOCAL), 7-23, 7-32  
local operation, 7-23, 7-32  
log scale, 7-43. *See also* SCALE LOG LIN  
LO OUTPUT, 5-4, 7-55  
lower limit line, 5-31  
low-level signals, 6-16  
  reducing attenuation, 6-16  
  reducing resolution bandwidth, 6-18  
  reducing video bandwidth, 6-19  
  video averaging, 6-20

## M

MAIN COIL DR, 7-9  
MAIN SPAN, 7-9  
making a measurement, 5-6-8  
MAN TRK ADJUST, 6-38, 7-33  
manuals  
  extra installation, verification, and operation  
  manuals (Option 910), 1-4  
manual tracking adjustment, 7-33  
marker, 7-34  
MARKER, 5-8  
MARKER AMPTD, 7-33  
MARKER -> CF, 7-33  
MARKER -> CF STEP, 7-33  
marker counter, 6-6, 7-34  
marker count resolution. *See* CNT RES AUTO  
  MAN  
marker delta, 6-12

MARKER DELTA, 6-13, 7-33  
 marker functions, 5-3  
 MARKER NORMAL, 5-8, 7-33  
 MARKER -> REF LVL, 7-34  
 MARKERS OFF, 7-34  
 MAX HOLD A, 6-10, 7-34  
 MAX HOLD B, 7-34  
 maximum hold, 6-9  
 maximum mixer level, 7-34  
 MAX MXR LEVEL, 7-34  
 MEAS/USER, 7-34  
 MEM LOCKED, 7-43  
 memory card  
   blank card, 5-20  
   card configuration, 7-16  
   cataloging, 5-21  
   changing the memory card battery, 2-10  
   formatting, 5-20, 7-30  
   inserting a memory card, 2-9  
   memory card battery, 2-10  
   preparation for use, 5-20  
 memory card reader, 5-3  
 menu and softkey overview, 5-6  
 message block, 5-1  
 mid/delta limit line table format, 5-31  
 MIN HOLD C, 6-11, 7-34  
 MINIMUM -> MARKER, 7-34  
 MIXER BIAS, 7-10  
 MKNOISE ON OFF, 7-34  
 MKPAUSE ON OFF, 7-34  
 MKR, 7-34  
 MKR ->, 7-34  
 MKR CNT ON OFF, 6-6, 7-35  
 MKR  $\Delta$  -> SPAN, 7-35  
 MNOPQR, 7-35  
 MODE, 5-2, 7-35  
 monitor, 1-6  
 MONITOR OUTPUT, 5-4, 7-55

## N

NEW LIMIT, 5-28, 5-30, 7-35  
 NEXT PEAK, 7-35  
 NEXT PK LEFT, 7-35  
 NEXT PK RIGHT, 7-35  
 normalization, 6-39  
 NORMLIZE ON OFF, 6-39, 7-35  
 NORMLIZE POSITION, 7-36  
 NO USER MENU, 7-36  
 NTSC, 7-36  
 number/units keypad, 7-52

## O

octal to binary, B-2  
 options  
   75 $\Omega$  input impedance (Option 001), 1-2  
   AM/FM speaker and TV sync trigger circuitry (Option 102), 1-3  
   extra installation, verification, and operation manuals (Option 910), 1-4  
   fast time domain sweeps (Option 101), 1-3  
   frequency range to 26.5 GHz extension (Option 026), 1-3  
   HP-IB (Option 021), 1-2  
   impact cover assembly (Option 040), 1-3  
   precision frequency reference (Option 004), 1-2  
   rack mount flange kit (Option 908), 1-3  
   rack mount flange kit with handles (Option 909), 1-3  
   RS-232 (Option 023), 1-3  
   service documentation (Option 915), 1-4  
   soft carrying case (Option 042), 1-3  
   tracking generator (Option 010 or 011), 1-2  
 output power, 7-46

## P

packaging, 2-1-2, 8-6  
 PAINTJET PRINTER, 7-36  
 PAL, 7-36  
 PAL-M, 7-36  
 parallel polling, B-1  
 peak detection. *See* DETECTOR SAMPL PK  
 PEAK EXCURSN, 7-36  
 PEAK MENU, 7-37  
 peak response routine, 7-49  
 PEAK SEARCH, 5-8, 7-37  
 PK-PK MEAS, 7-37  
 PLOT CONFIG, 7-37  
 plotter, 1-6  
 PLOTTER ADDRESS, 7-37  
 plotting, 7-23  
 PLT - - LOC - -, 7-37  
 PLTS/PG 1 2 4, 7-37  
 POINT, 5-33, 7-37  
 power cable, 2-5  
 power input, 5-4, 7-55  
 POWERON, 5-39  
 power requirements, 2-3  
 preamplifier gain. *See* EXT PREAMP  
 precision frequency reference (Option 004), 1-2  
 preparing the analyzer for use, 2-3  
 PRESEL DAC, 7-10  
 PRESEL DEFAULT, 6-8, 7-37  
 preselector default, 7-37  
 preselector peak, 6-8, 7-37  
 preselector peaking. *See* PRESEL PEAK

PRESEL PEAK, 6-8, 7-37  
PRESET, 5-2, 7-38  
PRESET SPECTRUM, 7-39  
PRINT CONFIG, 7-40  
printer, 1-6  
PRINTER ADDRESS, 7-40  
PRINTER SETUP, 7-40  
printing, 7-23  
    PaintJet printer, 7-36  
PROBE POWER, 7-54  
PROBE PWR, 5-3  
PRT MENU ON OFF, 7-40  
PURGE LIMITS, 5-30, 7-41  
PWR SWP ON OFF, 7-41

## R

rack mount flange kit (Option 908), 1-3  
rack mount flange kit with handles (Option 909),  
    1-3  
rack slide kit, 1-6  
real-time clock, 7-48  
    set date, 7-45  
    set time, 7-45  
    time/date display, 7-48  
rear-panel battery information label, 2-13  
rear-panel connectors, 7-55  
rear-panel features, 5-4-5  
RECALL, 7-41  
recalling amplitude correction factors from ana-  
    lyzer memory, 5-17  
recalling amplitude correction factors from the  
    memory card, 5-24  
recalling a program from the memory card, 5-25  
recalling a state from analyzer memory, 5-15  
recalling a state from the memory card, 5-22  
recalling a trace from analyzer memory, 5-16  
recalling a trace from the memory card, 5-23  
recalling limit lines from analyzer memory, 5-17  
recalling limit-line tables from the memory card,  
    5-24  
RECALL LIMIT, 7-41  
reference connector, 2-7  
reference level, 7-42  
reference level offset, 7-42. *See also* reference level  
REF LVL, 7-42  
REF LVL OFFSET, 7-42  
remote operation, 7-23  
RES BW AUTO MAN, 7-42  
resolution bandwidth  
    resolving signals, 6-2-5  
RF limiters, 1-7  
RF OUT 50 $\Omega$ , 5-3, 7-55  
RF OUT 75 $\Omega$ , 5-3, 7-55  
RPG TITLE, 7-42  
RS-232 cable, 1-7

RS-232 interface connector, 5-5  
RS-232 (Option 023), 1-3

## S

sales and service offices, 8-5  
sample detection. *See* DETECTOR SAMPL PK  
SAVE, 7-42  
SAVE LIMIT, 7-43  
saving a limit-line table into analyzer memory, 5-  
    17  
saving amplitude correction factors into analyzer  
    memory, 5-17  
saving amplitude correction factors on the mem-  
    ory card, 5-23-24  
saving and recalling data from analyzer memory,  
    5-15-18  
saving and recalling data from the memory card,  
    5-19-26  
saving and recalling programs with a memory  
    card, 5-24  
saving a program on the memory card, 5-24-25  
saving a state into analyzer memory, 5-15  
saving a state on the memory card, 5-21  
saving a trace into analyzer memory, 5-16  
saving a trace on the memory card, 5-22  
saving limit-line tables on the memory card, 5-23-  
    24  
SAV LOCK ON OFF, 5-17, 7-43  
SCALE LOG LIN, 7-43  
screen annotation, 5-10-11  
screen graticule. *See* GRAT ON OFF  
screen title. *See* CHANGE TITLE  
    RPG TITLE, 7-42  
SECAM-L, 7-44  
SELECT AMPLITUD, 5-33, 7-44  
SELECT DLT AMPL, 5-33, 7-44  
SELECT FREQ, 5-32, 7-44  
SELECT LWR AMPL, 5-33, 7-44  
SELECT MID AMPL, 5-33, 7-44  
SELECT SEGMENT, 5-31, 7-44  
SELECT TYPE, 7-44  
SELECT UPR AMPL, 5-33, 7-44  
self-calibration routines, 5-12-14, 7-15  
serial numbers, 1-7  
serial polling, B-1  
SERVICE CAL, 7-45  
SERVICE DIAG, 7-9  
service documentation (Option 915), 1-4  
service options, 8-4  
service requests, B-1  
service tag, 8-6  
SET ATTN ERROR, 7-45  
SET DATE, 7-45  
SETPLL OUTDAC, 7-10  
SET TIME, 7-45

setting the amplitude, 5-7  
 setting the center frequency, 5-7  
 setting the marker, 5-8  
 setting the span, 5-7  
 SGL SWP, 7-45  
 shipping container, 2-1  
 SHOW OPTIONS, 7-45  
 SIGNAL TRACK, 6-9, 7-45  
 signal tracking, 6-7  
 single sweep, 7-45, 7-47  
 SLOPE, 5-33, 7-45  
 soft carrying case (Option 042), 1-3  
 softkey label, 5-2  
 softkeys, 5-2  
 source power, 7-46  
 SPAN, 5-2, 5-7, 7-45  
 SPAN ZOOM, 6-9, 7-46  
 SPEAKER ON OFF, 7-46  
 specifications for the HP 8591A, 1-9-13  
 specifications for the HP 8593A, 1-22-26  
 SPECTRUM ANALYZER, 7-46  
 spectrum analyzer auto-coupled sweep time, 7-47.  
     *See also* SWP CPLG SR SA  
 SQUELCH, 6-43, 7-46  
 SRC ATN MAN AUTO, 7-46  
 SRC PWR OFFSET, 7-46  
 SRC PWR ON OFF, 6-36, 7-46  
 SRC PWR STP SIZE, 7-46  
 SRQ, B-1  
 START FREQ, 7-46  
 start frequency, 7-46  
 STATE -> CARD, 7-47  
 STATE -> INTRNL, 7-47  
 status byte, B-1  
 status byte definition, B-1  
 step keys, 5-3, 7-53  
 stimulus-response, 6-34  
 stimulus response mode, 7-47. *See also* SWP  
     CPLG SR SA  
 STOP FREQ, 7-47  
 stop frequency, 7-47  
 STP GAIN ZERO, 7-9  
 STUVWX, 7-47  
 SWEEP, 7-47  
 SWEEP CONT SGL, 7-47  
 sweep modes, 5-10  
 SWEEP OUTPUT, 5-5, 7-58  
 SWEEP RAMP, 7-9  
 sweep time, 7-47. *See also* SWP TIME AUTO  
     MAN  
 SWEEP TIME DAC, 7-9  
 SWEEP + TUNE OUTPUT, 5-4, 7-55  
 SWP CPLG SR SA, 6-37, 7-47  
 SWP TIME AUTO MAN, 7-47

## T

TG UNLVL message, 6-41  
 third-order intermodulation distortion, 6-24  
 THRESHLD ON OFF, 7-48  
 threshold line, 7-48  
 TIMEDATE, 7-48  
 TIMEDATE ON OFF, 7-48  
 title. *See* CHANGE TITLE  
 TRACE, 7-48  
 TRACE A, 7-48  
 TRACE A B C, 7-48  
 TRACE B, 7-48  
 TRACE C, 7-48  
 TRACE -> CARD, 7-48  
 TRACE -> INTRNL, 7-49  
 trace modes, 5-10  
 TRACK GEN, 6-36, 7-49  
 tracking generator, 7-49  
     external leveling input, 5-5, 7-57  
     frequency adjustment, 7-33  
     internal/external leveling, 7-12  
     normalization, 6-39  
     operation, 6-34  
     output, 5-3, 7-55  
     output power, 7-46  
     peak response, 7-49  
     power sweep, 7-41  
     power sweep range, 7-46  
     self-calibration, 7-16  
     self-calibration routine, 5-13  
     source attenuator, 7-46  
     source power level step size, 7-46  
     source power offset, 7-46  
     stimulus-response, 6-34  
     warm-up time, 5-13  
 tracking generator (Option 010 or 011), 1-2  
 tracking generator self-calibration routine, 2-8  
 tracking peak  
     automatic adjustment, 6-38  
     manual adjustment, 6-38  
 TRACKING PEAK, 6-39, 7-49  
 transit case, 1-7  
 TRIG, 7-49  
 trigger, 7-49  
     external, 7-29  
     free run, 7-30  
     line, 7-32  
     video, 7-51  
 trigger modes, 5-10  
 turning on the analyzer for the first time, 2-7  
 TV LINE #, 7-49  
 TVSTND, 6-45, 7-49  
 TV SYNC NEG POS, 7-49  
 TV trig

- even field, 7-50
- NTSC video format, 7-36
- odd field, 7-50
- PAL-M video format, 7-36
- PAL video format, 7-36
- SECAM-L video format, 7-44
- TV line number, 7-49
- TVSTND, 7-49
- TV sync, 7-49
- vertical interval, 7-50
- TV TRIG, 6-43, 7-50
- TV TRIG EVEN FLD, 6-44, 7-50
- TV triggering, 6-43
- TV TRIG ODD FLD, 7-50
- TV TRIG OUT, 7-58
- TV TRIG OUTPUT, 5-5
- TV TRIG VERT INT, 7-50

## U

- underscore, 7-51
- unit key pressed, B-1
- universal HP-IB service request, B-1
- upper and lower limit line, 5-31
- upper limit line, 5-31
- user-created error messages, A-1
- USER MENU(S), 7-50
- using limit-line functions, 5-27-37

## V

- VBW/RBW RATIO, 7-50
- VERIFY TIMEBASE, 7-50
- VID AVG ON OFF, 7-50
- VID BW AUTO MAN, 7-50

- VIDEO, 7-51
- video averaging, 6-20, 7-50. *See also* VID AVG ON OFF
- video bandwidth, 7-50. *See also* VID BW AUTO MAN
- VIEW A, 7-51
- VIEW B, 7-51
- VIEW C, 7-51
- VOL-INTEN, 5-3, 7-53
- VOLTAGE SELECTOR, 5-4, 7-55
- Volts, 7-51
- volume control, 5-3, 7-53

## W

- warm-up time, 5-12
- warranty, 8-3
- Watts, 7-51
- when self-calibration is needed, 5-14

## X

- X FINE TUNE DAC, 7-9

## Y

- YTF DRIVER, 7-10
- YTF self-calibration routine, 2-9, 5-14
- YTF SPAN, 7-9
- YTF TUNE COARSE, 7-10
- YTF TUNE FINE, 7-10
- YZ-# SPC CLEAR, 7-51

## Z

- ZERO SPAN, 6-7, 7-51

# HP 8591A/8593A SPECTRUM ANALYZER MODE MENU

## AMPLITUDE

REF LVL  
ATTEN, AUTO MAN  
SCALE, LOG LIN  
PRESEL, PEAK\*  
PRESEL, DEFAULT\*  
MORE, 1 of 2

MAX MxR, LEVEL  
AMPTD, UNITS  
EXT, PREAMP  
INPUT Z, 50 75  
REF LVL, OFFSET  
MORE, 2 of 2

dBm  
dBmV  
dBuV  
Volts  
Watts

\* HP 8593A only

## AUX CTPL

DEMOD\*  
TRACK, GEN†  
AUX CONN, CONTROL  
COMB GEN, ON OFF‡

DEMOD ON OFF\*  
DEMOD, AM FM\*  
SPEAKER ON OFF\*  
SQUELCH\*  
FM GAIN\*  
DWELL, TIME\*

SRC PWR, ON OFF†  
TRACKING, PEAK†  
MAN TRK, ADJUST†  
PWR SWP, ON OFF†  
SRC ATN, MAN AUTO†  
MORE, 1 of 2

SRC PWR, STP SIZE†  
SRC PWR, OFFSET†  
ALC MTR, INT XTAL†  
SWP CPLG, SR SA†  
MORE, 2 of 2

CNTL A, 0 1  
CNTL B, 0 1  
CNTL C, 0 1  
CNTL D, 0 1  
---  
DISPLA, CNTL 1

\* Option 102 only  
† HP 8591A, Option 010 or 011 only  
‡ HP 8593A only

## AUTO COUPLE

AUTO, ALL  
RES BW, AUTO MAN  
VID BW, AUTO MAN  
ATTEN, AUTO MAN  
SWP TIME, AUTO MAN  
CF STEP, AUTO MAN

## CAL

CAL FREQ, & AMPTD  
CAL, FREQ  
CAL, AMPTD  
CAL, rTF\*  
CAL, STORE  
MORE, 1 of 3

CONF. TEST  
CAL, FETCH  
CORRECT, ON OFF  
CRT VERT, POSITION  
CRT HORZ, POSITION  
MORE, 2 of 3

SERVICE, CAL  
SERVICE, DIAG  
DEFAULT CAL DATA  
CAL, TRF GEN‡  
VERIFY, TIMEBASE  
MORE, 3 of 3

---  
EXECUTE, TITLE  
FLATNESS, DATA  
CAL TIMEBASE  
CAL MxP\*  
SET ATTN, ERROR

## BW

RES BW, AUTO MAN  
VID BW, AUTO MAN  
VBW/RBW, RATIO  
VID AVG, ON OFF  
9 kHz, EMI BW  
120 kHz, EMI BW

DISPLAY, CAL DATA  
DACS  
STP GAIN ZERO  
AUXA  
AUXB†  
MORE 1

2v REF, DETECTOR  
GND REF, DETECTOR  
MAIN, COIL DR  
FM COIL, DRIVE  
FM SPAN  
MORE 2

MAIN, SPAN  
SWEEP, RAMP  
SWEEP, TIME DAC  
COARSE, TUNE DAC  
BINARY SPAN‡  
MORE 3

EDIT, FLATNESS  
---  
---  
---  
---  
EXIT

FINE, TUNE DAC  
\* FINE, TUNE DAC  
+10V REF, DETECTOR  
-10V REF, DETECTOR  
DROOP  
MORE 4

FREQ, DIAG  
SETPLL, OUTDAC  
FREQ DISC, NORM OFF  
FM, GAIN§  
FM, OFFST§  
MORE 5

YTF TUNE, COARSE\*  
YTF TUNE, FINE\*  
YTF, DRIVER\*  
MIXER, BIAS DAC\*  
PRESEL, DAC\*#  
MORE 6

\* HP 8593A only  
† HP 8591A only  
‡ Changes to YTF, SPAN for HP 8593A  
§ Option 102 only  
|| HP 8591A, Option 010 or 011 only  
# Changes to ALC TEST for an HP 8591A with Option 010 or 011.



**CONFIG**

(LOCAL)

COPY DEV, PRNT PLT\*  
 PLOT, CONFIG\*  
 PRINT, CONFIG\*  
 TIMEDATE  
 CHANGE, PREFIX  
 MORE, 1 of 2

PLTS/PG, 1 2 4\*  
 PLT [ ] LOC [ ] §  
 PLOTTER ADDRESS\*  
 ---  
 PREV. MENU\*

B&W, PRINTER\*  
 PAINTJET, PRINTER\*  
 PRINTER, ADDRESS\*  
 PRT MENU, ON OFF\*  
 PRINTER, SETUP\*  
 PREV. MENU\*

TIMEDATE, ON OFF  
 DATEMODE, MDY DMY  
 SET, TIME  
 SET, DATE  
 ---  
 PREV. MENU

ABCDEF  
 GHIJKL  
 MNOPQR  
 STUVWX  
 YZ\_# SPC, CLEAR  
 MORE, 1 of 2

CARD, CONFIG  
 DISPOSE, USER MEM  
 ANALYZER, ADDRESS†  
 DEFAULT, CONFIG  
 SHOW, OPTIONS‡  
 MORE, 2 of 2

**DISPLAY**

DSP LINE, ON OFF  
 THRESHLD, ON OFF  
 CHANGE, TITLE  
 CHANGE, PREFIX\*  
 GRAT, ON OFF  
 ANNOTATN, ON OFF

ABCDEF  
 GHIJKL  
 MNOPQR  
 STUVWX  
 YZ\_# SPC, CLEAR  
 MORE, 1 of 2

( ) : : :  
 + < > =  
 / ? \ [ ]  
 @ # \$ % & \*  
 ---  
 PPG, TITLE\*  
 MORE, 2 of 2

\* Blanked when CHANGE, PREFIX\* is selected

\* Option 021 or 023 only

† Option 021 only Changes to BAUD, RATE for Option 023

‡ Change to EXIT, SHOW when SHOW, OPTIONS is pressed

§ Appears if 2 or 4 plots per page are selected.

**FREQUENCY**

CENTER, FREQ  
 START, FREQ  
 STOP, FREQ  
 CF STEP, AUTO MAN  
 FREQ, OFFSET

**MEAS/USER**

USER, MENU(S)  
 FFT, MEAS  
 3 dB, POINTS  
 6 dB, POINTS  
 LIMIT, LINES  
 MORE, 1 of 2

NO USER, MENU  
 RECALL, LIMIT  
 SAVE, LIMIT  
 CHANGE, TITLE  
 LIMITS, ON OFF  
 EDIT, LIMIT  
 NEW, LIMIT

99%, PWR BW  
 %, AM  
 3rd ORD, MEAS  
 DELTA, MEAS  
 PK-PK, MEAS  
 MORE, 2 of 2

ABCDEF  
 GHIJKL  
 MNOPQR  
 STUVWX  
 YZ\_# SPC, CLEAR  
 MORE, 1 of 2

LIMITS, FIX REL  
 EDIT, UPPER  
 EDIT, LOWER  
 EDIT, UP/LOW  
 EDIT, MID/DELT  
 PREV, MENU

( ) : : :  
 + < > =  
 / ? \ [ ]  
 @ # \$ % & \*  
 ---  
 RPG, TITLE  
 MORE, 2 of 2

SELECT, SEGMENT  
 SELECT, FREQ  
 SELECT, AMPLITUDE  
 SELECT, TYPE  
 EDIT, UPR LWR  
 MORE, 1 of 2

SELECT, SEGMENT  
 SELECT, FREQ  
 SELECT, UPR AMPL  
 SELECT, LWR AMPL  
 SELECT, TYPE  
 MORE, 1 of 2

SELECT, SEGMENT  
 SELECT, FREQ  
 SELECT, MID AMPL  
 SELECT, DLT AMPL  
 SELECT, TYPE  
 MORE, 1 of 2

LIMITS, FIX REL  
 SELECT, SEGMENT  
 DELETE, SEGMENT  
 EDIT DONE\*  
 PURGE, LIMITS  
 MORE, 2 of 2

SLOPE  
 FLAT  
 POINT  
 ---  
 ---  
 PREV, MENU

\* Returns to the menu accessed by LIMIT, LINES

**MKR**

MARKER, NORMAL  
 MARKER, DELTA  
 MKR CNT, ON OFF  
 MKR NOISE, ON OFF  
 MARKERS, OFF  
 MOPE, 1 of 2

MKPAUSE, ON OFF  
 MARKER, AMPTD  
 CNT RES, AUTO MAN  
 PK-PK, MEAS  
 ---  
 MOPE, 2 of 2

**MKR->**

MARKER, ->CF  
 MARKER, ->REF LVL  
 MARKER ->CF STEP  
 MKR Δ, ->SPAN  
 MINIMUM, ->MARKER  
 PEAK, MENU\*

\* Accesses PEAK, SEARCH menu

**MODE**

PRESET SPECTRUM\*

\* Switches to the PRESET menu

**PRESET**

SPECTRUM, ANALYZER -> PRESET SPECTRUM

**PEAK SEARCH**

MARKER, ->CF  
 MARKER, DELTA  
 NEXT, PEAK  
 NEXT PK, RIGHT  
 NEXT PK, LEFT  
 PEAK, EACUPSN

**RECALL\***

**SAVE\***

INTRNL, ->STATE  
 INTRNL, ->TRACE  
 ---  
 CATALOG, INTRNL  
 INTRNL, CRD

STATE, ->INTRNL  
 TRACE, ->INTRNL†

TRACE A  
 TRACE B  
 TRACE C  
 LIMIT, LINES  
 AMPLTUD, COR FACT  
 PREV, MENU

SAV LOCK, ON OFF  
 CATALOG, INTRNL  
 INTRNL, CRD

CATALOG, ALL  
 CATALOG, REGISTER‡  
 CATALOG, VARIABLES  
 ---  
 CATALOG, PREFIX  
 MORE, 1 of 2

DELETE, FILE  
 ---  
 EXIT, CATALOG  
 PREV, MENU

CATALOG, DLP  
 ---  
 CHANGE, PREFIX  
 EXIT, CATALOG  
 MORE, 2 of 2

ABCDEF  
 GHIJKL  
 MNOPQR  
 STUVWX  
 rZ.# SPC, CLEAR  
 MORE, 1 of 2

( )  
 +<>=  
 /?<>=  
 0#<>=  
 ---  
 MORE, 2 of 2

\* For saving and recalling data from analyzer memory

† Becomes MEM, LOCKED when SAV LOCK is on

‡ CATALOG, REGISTER accesses LOAD, FILE instead of DELETE, FILE

**RECALL\***

**SAVE\***

CARD, ->STATE  
 CARD, ->TRACE  
 ---  
 CARD, ->DLP  
 CATALOG, CARD  
 INTRNL, CRD

STATE, ->CARD  
 TRACE, ->CARD  
 ---  
 ALL DLP, ->CARD  
 CATALOG, CARD  
 INTRNL, CRD

TRACE A  
 TRACE B  
 TRACE C  
 LIMIT, LINES  
 AMPLTUD, COR FACT  
 PREV, MENU

CATALOG, ALL  
 CATALOG, STATES  
 CATALOG, TRACES  
 ---  
 CATALOG, PREFIX  
 MORE, 1 of 2

LOAD, FILE  
 ---  
 DELETE, FILE  
 ---  
 EXIT, CATALOG  
 PREV, MENU

CATALOG, DLP  
 CATALOG, AMP CORP  
 CATALOG, LMT LINE  
 CHANGE, PREFIX  
 EXIT, CATALOG  
 MORE, 2 of 2

ABCDEF  
 GHIJKL  
 MNOPQR  
 STUVWX  
 rZ.# SPC, CLEAR  
 MORE, 1 of 2

( )  
 +<>=  
 /?<>=  
 0#<>=  
 ---  
 MORE, 2 of 2

\* For saving and recalling data from the memory card

SIGNAL  
TRACK

SPAN

SWEEP

SPAN  
SPAN, ZOOM  
FULL, SPAN  
ZERO, SPAN  
BAND, LOCK\*

0-2 9 Gz, BAND 0\*  
2 75-6 4, BAND 1\*  
6 0-12 8, BAND 2\*  
12 4-19, BAND 3\*  
19 1-22, BAND 4\*  
BND LOCK, ON OFF\*

\* HP 8593A only

SWP TIME, AUTO MAN  
SWEEP, CONT SGL

TRACE

TRIG

CLEAR, WRITE A  
MAX, HOLD A\*  
VIEW, A  
BLANK, A  
TRACE, A B C  
MORE, 1 of 3

VID AVG, ON OFF  
DETECTOR, SAMPL PK  
NORMLIZE, ON OFF  
NORMLIZE, POSITION  
A <-> B  
MORE, 2 of 3

A-B -> A, ON OFF  
B-DL -> B  
B <-> C  
A -> C  
B -> C  
MORE, 3 of 3

\* Changes to MIN, HOLD C when trace C is selected

SWEEP, CONT SGL  
FREE RUN  
VIDEO  
LINE  
EXTERNAL  
TV TRIG\*

TV, LINE #\*  
TV TRIG, ODD FLD\*  
TV TRIG, EVEN FLD\*  
TV TRIG, VERT INT\*  
TV SYNC, NEG POS\*  
TVSTND\*

NTSC\*  
PAL-M\*  
PAL\*  
SECAM-L\*  
---  
PREV, MENU\*

\* Option 102 only